

kramer | zeevee™

ZyPer4K

4K IP Video Distribution System

User Manual

Updated January 2025



Document symbol conventions:



Indicates an important piece of information affecting the operation of the unit. Retain this information.



Indicates a point of caution. Failure to heed this information may cause a hazard of some form to the operator or others in the field of operation.



Indicates a point regarding the electrical safety of the box. Failure to abide by the information presented may result in an electrical shock hazard to the operator or others in the field of operation.



Indicate a point affecting the RF performance of the box. Failure to heed or abide by the information presented may result in emissions or susceptibility that can affect the unit or nearby equipment. Performance conforming to the regulatory limit may be compromised or affected.

About ZeeVee: (Acquired by Kramer in August 2024)

ZeeVee is the leading manufacturer of high-quality encoder/modulator/decoder products for video distribution over any type of transmission media; be it RF coax, fiber, or copper ethernet.

Established in 2007, ZeeVee has been manufacturing industry-leading products while operating the company responsibly in compliance with the strictest levels of regulatory and environmental requirements. The standards by which we govern our corporate conduct are far higher than that required by law.

Our mission is to completely fulfill the toughest customer application requirements with the highest quality products we can produce. After the sale, we strive to support the customer with award-winning support and service. Our goal is that no customer shall ever be dissatisfied. It is both our mission and our passion.

Kramer, Incorporated
295 Foster Street, Suite 200
Littleton, Massachusetts
01460, USA

www.zeevee.com and www.kramerav.com
zv_support@kramerav.com
Phone: 1-877-493-3833

CONTENTS

- System Description.....1
- System Elements2
 - Encoder Function2
 - Decoder Function.....3
 - Management Platform.....5
 - ZyPer Management Platform Hardware6
- Detailed Interface Descriptions7
 - Encoder7
 - Enclosure variants7
 - Common Ports.....7
 - Optional Ports - 10Gb Ethernet9
 - Optional Ports - USB10
 - Extended Input Options.....11
 - XS Version Encoders18
 - XSE Version Encoders21
 - ZyPer4K-XS/XSE Encoder Reset Pin.....25
 - XR Version Encoders (discontinued).....25
 - ZyPer4K-XR Encoder Mounting Hole and Reset Pin28
 - Wallplate Encoder (US form factor-front)29
 - USB-C Cable Requirements30
 - Wallplate Encoder (US form factor-back)30
 - Wallplate Encoder (EU form factor-front).....33
 - USB-C Cable Requirements34
 - Wallplate Encoder (EU form factor-back)35
 - Important USB-C information37
 - USB-C Cable Requirements.....37

Decoder	38
Enclosure variants.....	38
Common Ports	38
Optional Ports: 10Gb Ethernet.....	40
Optional Ports: USB	41
Optional Ports: Display Port	41
Quiet/Fanless Decoder	42
XS Version Decoders.....	43
XSE Version Decoders	46
ZyPer4K-XS/XSE Decoder Reset Pin.....	50
XR Version Decoders (discontinued).....	51
ZyPer4K-XR Decoder Mounting Hole and Reset Pin.....	54
Wallplate Decoder (US form factor-front).....	55
Wallplate Decoder (US form factor-back).....	56
Wallplate Decoder (EU form factor-front).....	58
Wallplate Decoder (EU form factor-back)	59
Options	61
Other Ports	61
Setting Up ZyPer4K in a Point to Point Environment.....	63
Dante Embedded Platform (DEP)	64
Dante Operation	66
Dante API Commands	69
Setting up ZyPer4K in Many to Many Environment	71
Icron USB Details (Optional Feature most units)	74
USB Details (Standard Feature XS/XR units).....	75
ZyPer4K USB Interoperability	75
Important Note on ZyPer4K-XSE Decoders	76

Technical Specifications	77
Encoder and Decoder HDMI Video Specifications	77
Decoder DisplayPort Video Specifications	78
Physical and Environmental	80
General Safety and Care Instructions	81
Safety	81
Cleaning	83
Encoder, Decoder and ZyPerMP Unit Cleaning Procedures	83
ZyPerMP Specific Cleaning Procedure	84
Important Siting and Application Considerations.....	85
ZyPer4K Equipment Type and Uses	85
Installation Environment.....	86
Mounting Options	86
Mounting Brackets.....	86
VESA Mounting Bracket	89
Ventilation	91
Water and moisture.....	91
AC Mains Connection	92
AC Power Cord	93
Equipotential Referencing.....	94
Installer-Required Action	94
Responsibility and Stewardship	96
Reduction of Hazardous Substances (RoHS).....	96
Waste Electrical and Electronic Equipment.....	97
FCC Compliance Statement.....	98
EMC Information	99
Electromagnetic Emissions	99

Electromagnetic Immunity	100
Physical Dimension Diagrams	101
Appendix 1.....	107
Known Good USB-C Cables	107
Appendix 2.....	108
USB-C Charging	108
USB-C Cable Requirements.....	108
Appendix 3.....	109
PoE Power and PoE Switches.....	109
Why Shielded Ethernet Cable Is Required	110
Appendix 4.....	112
Accessories	112
Appendix 5	114
ZyPer4K Part Numbers	114
Disclaimers	120

System Description

The ZyPer4K series of products from Kramer provide a means for transmitting and receiving up to 4K audio-visual information across a standard 10Gb IP network with outstanding quality at very low latencies.

A minimal system consists of:

- Video Source (Up to 4K)
- ZyPer4K Encoder device
- CatX Cable or Fiber cables with SFP modules
- ZyPer4K Decoder device
- Video sink (display device)

A fully realized system consists of:

- (N) Video Sources (HDMI 2.0 support with HDR)
- (N) ZyPer4K Encoder devices
- 10Gb Ethernet switching Infrastructure (> (N+M) ports of non-blocking capacity)
- (M) ZyPer4K Decoder devices
- (M) Video sink (display devices)
- ZyPerMP control node

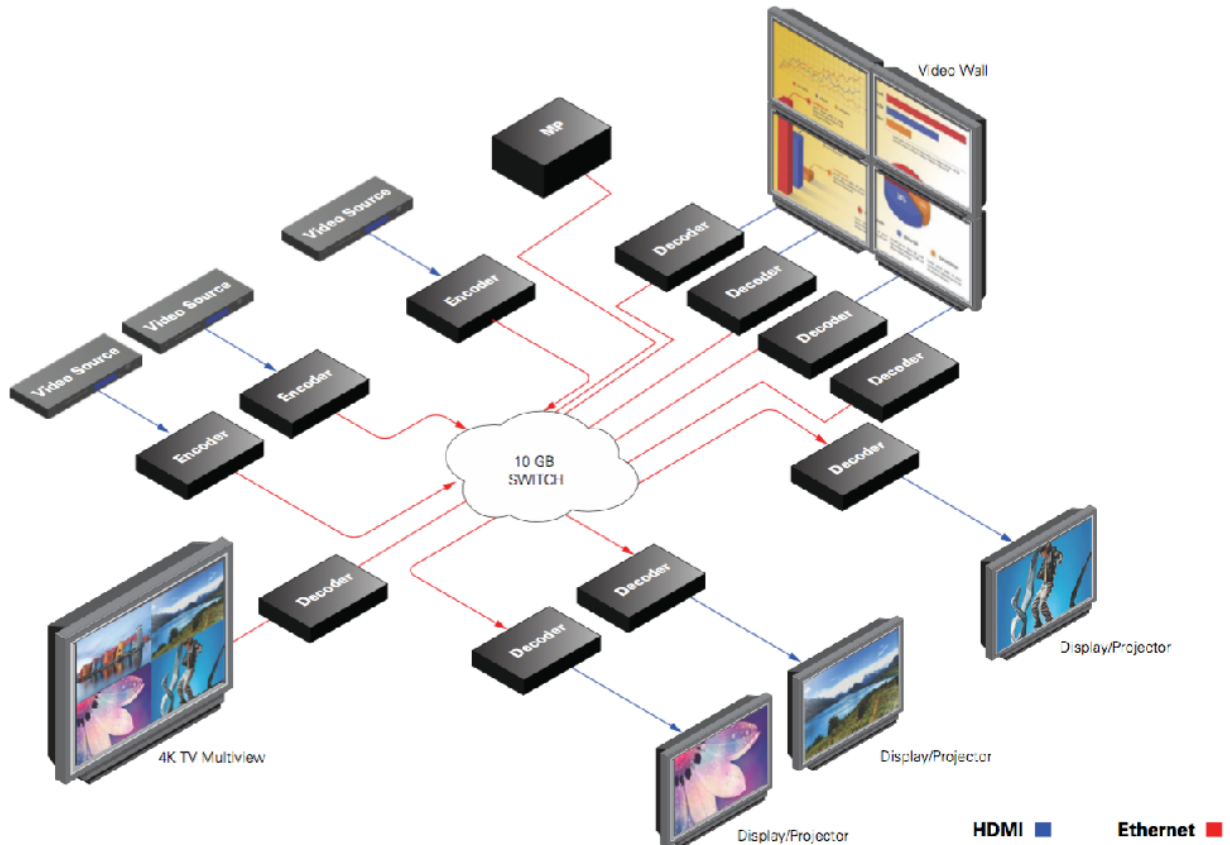

System Elements

Encoder Function

The function of the ZyPer4K Encoder Device (Encoder) is to accept audio and video data over a variety of interface types, and translate that data to a format suitable for transmission over a standard 10Gb Ethernet network.

Video data is segmented, encrypted, prepared for transmission, and sent by the Encoder unit. No unit other than those so designated by the control entity shall be able to receive the video stream sent by an Encoder.

The format of the IP data is fully in compliance with industry-standard IEEE 802.3 Ethernet networking practices. Any switch or device capable of passing 10G Ethernet traffic can be employed to carry ZyPer4K A/V traffic. (See *ZyPer4K Network Requirements and Security Considerations* document)

Other ports on the Encoder devices are for the carriage of USB, IR, RS232 and audio data as well as a 1Gbit/second utility port for general purpose connectivity of devices to the 10G bulk data infrastructure.

Common Interfaces on all Encoders:

- Power Input (12VDC)
 - RS232 Input/Output*
 - 1Gbit/sec Utility Ethernet Port
 - Analog Audio Input
 - Infrared Input and Output*
 - HDMI 2.0 Input
- * Not available on XS, XSE or XR models

Ethernet Bulk Media Interface:

10Gb Fiber *or* 10Gb Copper

Optional Interfaces on Encoder Units:

Video:

USB-C (XSE & Wallplate Encoders only)

USB:

(none) *or*
 USB Type-B Interface
 USB-C (Combo on XSE only)
 Mini USB Type-B (XS units only)

Extended Media Input:

HDMI with loopback *or*
 12G-SDI *or*
 DisplayPort 1.2a *or*
 Analog (YPrPb/VGA/S-Video)

In total there are 26 different, unique Encoder types that can be ordered.

HDMI Fiber	12G-SDI Fiber	DisplayPort Fiber	Analog Fiber discontinued	Dual HDMI with Loopback Fiber
HDMI Fiber with USB	12G-SDI Fiber with USB	DisplayPort Fiber w/USB	Analog Fiber w/ USB discontinued	Dual HDMI with Loopback Fiber w/USB

ZyPer4K

HDMI Copper	12G-SDI Copper	DisplayPort Copper	Analog Copper <i>discontinued</i>	Dual HDMI with Loopback Copper
HDMI Copper with USB	12G-SDI Copper w/USB	DisplayPort Copper w/USB	Analog Copper with USB <i>discontinued</i>	Dual HDMI with Loopback Copper w/USB
XS Copper with USB	XS Fiber with USB	XR Copper with USB <i>discontinued</i>	XR Fiber (multimode) with USB <i>discontinued</i>	XR Fiber (single mode) with USB <i>discontinued</i>
Wallplate w/ Icron USB (US form factor)	Wallplate (US Form factor)	Wallplate w/ Icron USB (EU form factor)	Wallplate (EU form factor)	XSE Copper with USB-C input
XSE Copper with USB-C input and Dante	XSE Fiber with USB-C input	XSE Fiber with USB-C input and Dante		

Note: All ZyPer4K encoders are **TAA Compliant** except for the Wallplate units.

Decoder Function

The function of the ZyPer4K Decoder device (Decoder) is to accept 10G Ethernet traffic that represents the information to be decoded and displayed. When the appropriate IP stream is received the Decoder unit will first strip off the encryption that protects the payload on its transit across the network. It then reformats the video and audio information for display and plays it out its HDMI video output. Audio is also played out the appropriate port as included.

Other ports on the Decoder devices are for the carriage of USB, IR, RS232 and audio data as well as a 1Gbit/second utility port for general purpose connectivity of devices to the 10Gb bulk data infrastructure.

Common Interfaces on all Decoders:

- Power Input (12VDC)
- RS232 Input/Output*¹
- 1Gbit/sec Utility Ethernet Port
- Analog Audio Output
- Infrared Input and Output*²
- HDMI 2.0 Output

*¹ Not available XS or XR models

*² Not available on XS/XSE or XR models

Ethernet Bulk Media Interface:

10Gb Fiber *or* 10Gb Copper

Optional Interfaces on Decoder Units:

DisplayPort

(none) or present

USB:

(none) *or*
2x USB Type-A Interface

ZyPer4K

1x USB Type-A Interface (XS and Rev1 XSE units)

In total there are 18 different, unique Decoder types that can be ordered.

HDMI Fiber	HDMI Fiber with USB	HDMI Copper	HDMI Copper with USB
DisplayPort Fiber	DisplayPort Fiber with USB	DisplayPort Copper	DisplayPort Copper with USB
HDMI Fiber (Quiet/ Fanless) discontinued	HDMI Copper (Quiet/ Fanless) discontinued	HDMI Copper with USB and Dante Transmitter* discontinued	HDMI Fiber with USB and Dante Transmitter* discontinued
XS Copper with USB	XS Fiber with USB	XR Copper with USB discontinued	XR Fiber (multimode) with USB discontinued
XR Fiber (single mode) with USB discontinued	Wallplate w/lcron USB (US form factor)	Wallplate (US form factor)	Wallplate w/lcron USB (EU form factor)
Wallplate (EU form factor)	XSE Copper with RS-232 and USB	XSE Fiber with RS-232 and USB	XSE Copper with RS-232, USB and Dante
XSE Fiber with RS-232, USB and Dante			

Note: All ZyPer4K decoders are **TAA Compliant** except for the Wallplate units.

Management Platform



Most installations will require a ZyPer Management Platform (ZyPerMP). This device controls the operation and manages the connectivity between endpoints. The management platform is a hardened controller node that must reside on the same logical network as the ZyPer4K Encoders and Decoders. It runs a ZeeVee application as its sole function. The application presents an API to potential third party management platforms as well as hosting its own management application.

In point-to-point applications every element is essential. The ZyPer4K Encoder and Decoder will detect this special case and self-configure appropriately.

Any installation beyond simple point-to-point link extension-like applications require a ZyPerMP.

The purpose of the Management Platform is to interface user operational requests into the specific device-level control needed to effect connectivity changes, screen management, interface management, and distribute software and control data to all the endpoints of the overall system. The ZyPerMP is the entity that insures all the endpoints, are accounted for, operating properly, and performing the correct operation at the correct time.

Further, the ZyPerMP is the element that guarantees security, manages access to the overall system and prevents rogue listeners or observers from snooping or spoofing unwanted content.

Multiple ZyPerMP devices may be deployed in a redundant configuration to provide for fault tolerant control of the greater ZyPer4K overall system.

Operation of the ZyPerMP, the Management application, and the ZyPer-API are beyond the scope of this manual and are documented separately in far greater detail in the *ZyPer Management Platform User Manual*. Documentation can be downloaded from the ZeeVee website.

<https://www.zeevee.com/documentation-all-products>

ZyPer Management Platform Hardware

The ZyPer Management Platform (ZMP) is available from Kramer in two different hardware options. NUC and Rack Mount Server. Both versions have two network interfaces. It is important that the port labeled “Video Network” is connected to the LAN containing the ZyPer4K encoder/decoder endpoints. The port labeled “Management Network” is available to separate the Video AV Network from a corporate or Control Network.

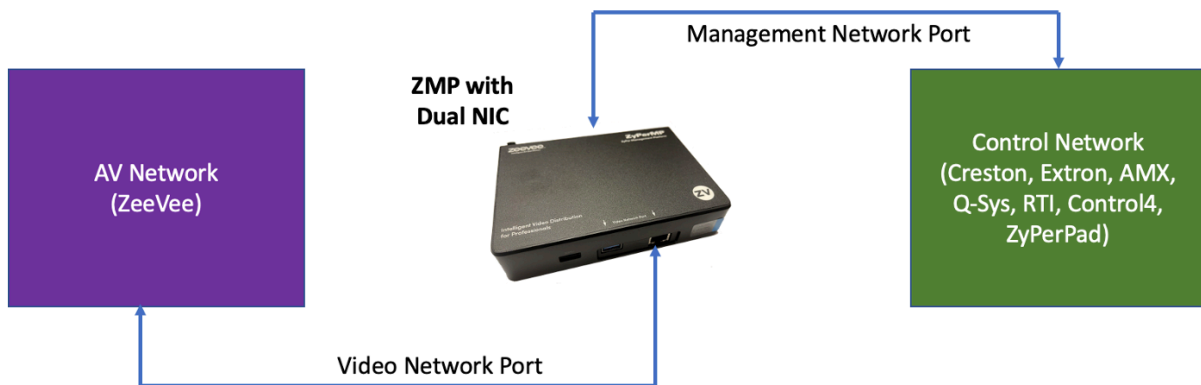
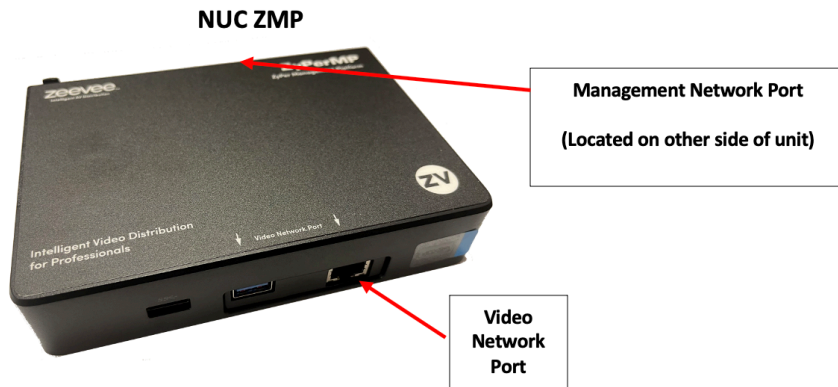
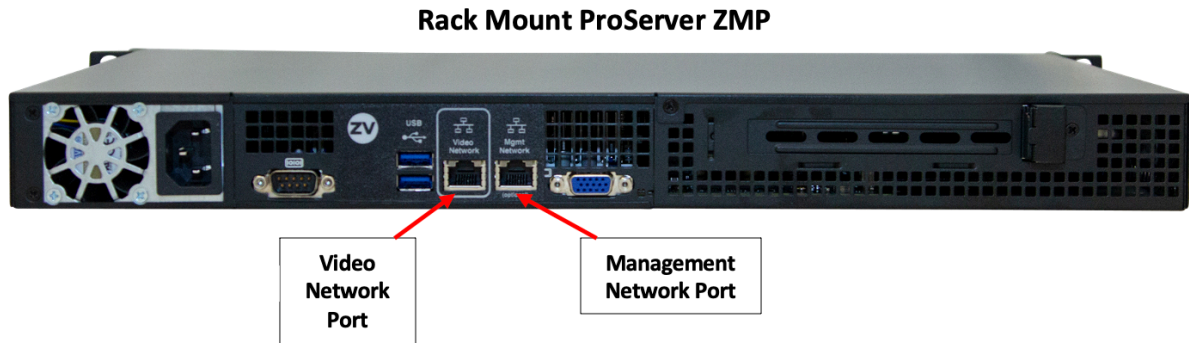

Detailed Interface Descriptions

Encoder

The function of the encoder is to accept raw video images, encode, encrypt and format them for transmission. There are several different variations based on the user's desired input, media type and interface description. The encoder supports inputs up to 4K resolution including full HDMI 2.0 support. (4K resolution 4:4:4 at 60Hz)

Enclosure variants

There are seven different sizes of the ZyPer4K Encoder unit enclosure.

Input Function	Box Size
HDMI Input	Base unit: 175mm Wide x 43mm High x 144mm Deep
HDMI + Opt HDMI and Loop out	Extended unit: 227mm Wide x 43mm High x 144mm Deep
HDMI + HDSDI Input	Extended unit: 227mm Wide x 43mm High x 144mm Deep
HDMI + DisplayPort Input	Extended unit: 227mm Wide x 43mm High x 144mm Deep
HDMI + Analog Video Input	Extended unit: 227mm Wide x 43mm High x 144mm Deep
HDMI Input (XS Version)	199mm Wide x 47mm High x 116mm Deep
HDMI + USB-C (XSE Version)	199mm Wide x 48mm High x 136mm Deep
HDMI Input (XR Version)	220mm Wide x 71mm High x 199mm Deep
US form factor wallplate	US 3-Gang size. 171.5mm Wide x 123.9mm High x 45.9mm Deep (Includes cover plate)
EU form factor wallplate	EU Size. 222.5mm Wide x 86mm High x 45.9mm Deep (Includes cover plate) (UK cover plate available at added cost)

The USB option does not affect the enclosure size.

The type of bulk media (10Gb Fiber or 10Gb Copper) does not affect the enclosure size.

Common Ports

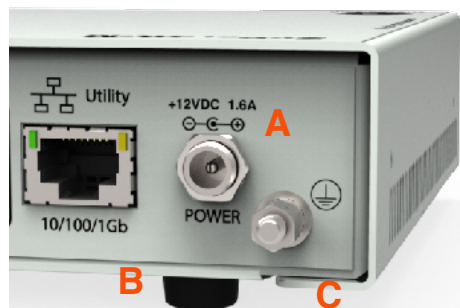

The following ports are common to all non-wallplate encoders, regardless of the options or enclosure variant. (Except XS/XSE/XR units)

ZyPer4K

Port Name	Index	Definition
Power	A	12VDC from supply. Center Post is + Ring is -
Utility Network	B	10/100/1000Base-T Ethernet port. Used for general purpose device attachment to network. Traffic will be switched on to media network.
Ground Lug	C	For equipotential referencing of the box, this lug may be connected the environmental ground using a customer-supplied ground lead.

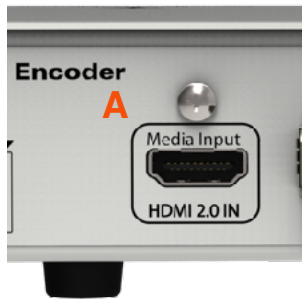

Port Name	Index	Definition
HDMI Input	A	HDMI 2.0 Input port. Capable of up to 4K60 with HDCP2.2 encryption.



Port Name	Index	Definition
RS 232 Port	A	RS232 Control Port for sending and receiving side-band serial traffic to/from decoders as directed by ZyPer Management Platform (ZMP)
LED PWR	B	LED illuminated when unit is powered
LED VID	C	LED Illuminated when active video is being processed

Port Name	Index	Definition
Audio	D	Audio Input/Output Jack. Input or Output of line-level stereo audio on 3.5mm jack. Direction of port configured by ZMP.
IR-OUT	E	Infrared commands information passed back FROM decoders as configured by ZMP. Note: Must use ZeeVee part number Z4KIRTX
IR-IN	F	Infrared commands to be passed TO decoders as configured by ZMP. Note: Must use ZeeVee part number Z4KIRRX
RESET	G	Reset to factory defaults. Disconnect power. Delete unit from ZMP GUI. Using a wire or paper clip, lightly press into this hole while powering on the unit. Hold for 15 seconds to reset the unit to factory defaults.

Optional Ports - 10Gb Ethernet

The customer may choose which type of Ethernet interface is appropriate for the application being addressed. Only one is present at a time and either is available regardless of the enclosure size.

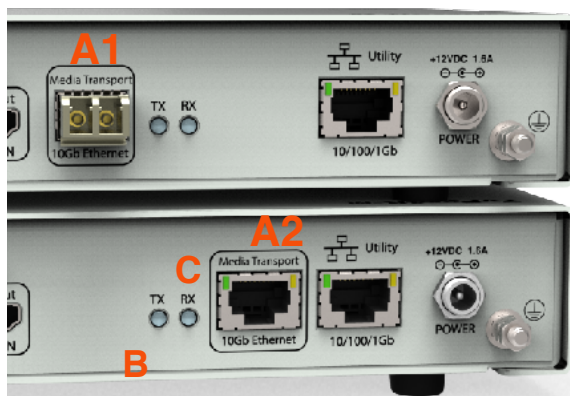

Port Name	Index	Definition
10G Fiber	A1	10 Gigabit Ethernet Connection. Uses standard 10Gb pluggable devices SFP devices.
10G Copper	A2	10Gb Ethernet over Cat6a (or better) cabling. RJ45
TX Activity	B	Blue LED illuminates in synchrony with the transmission of 10Gb Ethernet data
RX Activity	C	Blue LED illuminates in synchrony with the receipt of 10Gb Ethernet data

Optional Ports - USB

ZyPer4K Encoder units are available with or without a USB port.

Note: Information below does not pertain to XS/XSE/XR Encoder units.



Port Name	Index	Definition
USB	A	USB 2.0 Type B port. Configuration and routing of USB handled by the ZMP configuration. Lower unit shown with no USB installed.

Important Note

The USB system requires its own IP Address that is different and independent from the IP Address of the ZyPer4K itself. Therefore a ZyPer4K unit with integrated USB needs two IP addresses. Customers that are using a DHCP server to generate IP Addresses must ensure the pool of available IP Addresses accounts these extra devices needing IP Addresses in the system.

If no DHCP server is available, the USB controller will assign itself a Link-Local address. However, if there is a DHCP server, but there are not enough addresses available in the pool, USB connections may fail.

There is no means of setting the USB controller with a Static IP address.

Extended Input Options

All Encoder units contain a single HDMI 2.0 input port. Optionally, units may be ordered with an “extended” input. Units so ordered will reside in a somewhat larger enclosure.

Available interface types are shown:

(note: All input types are available with either 10Gb Fiber or 10Gb Copper Ethernet ports)

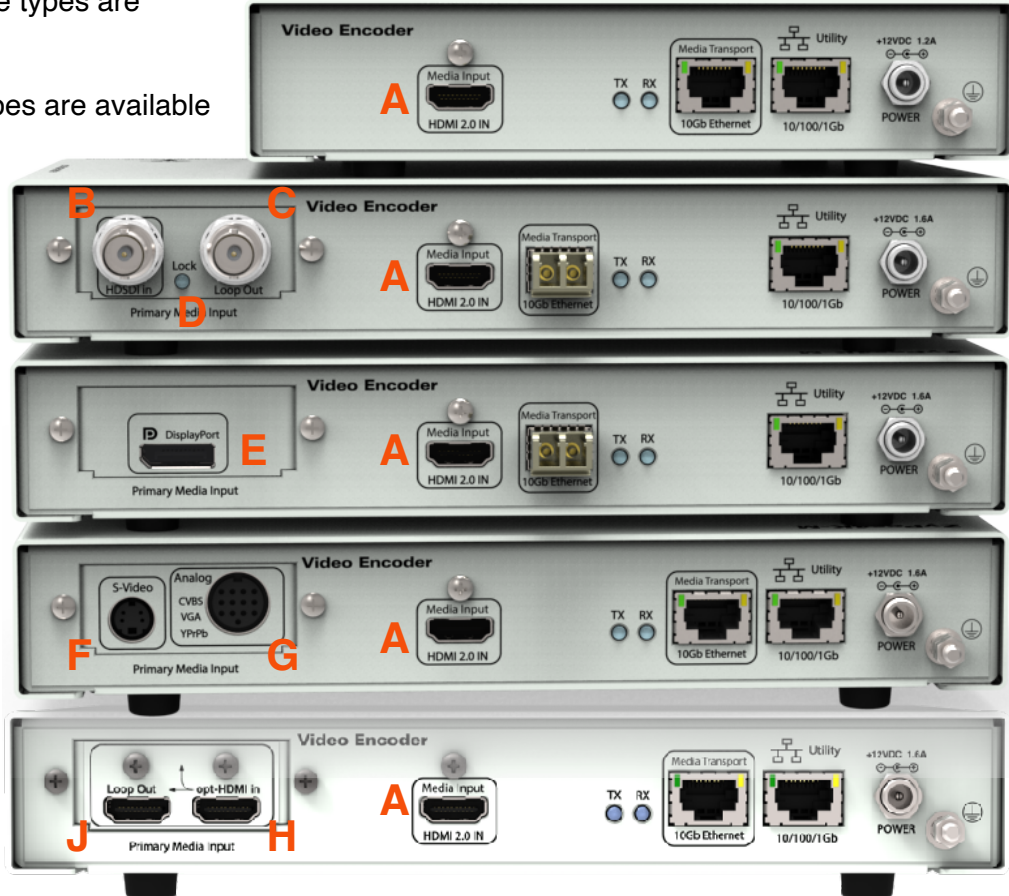

Port Name	Index	Definition
HDMI 2.0	A	All encoders contain an HDMI 2.0 port capable of up to 4KP60 4:4:4 with embedded audio and HDCP 2.2 encryption.
12G-SDI Input	B	12G-SDI Input supports up to 2160P60 w/up to 16-channels of embedded audio.
12G-SDI Loop	C	Copy of 12G-SDI Input port, retimed and re-amplified and presented for downstream devices.
LOCK LED	D	Blue LED illuminated when receiving valid SDI input
DisplayPort 1.2a	E	Standard DisplayPort 1.2a Input supporting up to 4K60 input rate with embedded audio.
S-Video	F	Standard S-Video video input. NTSC and PAL supported. Use STD cable.

Port Name	Index	Definition
ZeeVee Hydra Connection	G	13-Pin High density DIN connector allows for all signals related to Analog Video to be input. Types of Hydra Cable supported: <ul style="list-style-type: none"> Analog Video (YPrPb + S/PDIF + CVBS + LR Audio) VGA Video (HD15 VGA input + LR Audio)
Optional HDMI 2.0 Input	H	Secondary or Optional HDMI port capable of up to 4KP60 4:4:4 with embedded audio and HDCP 2.2 encryption.
HDMI Loop Out	J	Direct loop out of the Optional HDMI input. Index H above. Note: HDMI Input A cannot be directed to the Loop out port.

Dual HDMI Input with Loop Out Option

The ZyPer4K Encoder may be purchased with the “Optional HDMI input with Loop-Out” pre-installed at the factory.

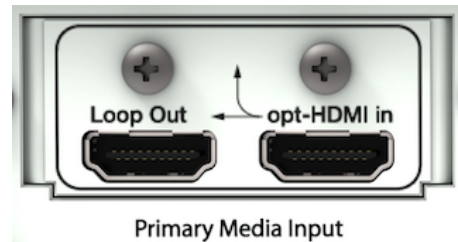

Type	Parameter
Dual HDMI with Loop Out Option	Secondary or Optional HDMI port capable of up to 4KP60 4:4:4 with embedded audio and HDCP 2.2 encryption.
Direction	opt-HDMI in = Input, Loop Out = Output
Resolutions	Same complete set of resolutions as supported by the resident HDMI module on the core Encoder unit.
Audio	Up to 8-channels of LPCM audio can be received on the opt-HDMI interface.

Important Notes:

The ZyPer Management Platform (ZMP) is used to select what input is active for the Dual HDMI input encoder. The command is “set device videoPort”. The available options and results are:

auto: If only one input has a source connected, that input will be used as input for the encoder. If both inputs have sources connected, then the right HDMI input will be used as the active input for the encoder.

hdmi: If HDMI is selected then the right most HDMI input will be used as the source for the encoder.

hdmiOptionalIn: If *HDMIOptionalIn* is selected, the left HDMI port labeled “opt-HDMI-in” above the “Primary Media Input” label will be used as the source for the encoder.

DisplayPort Input Option

The ZyPer4K Encoder may be purchased with the “DisplayPort Input Option” pre-installed at the factory.

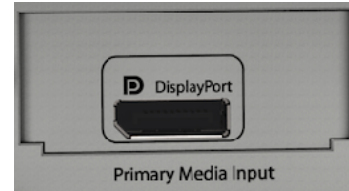

Type	Parameter
DisplayPort Option	Single DisplayPort receptacle support v1.2a of the DisplayPort standard.
Direction	Input
Resolutions	Same complete set of resolutions as supported by the resident HDMI module on the core Encoder unit.
DRM	HDCP 2.2 only (DPCP not supported)
Audio	Up to 8-channels of LPCM audio can be received on the DisplayPort interface.

Important Notes:

The ZyPer Management Platform (ZMP) is used to select what input is active for the dual input encoder with DisplayPort option. The command is “set device videoPort”. The available options and results are:

auto: If only one input has a source connected, that input will be used as input for the encoder. If both inputs have sources connected, then the DisplayPort input will be used as the active input for the encoder.

hdmI: If HDMI is selected then HDMI input will be used as the source for the encoder.

displayPort: If display-port is selected, the DisplayPort input will be used as the source for the encoder.

“12G-SDI” Option

The ZyPer4K Encoder can be purchased with the commonly referred-to “12G-SDI Option”. **Note that the 3G-SDI Option has been discontinued as of mid 2023.**

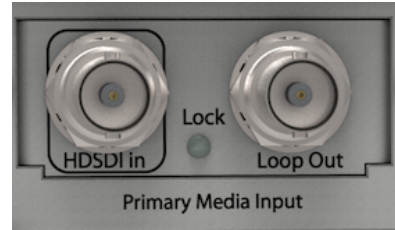

Type	Parameter
12G-SDI Option	Single Input port supporting the following standards: ST425-5, ST2081-11, ST2082-10 (Note 3G-SDI Level B “Dual Link” is not supported)
LoopThrough	Retimed, re-amplified, direct-copy of the input signal provided on the “Loop” port for downstream chaining of the 12G-SDI input. ST2082-1 compatible.
Data Rates	1.485Gb/s, 1.485/1.001Gb/s, 2.97Gb/s, 2.97/1.001Gb/s, 5.94Gb/s, 5.94/1.001Gb/s, 11.88Gb/s, and 11.88/1.001Gb/s
Connectors	75-ohm BNC-type connector (input and output)
Cable Lengths	Canare L-5.5CUHD up to 75m. Belden 1694A up to 30m at 12G SDI. Both will work up to 100m at 3G SDI.
Format	Level-A <i>Level-B Dual Link Mapping (B-DL) is NOT supported</i> <i>Dual Stream (B-DS) mapping is NOT supported.</i>
Resolutions	<ul style="list-style-type: none"> • 12G <ul style="list-style-type: none"> ○ 4096x2160 p 60/59.94/50 ○ 3840x2160 p 60/59.94/50 • 6G <ul style="list-style-type: none"> ○ 4096x2160 p 30/29.97/25/24/23.98 ○ 3840x2160 p 30/29.97/25/24/23.98 • 3G <ul style="list-style-type: none"> ○ 1920x1080 p 60/59.94/50 ○ 2048x1080 p 60/59.94/50 • HD <ul style="list-style-type: none"> ○ 2048x1080 p 30/29.97/25/24/23.98 ○ 1920x1080 p 30/29.97/25/24/23.98 ○ 1920x1080 i 60/59.94/50 ○ 1280x720 p 60/59.94/50/30/29.97/25 <p>All using 4:2:2 subsampling</p>
Audio	16-channels of SMPTE299M audio Note: Restricted to 2-channels in Genlock mode

ZyPer4K

Important Notes:

The ZyPer Management Platform (ZMP) is used to select what input is active for the dual input encoder with HD-SDI or 12G-SDI option. The command is “set device videoPort”. The available options and results are:

hdmi: If HDMI is selected then HDMI input will be used as the source for the encoder.

hdsdi: If HDSDI is selected, the HD-SDI input will be used as the source for the encoder.

12gsdi: If 12GSDI is selected, the 12G-SDI input will be used as the source for the encoder.

Analog Option

The ZyPer4K Encoder can be purchased with the “Analog Input Option”. This provides for four different types of possible video input (only one input active at a given time).

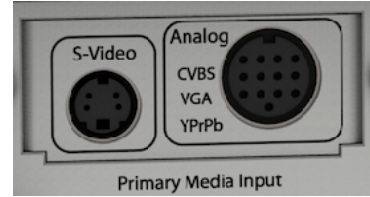

Type	Parameter
Analog Input Option	4 different types of Analog video input supported.
S-Video	Standard 4-pin mini-DIN S-Video input Supports 480i and 576i resolutions (NTSC and PAL)
CVBS	<i>Composite Video. Standard RCA plug spawned from ZeeVee Hydra cable connected to 13-pin DIN connector. Supports 480i and 576i resolutions (NTSC and PAL)</i>
YPrPb	Standard Component Video input provided through Red, Green and Blue RCA connectors spawned by the ZeeVee Hydra Cable connected to the 13-Pin DIN connector. 640x480 (p/i) 720x576 (25Hz/50Hz)(p/i) 1280x720 (p/i) 1280x1024 (p) 1920x1080 (p/i) all at 24/25/29.97/30/50/59.94/60Hz refresh rates except where noted
VGA	A standard 15-Pin HD DSUB male VGA connector is provided through the use of the appropriate ZeeVee Hydra cable connected to the 13-PIN DIN connection on the rear pos the unit. 640x480 (p) 720x576 (p) 800x600 (p) 1024x768 (p) 1280x720 (p) 1280x1024 (p) 1366x768 (p) 1440x1080 (p) 1600x1200 (p) 1920x1080 (p)
Analog Audio (RCA-type DIN cable)	2-channels of line-level L/R analog stereo input through the Red/White plug spawned by the appropriate ZeeVee Hydra cable connected to the 13-pin DIN jack.
Analog Audio (VGA-type DIN cable)	2-channels of line-level L/R analog stereo input through 3.5mm plug spawned by the VGA version of the ZeeVee Hydra cable connected to the 13-Pin DIN jack.

Type	Parameter
Digital Audio	When S/PDIF connection of the ZeeVee Hydra analog breakout cable is employed, received audio can be 2-channels of LPCM, or digitally encoded. If digitally encoded audio is received, it will be passed through unmodified through the Z4K system to the decoders (see HDMI Port specification).

Important Notes:

The ZyPer Management Platform (ZMP) is used to select what input is active for the dual input encoder with Analog option. The command is “set device videoPort”. The available options and results are:

hdmi: If HDMI is selected then HDMI input will be used as the source for the encoder.

component: If Component is selected, the Analog input will be used as the source for the encoder. See Analog breakout cable below.

composite: If Composite is selected, the Analog input will be used as the source for the encoder. See Analog breakout cable below.

vga: If VGA is selected, the Analog input will be used as the source for the encoder. See VGA breakout cable below.

s-video: If S-Video is selected, the S-Video input will be used as the source for the encoder. Note that S-Video does not support audio.

ZyPer4K

Two different variants of the Hydra breakout cable may be purchased separately for use in the specific user application

VGA BREAKOUT

- HD-15 supporting numerous resolutions up to 1900x1600
- Analog audio input carrying stereo L/R line-level audio for transport.



Analog Breakout

Following connections supported:

- YPrPb - resolutions up to 1080P60
- CVBS - PAL and NTSC resolutions
- S/PDIF - digital audio input
- Analog L/R stereo line-level audio



When using the Analog breakout, only ONE of the input types (YPrPb or CVBS) may be active at a given time.

Similarly, only one type of audio input (S/PDIF or L/R Stereo) may be active at a given time.

XS Version Encoders

XS version encoders provide a smaller footprint alternative as well as silent fanless operation. Note that XS version encoders and standard encoders/decoders are compatible with each other with the exception of a few features noted below:

- XS Version encoders do not support RS232 or IR ports.
- XS Version encoders do not support Preview Streams
- XS Version encoders do not support Multiview Text Overlay
- XS Version units USB function is not compatible with standard unit USB units.
- XS Version unit USB does not support cameras.



Note: Removing the rubber ring will void the warranty. The ring provides essential shock protection, unit spacing and is part of the seal that keeps foreign matter out of the unit.

ZyPer4K XS Encoder (Copper)



Port Name	Index	Definition
Power	A	12VDC from supply. Center Post is + Ring is -
10G Copper (PoE)	B	10Gb Ethernet over Cat6a (or better) cabling. RJ45. Supports PoE. Important Note: If using PoE with ZyPer4K units; the ZyPer4K must have a path to the ground. This grounding can be accomplished by using a shielded network cable (F/UTP). Please see Appendix 3 of this manual for additional information.
Utility Network	C	10/100/1000Base-T Ethernet port. Used for general purpose device attachment to network. Traffic will be switched on to media network.
Mini USB-B	D	Mini USB 2.0 Type B port. Configuration and routing of USB handled by the ZMP configuration. (Only compatible with other XS/XSE/XR units)
Audio	E	Audio Input/Output Jack. Drives line-level stereo audio on 3.5mm jack.
HDMI Input	F	HDMI 2.0 Input port. Capable of up to 4K60 with HDCP2.2 encryption.
LED Status	G	LED illuminated when unit has a video input
LED Power	H	LED illuminated when unit is powered



ZyPer4K XS Encoder (Fiber)



Port Name	Index	Definition
Power	A	12VDC from supply. Center Post is + Ring is -
10G Fiber	B	10 Gigabit Ethernet Connection. Uses standard 10Gb pluggable devices SFP devices.
Utility Network	C	10/100/1000Base-T Ethernet port. Used for general purpose device attachment to network. Traffic will be switched on to media network.
Mini USB-B	D	Mini USB 2.0 Type B port. Configuration and routing of USB handled by the ZMP configuration. (Only compatible with other XS/XSE/XR units)
Audio	E	Audio Input/Output Jack. Drives line-level stereo audio on 3.5mm jack.
HDMI Input	F	HDMI 2.0 Input port. Capable of up to 4K60 with HDCP2.2 encryption.
LED Status	G	LED illuminated when unit has a video input
LED Power	H	LED illuminated when unit is powered

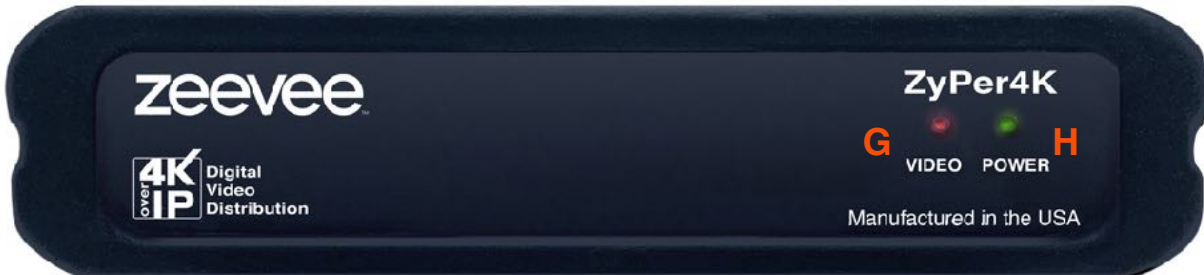

XSE Version Encoders

XSE version encoders provide a smaller footprint alternative as well as silent fanless operation. Note that XSE version encoders and standard encoders/decoders are compatible with each other with the exception of a few features noted below:

- XSE Version encoders do not support RS232 or IR ports.
- XSE Version encoders do not support Preview Streams
- XSE Version encoders do not support Multiview Text Overlay
- XSE Version units USB function is not compatible with standard unit USB units. (Except if Icron module installed)
- XSE Version unit USB does not support cameras. (Except if Icron module installed)



Note: Removing the rubber ring will void the warranty. The ring provides essential shock protection, unit spacing and is part of the seal that keeps foreign matter out of the unit.

ZyPer4K XSE Encoder (Copper)
Note: Dante/Icron is optional feature



Port Name	Index	Definition
Power	A	12VDC from supply. Center Post is + Ring is -
10G Copper (PoE)	B	10Gb Ethernet over Cat6a (or better) cabling. RJ45. Supports PoE. Important Note: If using PoE with ZyPer4K units; the ZyPer4K must have a path to the ground. This grounding can be accomplished by using a shielded network cable (F/UTP). Please see Appendix 3 of this manual for additional information.
Utility Network	C	10/100/1000Base-T Ethernet port. Used for general purpose device attachment to network. Traffic will be switched on to media network.
HDMI LoopOut	D	HDMI 2.0 Output (Loopout) Will output active video stream from either HDMI input or the USB-C input.
HDMI Input	E	HDMI 2.0 Input port. Capable of up to 4K60 with HDCP2.2 encryption.
USB-C Input	F	Combination USB-C (Display-Port Alt Mode) and USB Host port..
USB-C Charge Input	G	Input power port to provide output charging feature to USB-C Media Input port. Maximum 100W with appropriate USB-C cables for charge port and Media Input port. USB-C cables must have Emark chips to achieve 100W max.
Audio	H	Audio Input/Output Jack. Balanced 5-pin Phoenix.
LED Status	J	LED illuminated when unit has a video input
LED Power	K	LED illuminated when unit is powered



ZyPer4K XSE Encoder (Fiber)
Note: Dante/Icron is optional feature

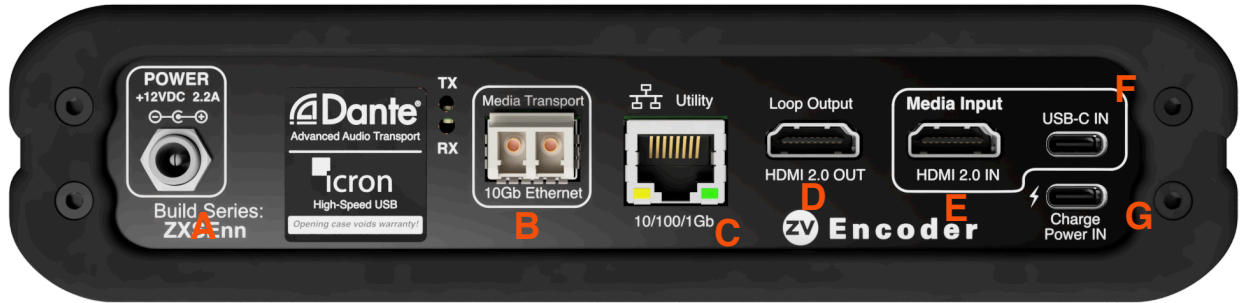

Port Name	Index	Definition
Power	A	12VDC from supply. Center Post is + Ring is -
10G Fiber	B	10 Gigabit Ethernet Connection. Uses standard 10Gb pluggable devices. SFP devices.
Utility Network	C	10/100/1000Base-T Ethernet port. Used for general purpose device attachment to network. Traffic will be switched on to media network.
HDMI LoopOut	D	HDMI 2.0 Output (Loopout) Will output active video stream from either HDMI input or the USB-C input.
HDMI Input	E	HDMI 2.0 Input port. Capable of up to 4K60 with HDCP2.2 encryption.
USB-C Input	F	Combination USB-C (Display-Port Alt Mode) and USB Host port..
USB-C Charge Input	G	Input power port to provide output charging feature to USB-C Media Input port. Maximum 100W with appropriate USB-C cables for charge port and Media Input port.
Audio	H	Audio Input/Output Jack. Balanced 5-pin Phoenix.
LED Status	J	LED illuminated when unit has a video input
LED Power	K	LED illuminated when unit is powered



Important Note (Optional Dante/Icron module for XSE encoder units)

The Optional Dante/Icron USB system requires its own IP Address that is different and independent from the IP Address of the ZyPer4K-XSE itself. Therefore a ZyPer4K-XSE unit with Dante and Icron USB needs three IP addresses. Customers that are using a DHCP server to generate IP Addresses must ensure the pool of available IP Addresses accounts these extra devices needing IP Addresses in the system.

If no DHCP server is available, the USB controller and Dante controller will assign themselves a Link-Local address. However, if there is a DHCP server, but there are not enough addresses available in the pool, USB connections and Dante may fail.

There is no means of setting the USB controller or Dante controller with a Static IP address.

Important Dante Note

The Dante feature can be enabled on either the 10G LAN or on an independent 1G LAN using the Utility Port.

There is an API command to configure the desired LAN for Dante operation.

set device <deviceMAC | deviceName> utilityPort enabled | disabled | onlyDanteAudio

Options:

1. enabled: Set's Dante to the 10G LAN. Utility port is technically the same LAN
2. disabled: Dante is completely disabled. Not available on either port
3. onlyDanteAudio: Dante is on Utility port as a separate LAN

ZyPer4K-XSE Encoder USB-C Charging Details

Does USB-C Cable have Emark chip?		Maximum Supported Power
Video Port	Power Port	
No	Yes	60 Watts
No	No	60 Watts
Yes	Yes	100 Watts
Yes	No	60 Watts

ZyPer4K-XS/XSE Encoder Reset Pin

The hardware reset pin for the ZyPer4K-XS/XSE encoder is located on the side of the unit with the regulatory markings. (Note image below enhanced to better show the location of the reset pin hole. There is no white circle around the reset pin hole.)



Port Name	Index	Definition
RESET	A	Reset to factory defaults. Disconnect power. Delete unit from ZMP GUI. Using a wire or paper clip, lightly press into this hole while powering on the unit. Hold for 15 seconds to reset the unit to factory defaults.

XR Version Encoders (discontinued)

XR version encoders provide a rugged enclosure with rugged connections options as well as silent fanless operation. Note that XR version encoders and standard encoders/decoders are compatible with each other with the exception of a few features noted below:

XR Version encoders do not support RS232 or IR ports.

XR Version encoders do not support Preview Streams

XR Version encoders do not support Multiview Text Overlay

XR Version units USB function is not compatible with standard unit USB units. (Is compatible with XS units)

XR Version unit USB does not support cameras.

Note: Removing the rubber ring will void the warranty. The ring provides essential shock protection, unit spacing and is part of the seal that keeps foreign matter out of the unit.

ZyPer4K XR Encoder (Copper)



Port Name	Index	Definition
10G Copper (PoE)	A	10Gb Ethernet over Cat6a (or better) cabling. RJ45. Supports PoE. Important Note: If using PoE with ZyPer4K units; the ZyPer4K must have a path to the ground. This grounding can be accomplished by using a shielded network cable (F/UTP). Please see Appendix 3 of this manual for additional information.
Utility Network	B	10/100/1000Base-T Ethernet port. (Neutrik NE8FDX-P6) Used for general purpose device attachment to network.
Audio	C	Audio Input/Output Jack. (Switchcraft D3F-XLR) Drives line-level stereo audio.
USB-B	D	USB 2.0 Type B port. (Switchcraft EHUSBBAX) Configuration and routing of USB handled by the ZMP configuration. (Only compatible with other XR and XS units)
HDMI Input	E	HDMI 2.0 Input port. (Switchcraft EHHDMI2)
Power	F	120/220V AC Power input. Requires Neutrik NAC3FX-W-TOP connector. Power cords do not ship with units. Example Power below: https://www.fullcompass.com/prod/517787-blizzard-true-main-1406-powercon-true1-compatible-to-edison-cable-14awg-6?gad_source=1&gclid=EAlaIqobChMlrlvqiNjbiAMVFTYIBR16UTWsEAQYASABEgKyiPD_BwE
LED Status	G	LED illuminated when unit has a video input
LED Power	H	LED illuminated when unit is powered



ZyPer4K XR Encoder (Fiber)



Port Name	Index	Definition
10G Fiber	A	10Gb Ethernet over Fiber. LC connector. (Neutrik N02-4FDW-1-A) Multimode or Single mode. SFP module integrated into the unit. (MMF Gasket = Black, SMF Gasket = Yellow) Note: MMF supports 50um fiber cable only
Utility Network	B	10/100/1000Base-T Ethernet port. (Neutrik NE8FDX-P6) Used for general purpose device attachment to network.
Audio	C	Audio Input/Output Jack. (Switchcraft D3F-XLR) Drives line-level stereo audio. Pin 1 = Audio Return, Pin 2 = Right Channel, Pin 3 = Left Channel
USB-B	D	USB 2.0 Type B port. (Switchcraft EHUSBAX) Configuration and routing of USB handled by the ZMP configuration. (Only compatible with other XR and XS units)
HDMI Input	E	HDMI 2.0 Input port. (Switchcraft EHHDMI2)
Power	F	120/220V AC Power input. Requires Neutrik NAC3FX-W-TOP connector. Power cords do not ship with units. Example Power below: https://www.fullcompass.com/prod/517787-blizzard-true-main-1406-powercon-true1-compatible-to-edison-cable-14awg-6?gad_source=1&gclid=EAlaIqobChMlrlvqiNjbiAMVFTYIBR16UTWsEAQYASABEgKyIPD_BwE
LED Status	G	LED illuminated when unit has a video input
LED Power	H	LED illuminated when unit is powered



ZyPer4K-XR Encoder Mounting Hole and Reset Pin

The hardware reset pin for the ZyPer4K-XR encoder is located on the side of the unit with the Stage-Clamp Mount Point. (Note image below enhanced to better show the location of the reset pin hole. There is no white dot to mark the reset pin hole.)

The ZyPer4K-XR encoder has a mounting hold for standard Truss Clamps. Thread is M10x1.5mm (course) with a maximum thread depth of 28mm.



Port Name	Index	Definition
RESET	A	Reset to factory defaults. Disconnect power. Delete unit from ZMP GUI. Using a wire or paper clip, lightly press into this hole while powering on the unit. Hold for 15 seconds to reset the unit to factory defaults.
Mount Hole	B	Stage-Clamp Mount Point. Thread M10x1.5mm (course). Max thread depth 28mm.

Important Notes about mounting:

When using a Stage/Truss clamp there is a requirement that the ZyPer4K-XR unit be “hung” from the bolt or “perched” on the bolt. The center of mass for the unit shall be directly above or directly downward from the bolt. Either upward or downward mounting is acceptable providing that the axis of the bolt shall be vertical.

If the axis of the bolt is not vertical, the side plate of the ZyPer-XR units can be torqued and stressed to the level that could cause permanent deformation or damage to the unit. Example accepted orientations are shown below:



Wallplate Encoder (US form factor-front)



Port Name	Index	Definition
Utility Network	A	10/100/1000Base-T Ethernet port. Used for general purpose device attachment to network.
Audio	B	Audio Input/Output Jack. Drives line-level stereo audio.
USB-B	C	USB 2.0 Type B port. Configuration and routing of USB handled by the ZMP configuration. (Compatible with ZyPer4K units if Icron included. Compatible with XS/XR units if Icron not included)
HDMI Input	D	HDMI 2.0 Input port.
USB-C Input	E	Full featured USB-C DisplayPort port (DP-Alt Mode) supporting both Video and USB Host functionality. Can support device charging only if 24V source connected to unit. Cannot charge if Z4K using PoE power only.
LED Status	F	LED illuminated when unit has a video input on HDMI or USB-C input
LED Power	G	LED illuminated when unit is powered
IR-OUT	H	Infrared commands information passed back FROM decoders as configured by ZMP. Note: Must use IR emitter shipped in box with unit.
IR-IN	J	Infrared commands to be passed TO decoders as configured by ZMP. Note: Must use IR receiver shipped in box with unit.
RS 232 Port	K	RS232 Control Port for sending and receiving side-band serial traffic to/from decoders as directed by ZyPer Management Platform (ZMP)
Video Select	L	Button to select between HDMI and USB-C video inputs when both are connected at same time

Port Name	Index	Definition
Reset	M	Reset to factory defaults. Disconnect power. Delete unit from ZMP GUI. Using a wire or paper clip, lightly press into this hole while powering on the unit. Hold for 15 seconds to reset the unit to factory defaults. (Note reset hole highlighted in drawing above. Hole is located under the cover plate)

Important USB-C information:

To ensure proper operation when using the USB-C input for video and/or USB-Host function and/or USB charging the USB-C cable must meet certain requirements.

USB-C Cable Requirements

1. Cable should be as short as possible
2. Must have USB-IF certification
3. Must be USB 3.2 Gen2 (2x1 or 2x2)
4. Current rating of 5A
5. Must support USB power delivery of 100W, 20V/5A
6. Data specs must be 20Gbp/s per lane (4K@60Hz) or above. (40Gbp/s cable)
7. USB Data specs must be 5Gbps (USB 3.0)
8. Must have built in E-Mark IC

Please see Appendix 1 near the end of this document for a list of known good USB-C cables.

ZeeVee is not responsible for damage to any equipment caused by poor or incorrect USB-C cables.

Wallplate Encoder (US form factor-back)

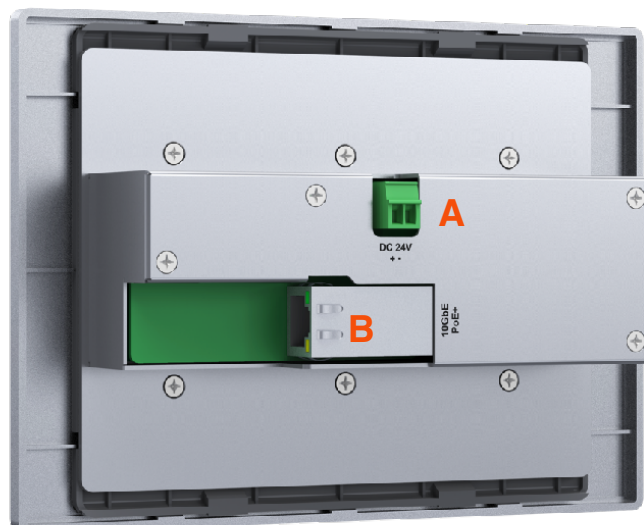

ZyPer4K

Port Name	Index	Definition
Power	A	24V DC Power. Phoenix connector. Note: Power supply does not ship with unit. Recommend to use PoE power.
10G Copper (PoE)	B	10Gb Ethernet over Cat6a (or better) cabling. RJ45. Supports PoE. Important Note: If using PoE with ZyPer4K units; the ZyPer4K must have a path to the ground. This grounding can be accomplished by using a shielded network cable (F/UTP). Please see Appendix 3 of this manual for additional information.

Note on PoE Power:

It is important to remember that the ZyPer4K wallplate is a device that requires a 10Gb network. Therefore any PoE injector must also support 10Gb data transfer.

ZeeVee recommends the following 10G PoE Injector for use with the ZyPer4K wallplate and ZyPer4K-XS copper units.

Procet PT-PSE104GB-60-10

To support PoE the following minimum Ethernet cable requirements must be met.

- Must be Cat6a 23AWG Solid Copper Twisted Pair.
- **Must be shielded**
- Maximum Length 328ft (100m)
- DC Loop Resistance per Pair < 25Ω
- DC Resistance Unbalance per Pair 3% or < 200mΩ

Important Notes

If using a Network Switch to provide PoE power to the ZyPer4K devices, it is important that the switch itself be protected against electrical surges that could be caused by something like a lightning strike. An appropriate surge protector should be placed between the Network Switch and AC power source.

Switching Inputs

The Video Select button can be used to manually change inputs. Otherwise input will act as follows:

Connected = Active source

- Both HDMI and USB-C disconnected – no link
- USBC disconnected, HDMI is connected – Wall Plate HDMI is connected
- HDMI disconnected; USB-C is connected – Wall Plate connects USB-C

ZyPer4K

Cable state changes

- HDMI connected; USB not connected but USB-C is then connected – Video remains HDMI
- USB-C is connected; HDMI is not connected but HDMI is then connected- Video changes to HDMI
- Any cable pulls at this point the video will fail over to the other active source.

Wallplate Encoder (EU form factor-front)



Port Name	Index	Definition
Utility Network	A	10/100/1000Base-T Ethernet port. Used for general purpose device attachment to network.
Audio	B	Audio Input/Output Jack. Drives line-level stereo audio.
USB-B	C	USB 2.0 Type B port. Configuration and routing of USB handled by the ZMP configuration. (Compatible with ZyPer4K units if Icron included. Compatible with XS/XR units if Icron not included)
HDMI Input	D	HDMI 2.0 Input port.
USB-C Input	E	Full featured USB-C DisplayPort port (DP-Alt Mode) supporting both Video and USB Host functionality. Can support device charging only if 24V source connected to unit. Cannot charge if Z4K using PoE power only.
LED Status	F	LED illuminated when unit has a video input on HDMI or USB-C input
LED Power	G	LED illuminated when unit is powered
IR-OUT	H	Infrared commands information passed back FROM decoders as configured by ZMP. Note: Must use IR emitter shipped in box with unit.
IR-IN	J	Infrared commands to be passed TO decoders as configured by ZMP. Note: Must use IR receiver shipped in box with unit.
RS 232 Port	K	RS232 Control Port for sending and receiving side-band serial traffic to/from decoders as directed by ZyPer Management Platform (ZMP)
Video Select	L	Button to select between HDMI and USB-C video inputs when both are connected at same time

Port Name	Index	Definition
Reset	M	Reset to factory defaults. Disconnect power. Delete unit from ZMP GUI. Using a wire or paper clip, lightly press into this hole while powering on the unit. Hold for 15 seconds to reset the unit to factory defaults. (Note reset hole highlighted in drawing above. Hole is not red)

Important USB-C information:

To ensure proper operation when using the USB-C input for video and/or USB-Host function and/or USB charging the USB-C cable must meet certain requirements.

USB-C Cable Requirements

1. Cable should be as short as possible
2. Must have USB-IF certification
3. Must be USB 3.2 Gen2 (2x1 or 2x2)
4. Current rating of 5A
5. Must support USB power delivery of 100W, 20V/5A
6. Data specs must be 20Gbp/s per lane (4K@60Hz) or above. (40Gbp/s cable)
7. USB Data specs must be 5Gbps (USB 3.0)
8. Must have built in E-Mark IC

Please see Appendix 1 near the end of this document for a list of known good USB-C cables.

ZeeVee is not responsible for damage to any equipment caused by poor or incorrect USB-C cables.



 Wallplate Encoder (EU form factor-back)

Port Name	Index	Definition
Power	A	24V DC Power. Phoenix connector. Note: Power supply does not ship with unit. Recommend to use PoE power.
10G Copper (PoE)	B	10Gb Ethernet over Cat6a (or better) cabling. RJ45. Supports PoE. Important Note: If using PoE with ZyPer4K units; the ZyPer4K must have a path to the ground. This grounding can be accomplished by using a shielded network cable (F/UTP). Please see Appendix 3 of this manual for additional information.

Note on PoE Power:

It is important to remember that the ZyPer4K wallplate is a device that requires a 10Gb network. Therefore any PoE injector must also support 10Gb data transfer.

ZeeVee recommends the following 10G PoE Injector for use with the ZyPer4K wallplate and ZyPer4K-XS copper units.

Procet PT-PSE104GB-60-10

To support PoE the following minimum Ethernet cable requirements must be met.

- Must be Cat6a 23AWG Solid Copper Twisted Pair.
- **Must be shielded**
- Maximum Length 328ft (100m)
- DC Loop Resistance per Pair < 25Ω
- DC Resistance Unbalance per Pair 3% or < 200mΩ

Important Note

If using a Network Switch to provide PoE power to the ZyPer4K devices, it is important that the switch itself be protected against electrical surges that could be caused by something like a lightning strike. An appropriate surge protector should be placed between the Network Switch and AC power source.

Switching Inputs

The Video Select button can be used to manually change inputs. Otherwise input will act as follows:

ZyPer4K

Connected = Active source

- Both HDMI and USB-C disconnected – no link
- USB-C disconnected, HDMI is connected – Wall Plate HDMI is connected
- HDMI disconnected; USB-C is connected – Wall Plate connects USB-C

Cable state changes

- HDMI connected; USB not connected but USB-C is then connected – Video remains HDMI
- USB-C is connected; HDMI is not connected but HDMI is then connected- Video changes to HDMI
- Any cable pulls at this point the video will fail over to the other active source.

Important USB-C information

To ensure proper operation when using the USB-C input for video and/or USB-Host function and/or USB charging the USB-C cable must meet certain requirements.

USB-C Cable Requirements

1. Cable should be as short as possible
2. Must have USB-IF certification
3. Must be USB 3.2 Gen2 (2x1 or 2x2)
4. Current rating of 5A
5. Must support USB power delivery of 100W, 20V/5A
6. Video Data specs must support 4K data at 60Hz (4K@60Hz 4:4:4)
7. Must have built in E-Mark IC

Please see Appendix 1 near the end of this document for a list of known good USB-C cables.

ZeeVee is not responsible for damage to any equipment caused by poor or incorrect USB-C cables.

Decoder

The function of the ZyPer4K Decoder is to accept a 10Gb IP feed containing the video information to be displayed. It decrypts, decodes and formats the video and audio information for display on the attached viewing device. The decoder is capable of outputting any HDMI 2.0 resolution supplied by the encoder including full 4K, 4:4:4 at 60Hz. There are several different variations based on the user's desired media type and USB options.

Enclosure variants

There are seven sizes of the ZyPer4K Decoder unit enclosure.

Output Function	Box Size
HDMI Output	Base unit: 175mm Wide x 43mm High x 144mm Deep
HDMI Output (Quiet/Fanless)	Base unit: 164mm Wide x 44mm High x 145mm Deep
HDMI and DisplayPort Output	Base unit: 175mm Wide x 43mm High x 144mm Deep
HDMI Output (XS Version)	199mm Wide x 47mm High x 116mm Deep
HDMI Output (XSE Version)	199mm Wide x 48mm High x 136mm Deep
HDMI Output (XR Version)	220mm Wide x 71mm High x 199mm Deep
US form factor wallplate	US 3-Gang size. 171.5mm Wide x 123.9mm High x 45.9mm Deep (Includes cover plate)
EU form factor wallplate	EU Size. 222.5mm Wide x 86mm High x 45.9mm Deep (Includes cover plate) (UK cover plate available at added cost)

Common Ports



The following ports are common to all decoders, regardless of the interface options.

ZyPer4K

Port Name	Index	Definition
Power	A	12VDC from supply at 1.2A (center +, ring-)
Utility Network	B	10/100/1000Base-T Ethernet port. Used for general purpose device attachment to network. Traffic will be switched on to media network.
Ground Lug	C	For equipotential referencing of the box, this lug may be connected the environmental ground using a customer-supplied ground lead.



Port Name	Index	Definition
HDMI Output	A	HDMI 2.0 Output port. Capable of up to 4K60 4:4:4 with embedded audio and HDCP2.2 encryption.



Port Name	Index	Definition
RS 232 Port	A	RS232 Control Port for sending and receiving side-band serial traffic to/from encoders as directed by ZyPer Management Platform. (ZMP)
LED PWR	B	LED illuminated when unit is powered
LED VID	C	LED Illuminated when active video is being processed
Audio	D	Audio Output Jack. Drives line-level stereo audio on 3.5mm jack.

ZyPer4K

Port Name	Index	Definition
IR-OUT	E	Infrared Commands information passed FROM Encoders to Decoders as configured by ZMP. Note: Must user ZeeVee part number Z4KIRTX
IR-IN	F	Infrared Commands to be passed TO Encoders as configured by ZMP. Note: Must user ZeeVee part number Z4KIRRX
RESET	G	Reset to factory defaults. Disconnect power. Delete unit from ZMP GUI. Using a wire or paper clip, lightly press into this hole while powering on the unit. Hold for 15 seconds to reset the unit to factory defaults.

Optional Ports: 10Gb Ethernet

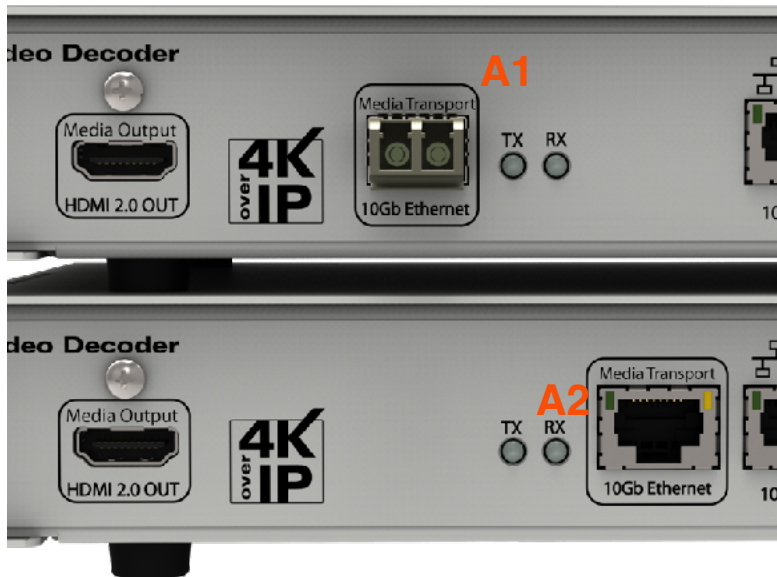

Port Name	Index	Definition
10G Fiber	A1	10 Gigabit Ethernet Connection. Uses standard 10Gb SFP devices.
10G Copper	A2	10Gb Ethernet over Cat6a or better cabling. RJ45

Optional Ports: USB



The ZyPer4K Decoder device can be ordered with optional USB connectivity.

Shown to the left is a unit with the USB option (top) and without the USB option (bottom) installed. This is a build-time option and is not retrofittable to the product.

Port Name	Index	Definition
USB	A	2 ports of USB 2.0 Type-A connectivity. Either port may be used and both operate simultaneously. Each port may provide up to 0.5A of power output (5V).

Important Note

The USB system requires its own IP Address that is different and independent from the IP Address of the ZyPer4K itself. Therefore a ZyPer4K unit with integrated USB needs two IP addresses. Customers that are using a DHCP server to generate IP Addresses must ensure the pool of available IP Addresses accounts these extra devices needing IP Addresses in the system.

If no DHCP server is available, the USB controller will assign itself a Link-Local address. However, if there is a DCHP server, but there are not enough addresses available in the pool, USB connections may fail.

There is no means of setting the USB controller with a Static IP address.

Optional Ports: Display Port



The ZyPer4K Decoder device can be ordered with an optional DisplayPort output.

Note: DisplayPort output port does not support any Audio capabilities.

Quiet/Fanless Decoder

The Quiet/Fanless decoder is available with either Copper or Fiber connectivity. Note that USB is not available with this version of hardware. (Note this product is discontinued)



Port Name	Index	Definition
HDMI Output	A	HDMI 2.0 Output port. Capable of up to 4K60 4:4:4 with embedded audio and HDCP2.2 encryption.
10Gb Ethernet	B	10Gb Ethernet over Cat6a or better cabling. RJ45
Utility Network	C	10/100/1000Base-T Ethernet port. Used for general purpose device attachment to network. Traffic will be switched on to media network.
Power	D	12VDC from supply at 1.2A (center +, ring-)



Port Name	Index	Definition
RS 232 Port	A	RS232 Control Port for sending and receiving side-band serial traffic to/from encoders as directed by ZyPer Management Platform. (ZMP)
LED PWR	B	LED illuminated when unit is powered
LED VID	C	LED Illuminated when active video is being processed
Audio	D	Audio Output Jack. Drives line-level stereo audio on 3.5mm jack.
IR-OUT	E	Infrared Commands information passed FROM Encoders to Decoders as configured by ZMP.
IR-IN	F	Infrared Commands to be passed TO Encoders as configured by ZMP.
RESET	G	Reset to factory defaults. Disconnect power. Delete unit from ZMP GUI. Using a wire or paper clip, lightly press into this hole while powering on the unit. Hold for 15 seconds to reset the unit to factory defaults.

Note: The preferred orientation of the fanless decoder is vertical with at least 1.5 inches of clearance around all sides.

XS Version Decoders

XS version decoders provide a smaller footprint alternative as well as silent fanless operation. Note that XS version decoders and standard encoders/decoders are compatible with each other with the exception of a few features noted below:

- XS Version decoders do not support IR ports.
- XS Version decoders do not support RS232 ports.
- XS Version decoders do not support Preview Streams
- XS Version decoders do not support Multiview Text Overlay
- XS Version units USB function is not compatible with standard unit USB units.
- XS Version unit USB does not support cameras.

Note: Removing the rubber ring will void the warranty. The ring provides essential shock protection, unit spacing and is part of the seal that keeps foreign matter out of the unit.

ZyPer4K-XS Decoder (Copper)



Port Name	Index	Definition
Power	A	12VDC from supply. Center Post is + Ring is -
10G Copper (PoE)	B	10Gb Ethernet over Cat6a (or better) cabling. RJ45. Supports PoE. Important Note: If using PoE with ZyPer4K units; the ZyPer4K must have a path to the ground. This grounding can be accomplished by using a shielded network cable (F/UTP) or the connected HDMI display is grounded. (i.e. A 3-prong power connector on display) Please see Appendix 3 of this manual for additional information.
Utility Network	C	10/100/1000Base-T Ethernet port. Used for general purpose device attachment to network. Traffic will be switched on to media network.
USB-A	D	USB 2.0 Type A port. Configuration and routing of USB handled by the ZMP configuration. (Only compatible with other XS/XR units) Provides up to 0.5A of power (5V)
Audio	E	Audio Output Jack. Drives line-level stereo audio on 3.5mm jack.
HDMI Output	F	HDMI 2.0 Output port. Capable of up to 4K60 with HDCP2.2 encryption.
LED Status	G	LED illuminated when unit has a video input
LED Power	H	LED illuminated when unit is powered



ZyPer4K-XS Decoder (Fiber)



Port Name	Index	Definition
Power	A	12VDC from supply. Center Post is + Ring is -
10G Fiber	B	10 Gigabit Ethernet Connection. Uses standard 10Gb pluggable devices SFP devices.
Utility Network	C	10/100/1000Base-T Ethernet port. Used for general purpose device attachment to network. Traffic will be switched on to media network.
USB-A	D	USB 2.0 Type A port. Configuration and routing of USB handled by the ZMP configuration. (Only compatible with other XS/XR units) Provides up to 0.5A of power (5V)
Audio	E	Audio Output Jack. Drives line-level stereo audio on 3.5mm jack.
HDMI Output	F	HDMI 2.0 Output port. Capable of up to 4K60 with HDCP2.2 encryption.
LED Status	G	LED illuminated when unit has a video input
LED Power	H	LED illuminated when unit is powered



XSE Version Decoders

XSE version decoders provide a smaller footprint alternative as well as silent fanless operation. Note that XSE version decoders and standard encoders/decoders are compatible with each other with the exception of a few features noted below:

XSE Version decoders do not support IR ports.

XSE Version decoders do not support Preview Streams

XSE Version decoders do not support Multiview Text Overlay

XSE Version units USB function is not compatible with standard unit USB units. (Except if Icron module installed)

XSE Version unit USB does not support cameras.(Except if Icron module installed)

Note: Removing the rubber ring will void the warranty. The ring provides essential shock protection, unit spacing and is part of the seal that keeps foreign matter out of the unit.

ZyPer4K-XSE Decoder Rev 1 (Copper)
Note: Dante/Icron is Optional Feature



Port Name	Index	Definition
Power	A	12VDC from supply. Center Post is + Ring is -
10G Copper (PoE)	B	10Gb Ethernet over Cat6a (or better) cabling. RJ45. Supports PoE. Important Note: If using PoE with ZyPer4K units; the ZyPer4K must have a path to the ground. This grounding can be accomplished by using a shielded network cable (F/UTP) or the connected HDMI display is grounded. (i.e. A 3-prong power connector on display) Please see Appendix 3 of this manual for additional information.
Utility Network	C	10/100/1000Base-T Ethernet port. Used for general purpose device attachment to network. Traffic will be switched on to media network.
USB-A	D	USB 2.0 Type A port. Configuration and routing of USB handled by the ZMP configuration. Provides up to 0.5A of power (5V). Note: Rev2 of this unit will have 2 USB-A ports.
RS-232	E	RS232 Control Port for sending and receiving side-band serial traffic to/from decoders as directed by ZyPer Management Platform.
HDMI Output	F	HDMI 2.0 Output port. Capable of up to 4K60 with HDCP2.2 encryption.
Audio Output	G	Balanced Audio Output. 5-pin Phoenix.
LED Status	H	LED illuminated when unit has a video input
LED Power	J	LED illuminated when unit is powered



ZyPer4K-XSE Decoder Rev 1 (Fiber)
Note: Dante/Icron is Optional Feature

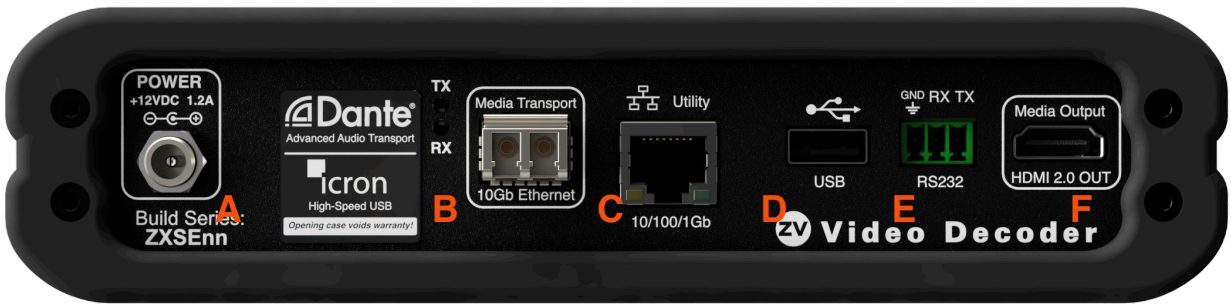

Port Name	Index	Definition
Power	A	12VDC from supply. Center Post is + Ring is -
10G Fiber	B	10 Gigabit Ethernet Connection. Uses standard 10Gb pluggable devices SFP devices.
Utility Network	C	10/100/1000Base-T Ethernet port. Used for general purpose device attachment to network. Traffic will be switched on to media network.
USB-A	D	USB 2.0 Type A port. Configuration and routing of USB handled by the ZMP configuration. Provides up to 0.5A of power (5V). Note: Rev2 of this unit will have 2 USB-A ports.
RS-232	E	RS232 Control Port for sending and receiving side-band serial traffic to/from decoders as directed by ZyPer Management Platform.
HDMI Output	F	HDMI 2.0 Output port. Capable of up to 4K60 with HDCP2.2 encryption.
Audio Output	G	Balanced Audio Output. 5-pin Phoenix.
LED Status	H	LED illuminated when unit has a video input
LED Power	J	LED illuminated when unit is powered



Important Note (Optional Dante/Icron module for XSE decoder units)

The Optional Dante/Icron USB system requires its own IP Address that is different and independent from the IP Address of the ZyPer4K-XSE itself. Therefore a ZyPer4K-XSE unit with Dante and Icron USB needs three IP addresses. Customers that are using a DHCP server to generate IP Addresses must ensure the pool of available IP Addresses accounts for these extra devices needing IP Addresses in the system.

If no DHCP server is available, the USB controller and Dante controller will assign themselves a Link-Local address. However, if there is a DHCP server, but there are not enough addresses available in the pool, USB connections and Dante may fail.

There is no means of setting the USB controller or Dante controller with a Static IP address.

Important Interoperability Note

When the ZyPer4K Encoder is a “white box” or “Wall plate”; the Icron enabled XSE decoder (Rev 1) USB feature will only work with USB 2.0 devices connected to it. Decoder will not function with USB 1.0 or USB 1.1 devices. Devices such as keyboards and mice.

Workaround: Connect an external USB HUB to the ZyPer4K-XSE Decoder. This will allow any USB 1.0, 1.1 or 2.0 device to function properly. ZeeVee will add an internal USB hub in an upcoming revision of the ZyPer4K-XS hardware. (Note this updated unit will be identified easily as it will have 2 USB-A ports)

Note: Connection of external USB HUB should only be done while the ZyPer4K unit is powered off. Do not hot plug USB HUB into ZyPer4K.

Important Dante Note

The Dante feature can be enabled on either the 10G LAN or on an independent 1G LAN using the Utility Port.

There is an API command to configure the desired LAN for Dante operation.

```
set device <deviceMAC | deviceName> utilityPort enabled | disabled | onlyDanteAudio
```

Options:

1. enabled: Set's Dante to the 10G LAN. Utility port is technically the same LAN
2. disabled: Dante is completely disabled. Not available on either port
3. onlyDanteAudio: Dante is on Utility port as a separate LAN

ZyPer4K-XS/XSE Decoder Reset Pin

The hardware reset pin for the ZyPer4K-XS/XSE decoder is located on the side of the unit with the regulatory markings. (Note image below enhanced to better show the location of the reset pin hole. There is no white circle around the reset pin hole.)



Port Name	Index	Definition
RESET	A	Reset to factory defaults. Disconnect power. Delete unit from ZMP GUI. Using a wire or paper clip, lightly press into this hole while powering on the unit. Hold for 15 seconds to reset the unit to factory defaults.

XR Version Decoders (discontinued)

XR version decoders provide a rugged enclosure with rugged connections options as well as silent fanless operation. Note that XR version decoders and standard encoders/decoders are compatible with each other with the exception of a few features noted below:

XR Version decoders do not support RS232 or IR ports.

XR Version decoders do not support Preview Streams

XR Version decoders do not support Multiview Text Overlay

XR Version units USB function is not compatible with standard unit USB units. (Is compatible with XS units)

XR Version unit USB does not support cameras.

Note: Removing the rubber ring will void the warranty. The ring provides essential shock protection, unit spacing and is part of the seal that keeps foreign matter out of the unit.

ZyPer4K XR Decoder (Copper)



Port Name	Index	Definition
10G Copper (PoE)	A	10Gb Ethernet over Cat6a (or better) cabling. RJ45. Supports PoE. Important Note: If using PoE with ZyPer4K units; the ZyPer4K must have a path to the ground. Please see Appendix 3 for additional information.
Utility Network	B	10/100/1000Base-T Ethernet port. (Neutrik NE8FDX-P6) Used for general purpose device attachment to network.
Audio	C	Audio Output Jack. (Switchcraft D3F-XLR) Drives line-level stereo audio. Pin 1 = Audio Return, Pin 2 = Right Channel, Pin 3 = Left Channel
USB-A	D	USB 2.0 Type A port. (Switchcraft EHUSBABX) Configuration and routing of USB handled by the ZMP. (Only compatible with other XR and XS units)
HDMI Output	E	HDMI 2.0 Output port. (Switchcraft EHHDMI2)
Power	F	120/220V AC Power input. Requires Neutrik NAC3FX-W-TOP connector. Power cords do not ship with units. Example Cable below: https://www.fullcompass.com/prod/517787-blizzard-true-main-1406-powercon-true1-compatible-to-edison-cable-14awg-6?gad_source=1&gclid=EAlaIqobChMlrlvqiNjbiAMVFTYIBR16UTWsEAQYASABEgKyiPD_BwE
LED Status	G	LED illuminated when unit outputting video
LED Power	H	LED illuminated when unit is powered



ZyPer4K XR Decoder (Fiber)

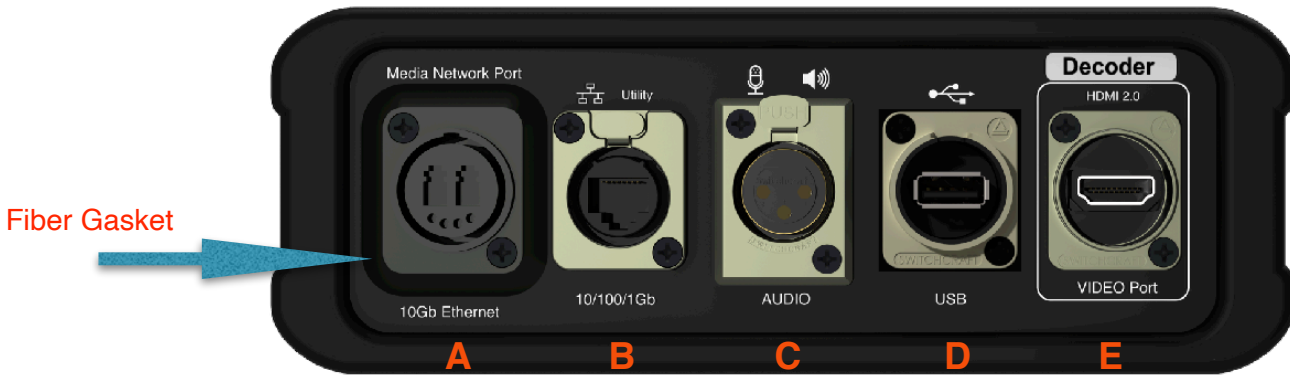

Port Name	Index	Definition
10G Fiber	A	10Gb Ethernet over Fiber. LC connector. (Neutrik N02-4FDW-1-A) Multimode or Single mode SFP module integrated into the unit. (MMF Gasket = Black, SMF Gasket = Yellow) Note: MMF supports 50um fiber cable only
Utility Network	B	10/100/1000Base-T Ethernet port. (Neutrik NE8FDX-P6) Used for general purpose device attachment to network.
Audio	C	Audio Input/Output Jack. (Switchcraft D3F-XLR) Drives line-level stereo audio.
USB-A	D	USB 2.0 Type A port. (Switchcraft EHUSBABX) Configuration and routing of USB handled by the ZMP configuration. (Only compatible with other XR and XS units) Provides up to 0.5A of power (5V)
HDMI Output	E	HDMI 2.0 Output port. (Switchcraft EHHDMI2)
Power	F	120/220V AC Power input. Requires Neutrik NAC3FX-W-TOP connector. Power cords do not ship with units. Example power cord link below: https://www.fullcompass.com/prod/517787-blizzard-true-main-1406-powercon-true1-compatible-to-edison-cable-14awg-6?gad_source=1&gclid=EAlaIqobChMlrlvqiNjbiAMVFTYIBR16UTWsEAQYASABEgKyIPD_BwE
LED Status	G	LED illuminated when unit is outputting video
LED Power	H	LED illuminated when unit is powered



ZyPer4K-XR Decoder Mounting Hole and Reset Pin

The hardware reset pin for the ZyPer4K-XR decoder is located on the side of the unit with the Stage-Clamp Mount Point. (Note image below enhanced to better show the location of the reset pin hole. There is no white dot to mark the reset pin hole.)

The ZyPer4K-XR encoder has a mounting hold for standard Truss Clamps. Thread is M10x1.5mm (course) with a maximum thread depth of 28mm.



Port Name	Index	Definition
RESET	A	Reset to factory defaults. Disconnect power. Delete unit from ZMP GUI. Using a wire or paper clip, lightly press into this hole while powering on the unit. Hold for 15 seconds to reset the unit to factory defaults.
Mount Hole	B	Stage-Clamp Mount Point. Thread M10x1.5mm (course). Max thread depth 28mm.

Important Notes about mounting:

When using a Stage/Truss clamp there is a requirement that the ZyPer4K-XR unit be “hung” from the bolt or “perched” on the bolt. The center of mass for the unit shall be directly downward from the bolt.

If the axis of the bolt is not vertical, the side plate of the ZyPer-XR units can be torqued and stressed to the level that could cause permanent deformation or damage to the unit. Example accepted orientation is shown below:

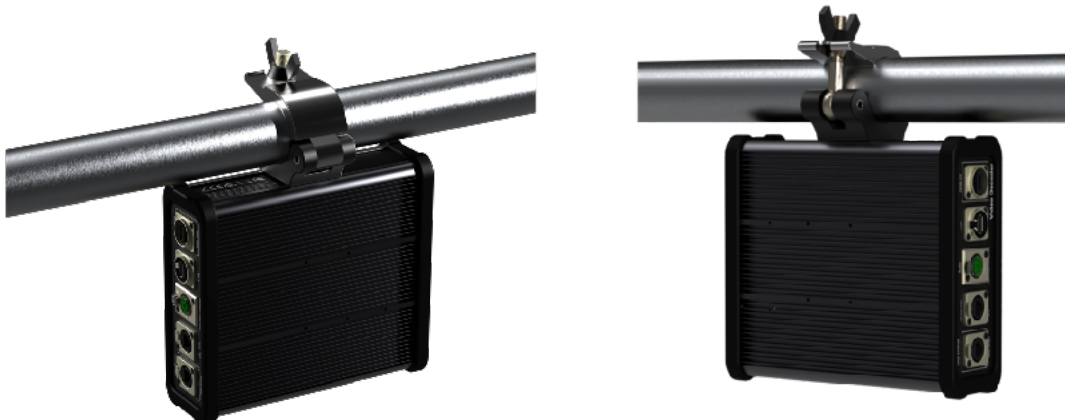

Wallplate Decoder (US form factor-front)



Port Name	Index	Definition
Utility Network	A	10/100/1000Base-T Ethernet port. Used for general purpose device attachment to network.
Audio	B	Audio Output Jack. Drives line-level stereo audio.
USB-A	C	USB 2.0 Type A ports. Configuration and routing of USB handled by the ZMP configuration. (Compatible with ZyPer4K units if Icron included. Compatible with XS/XR units if Icron not included) Each port provides up to 0.5A of power (5V)
HDMI Output	D	HDMI 2.0 Output port.
LED Status	E	LED illuminated when unit is outputting video.
LED Power	F	LED illuminated when unit is powered
IR-OUT	G	Infrared Commands information passed back FROM decoders as configured by ZMP. Note: Must use IR emitter shipped in box with unit.
IR-IN	H	Infrared Commands to be passed TO decoders as configured by ZMP. Note: Must use IR receiver shipped in box with unit.
RS 232 Port	J	RS232 Control Port for sending and receiving side-band serial traffic to/from decoders as directed by ZyPer Management Platform (ZMP)

Port Name	Index	Definition
Reset	K	Reset to factory defaults. Disconnect power. Delete unit from ZMP GUI. Using a wire or paper clip, lightly press into this hole while powering on the unit. Hold for 15 seconds to reset the unit to factory defaults. (Note reset hole highlighted in drawing above. Hole is located under the cover plate)

Wallplate Decoder (US form factor-back)

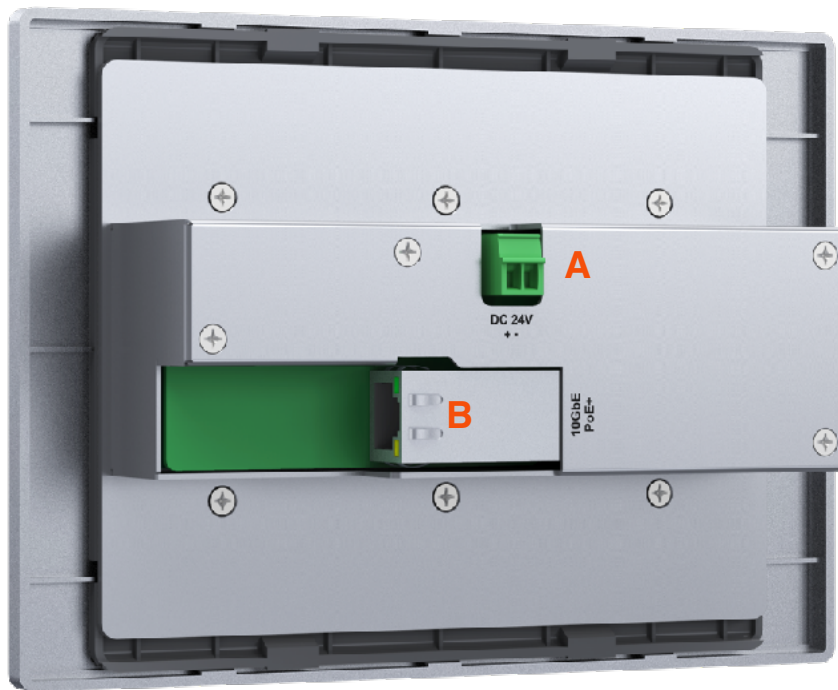

Port Name	Index	Definition
Power	A	24V DC Power. Phoenix connector. Note: Power supply does not ship with unit. Recommend to use PoE power.
10G Copper (PoE)	B	10Gb Ethernet over Cat6a (or better) cabling. RJ45. Supports PoE. Important Note: If using PoE with ZyPer4K units; the ZyPer4K must have a path to the ground. This grounding can be accomplished by using a shielded network cable (F/UTP) or the connected HDMI display is grounded. (i.e. A 3-prong power connector on display) Please see Appendix 3 of this manual for additional information.

Note on PoE Power:

It is important to remember that the ZyPer4K wallplate is a device that requires a 10Gb network. Therefore any PoE injector must also support 10Gb data transfer.

ZyPer4K

ZeeVee recommends the following 10G PoE Injector for use with the ZyPer4K wallplate and ZyPer4K-XS copper units.

Procet PT-PSE104GB-60-10

To support PoE the following minimum Ethernet cable requirements must be met.

- Must be Cat6a 23AWG Solid Copper Twisted Pair.
- **Must be shielded**
- Maximum Length 328ft (100m)
- DC Loop Resistance per Pair $< 25\Omega$
- DC Resistance Unbalance per Pair 3% or $< 200m\Omega$

Important Note

If using a Network Switch to provide PoE power to the ZyPer4K devices, it is important that the switch itself be protected against electrical surges that could be caused by something like a lightning strike. An appropriate surge protector should be placed between the Network Switch and AC power source.

Wallplate Decoder (EU form factor-front)



Port Name	Index	Definition
Utility Network	A	10/100/1000Base-T Ethernet port. Used for general purpose device attachment to network.
Audio	B	Audio Output Jack. Drives line-level stereo audio.
USB-A	C	USB 2.0 Type A ports. Configuration and routing of USB handled by the ZMP configuration. (Compatible with ZyPer4K units if Icron included. Compatible with XS/XR units if Icron not included) Each port provides up to 0.5A of power (5V)
HDMI Output	D	HDMI 2.0 Output port.
LED Status	E	LED illuminated when unit is outputting video
LED Power	F	LED illuminated when unit is powered
IR-OUT	G	Infrared Commands information passed back FROM decoders as configured by ZMP. Note: Must use IR emitter shipped in box with unit.
IR-IN	H	Infrared Commands to be passed TO decoders as configured by ZMP. Note: Must use IR receiver shipped in box with unit.
RS 232 Port	J	RS232 Control Port for sending and receiving side-band serial traffic to/from decoders as directed by ZyPer Management Platform (ZMP)
Reset	K	Reset to factory defaults. Disconnect power. Delete unit from ZMP GUI. Using a wire or paper clip, lightly press into this hole while powering on the unit. Hold for 15 seconds to reset the unit to factory defaults. (Note reset hole highlighted in drawing above. Hole is not red)

Wallplate Decoder (EU form factor-back)



Port Name	Index	Definition
Power	A	24V DC Power. Phoenix connector. Note: Power supply does not ship with unit. Recommend to use PoE power.
10G Copper (PoE)	B	10Gb Ethernet over Cat6a (or better) cabling. RJ45. Supports PoE. Important Note: If using PoE with ZyPer4K units; the ZyPer4K must have a path to the ground. This grounding can be accomplished by using a shielded network cable (F/UTP) or the connected HDMI display is grounded. (i.e. A 3-prong power connector on display) Please see Appendix 3 of this manual for additional information.

Note on PoE Power:

It is important to remember that the ZyPer4K wallplate is a device that requires a 10Gb network. Therefore any PoE injector must also support 10Gb data transfer.

ZeeVee recommends the following 10G PoE Injector for use with the ZyPer4K wallplate and ZyPer4K-XS copper units.

Procet PT-PSE104GB-60-10

To support PoE the following minimum Ethernet cable requirements must be met.

- Must be Cat6a 23AWG Solid Copper Twisted Pair.
- **Must be shielded**
- Maximum Length 328ft (100m)
- DC Loop Resistance per Pair < 25Ω

ZyPer4K

- DC Resistance Unbalance per Pair 3% or $< 200\text{m}\Omega$

Important Note

If using a Network Switch to provide PoE power to the ZyPer4K devices, it is important that the switch itself be protected against electrical surges that could be caused by something like a lightning strike. An appropriate surge protector should be placed between the Network Switch and AC power source.

Options

Most ZyPer4K Encoders or Decoders can be ordered with a single 10G bulk media port that is either Fiber Ethernet or Copper Ethernet. Only one of those options is supported at a given time. (Wallplate units available as Copper only)

Type	Encoder	Decoder	Parameter
Fiber Ethernet	✓	✓	Single 10GBASE-F-xx receptacle supporting installation of: Duplex fiber cable, SFP+ module (1 LC connector) <i>SFP+ module sold separately.</i>
Copper Ethernet	✓	✓	Single 10GBASE-T RJ45 connector

**only one of the above may be installed at a given time

Other Ports

Type	Standard Encoder	Standard Decoder	XS/XR Encoder	XS/XR Decoder	Parameter
Utility Ethernet	✓	✓	✓	✓	Single 1GBASE-T- RJ45 receptacle for general purpose connectivity at Encoder or Decoder side. Traffic is switched onto same logical segment as the bulk media traffic. <i>Recommend connection to a terminal leaf.</i>
RS232	✓	✓		*	Connector: 1-DB9 Standard 9-pin Female DCE connector. Communication: up to 115.2K baud Note: XSE Decoder unit supports RS232. Connector is 3-pin phoenix.
USB-A (2)		✓			[optional] 2 x Standard USB 2.0 Type-A port (Not available on Quiet/Fanless)
USA-A (1)				✓	1 x Standard USB 2.0 Type-A port. Only compatible with other XS/XR units.
USB-B	✓				[optional] 1x Standard USB2.0 Type-B port
Mini USB-B or USB-C			✓*		1 x Mini USB 2.0 Type-B port. Only compatible with other XS/XR units. Note: XSE Encoder supports a single USB-C connector. Unit may have configurable Icron unit installed.

ZyPer4K

Type	Standard Encoder	Standard Decoder	XS/XR Encoder	XS/XR Decoder	Parameter
Analog Audio	✓		✓*		3.5mm L/R analog audio jack 2-channel L/R line level stereo input — or ZMP configured as — 2-channel L/R stereo output (down-mixed from HDMI port of encoder) Note: XSE units support 5-pin phoenix connector
Analog Audio		✓		✓*	3.5mm L/R analog audio jack 2-channel L/R stereo output Note: Updated XS units support 5-pin phoenix connector
IR Input	✓	✓			3.5mm plug for IR Capture Dongle (ZeeVee Model#: Z4KIRRX) ** capture dongle sold separately
IR Output	✓	✓			3.5mm plug for IR Transmitter (ZeeVee Model#: Z4KIRTX) ** transmit dongle sold separately

Analog Audio Jack supports a 3.5mm PC-audio type plug with the pinout as shown to the right:

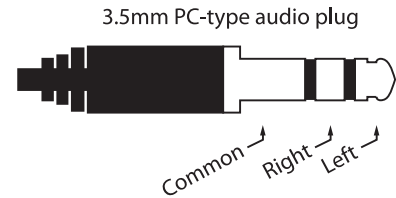

Setting Up ZyPer4K in a Point to Point Environment

A point to point, or one to one environment involves connecting one source directly to one display. A network switch is not needed in this basic configuration. This environment also does not require configuration through the ZyPer4K management software and is a true “plug and play” setup.

If using analog audio, RS232 or Infrared, you may need to configure the Encoder and Decoder with our management software. See the ZyPer4K Management Platform User Manual for more information.

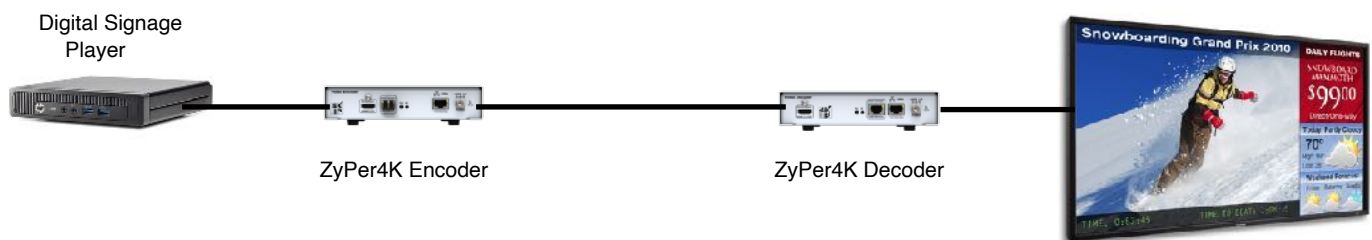

1. Connect HDMI cable from active source to Encoder (HDMI In port). Ensure Encoder is plugged in and pwr LED light illuminated. When HDMI cable is connected, the video (vid) light will illuminate.
2. Connect Ethernet cable either using SFP+ module (Fiber) or RJ45 jack (Copper) between Encoder and Decoder. (Both Encoder and Decoder must be same configuration. Fiber or Copper in this configuration)
3. Connect HDMI cable from active display to Decoder (HDMI Out port). Ensure Decoder is plugged in and that pwr light is illuminated.

Dante Embedded Platform (DEP)



Some ZyPer4K Encoders and Decoders support DEP. This means every endpoint can be configured to support both Dante transmission and receive functionality.

Feature		Supported/Description
Dante Audio channels		2x2 (input x output)
Sample rate		44.1, 48, 88.2, 96 kHz
Audio format		LPCM only
PCM sample format		Signed 32-bit little endian
Z4K Encoder	Dante transmitter	HDMI-in or local analogue audio input
	Dante receiver	To Z4K audio network
Z4K Decoder	Dante transmitter	From Z4K audio network
	Dante receiver	HDMI-out and local analogue audio output.

Important Note

Dante Embedded Platform can be implemented to operation on either LAN port ZyPer4K units. In a single LAN configuration, the Dante function and standard Z4K AV function share the same LAN. Dante AV-A requires its own IP Address that is different and independent from the IP Address of the ZyPer4K itself. This IP address cannot be changed in Dante Controller.

Important Note: The Utility port must be enabled for Dante to operate even if the Utility port is not being used for Dante transfers. (10G port being used) Customers that are using a DHCP server to generate IP Addresses must ensure the pool of available IP Addresses accounts for any ZyPer4K endpoints with Dante Embedded in the system.

For a Dual LAN configuration, Dante Embedded Platform requires its own IP Address that is different and independent from the IP Address of the ZyPer4K itself. This could include the DEP IP address being on a different subnet. Customers that are using a DHCP server to generate IP Addresses must ensure the pool of available IP Addresses accounts for any ZyPer4K endpoints with Dante Embedded Platform in the system.

If no DHCP server is available, DEP will assign itself a Link-Local address. However, if there is a DHCP server, but there are not enough addresses available in the pool, Dante connections may fail.

ZyPer4K

Critical Note:

For Dual LAN configuration. The Dante LAN port and Primary Z4K 10G LAN port should never be on the same subnet. This will cause IP conflicts that could result in video not properly flowing on the network. (Note this means that you cannot have both ports set to a Link-Local address. You must manually configure one of the two ports to a different subnet)

Dante on primary 10G LAN (This is the same LAN)

The screenshot shows the ZyPer Management Platform interface. The 'Network' tab is selected. A table lists network configurations for various devices. The 'Dec-XSE' device has its 'Utility Port' set to 'enabled', which is highlighted in green. Below the table are 'Reset' and 'Apply' buttons.

Name	MAC Address	IP Mode	IP Addr	IP Mask	IP Gateway	USB IP Addr	Utility Port
Z4K-XS-Dec	00:16:c0:4d:e3:12	dhcp	192.168.0.12	255.255.255.0	192.168.0.1	none	disabled
UHD60-1D	00:1c:d5:01:09:65	dhcp	192.168.0.31	255.255.255.0	192.168.0.1	none	NA
Dec-XSE	00:1c:d5:0c:01:c3	dhcp	192.168.0.25	255.255.255.0	192.168.0.1	192.168.0.27	enabled
UHD60-1DA	34:1b:22:81:f9:88	dhcp	192.168.0.32	255.255.255.0	192.168.0.1	none	NA
XSE-Dec-Combo	6c:df:fb:00:03:a0	dhcp	192.168.0.32	255.255.255.0	192.168.0.1	none	enabled
XSE_Dec_Built	6c:df:fb:00:03:c2	dhcp	192.168.0.5	255.255.255.0	192.168.0.1	none	disabled
Z4K-Dec2	d8:80:39:59:f0:3e	dhcp	192.168.0.28	255.255.255.0	192.168.0.1	192.168.0.25	disabled

Dante on Utility Port (1G LAN) This is a different LAN

The screenshot shows the ZyPer Management Platform interface. The 'Network' tab is selected. A table lists network configurations for various devices. The 'Dec-XSE' device has its 'Utility Port' set to 'onlyDanteAudio', which is highlighted in green. Below the table are 'Reset' and 'Apply' buttons.

Name	MAC Address	IP Mode	IP Addr	IP Mask	IP Gateway	USB IP Addr	Utility Port
Z4K-XS-Dec	00:16:c0:4d:e3:12	dhcp	192.168.0.12	255.255.255.0	192.168.0.1	none	disabled
UHD60-1D	00:1c:d5:01:09:65	dhcp	192.168.0.31	255.255.255.0	192.168.0.1	none	NA
Dec-XSE	00:1c:d5:0c:01:c3	dhcp	192.168.0.25	255.255.255.0	192.168.0.1	192.168.0.27	onlyDanteAudio
UHD60-1DA	34:1b:22:81:f9:88	dhcp	192.168.0.32	255.255.255.0	192.168.0.1	none	NA
XSE-Dec-Combo	6c:df:fb:00:03:a0	dhcp	192.168.0.32	255.255.255.0	192.168.0.1	none	enabled
XSE_Dec_Built	6c:df:fb:00:03:c2	dhcp	192.168.0.5	255.255.255.0	192.168.0.1	none	disabled
Z4K-Dec2	d8:80:39:59:f0:3e	dhcp	192.168.0.28	255.255.255.0	192.168.0.1	192.168.0.25	disabled



Dante Operation

It is expected that the user is familiar with Dante and the use of Dante networks. It is beyond the scope of this document to provide Dante training.

The Dante Transmitter found in the ZyPer4K encoder/decoder will insert the *analog audio* or *HDMI audio* stream that it is receiving onto the Dante Network. Note that the audio must be unencoded/unencrypted. Only raw PCM audio can be inserted onto the Dante network. It is possible the AV video network and the Dante audio network are in fact the same network. It is not possible to route Dante audio traffic from one VLAN onto another VLAN.

By default if only HDMI audio is available, this audio stream will be inserted onto the Dante network. If Analog audio is available via the Analog audio input port; then this audio stream will be inserted onto the Dante network instead of any available HDMI audio.

Network settings are the same as standard ZyPer4K encoders/decoders. Some switches may require additional settings to work with a Dante network. For example the Netgear M4300 series requires settings detailed at the following location:

<https://kb.netgear.com/000060205/M4300-Configuration-Guide-for-Dante-Audio-Devices>

The user should consult the documentation for the switch provider being used.

In Dante Controller the device will appear as a Transmitter and Receiver with the name DEP-
YYYYYY

YYYYYY - Represents the final bytes of the Dante Controllers MAC Address

Note that the device can be renamed in Dante Controller software. A factory reset of the ZyPer4K will restore the default Dante name.

Important Note: ZyPer4K Dante devices should never be made the Dante Clock Leader. Please select another Dante device as the Clock Leader (Preferred Leader)

Below are screen shots from *Dante Controller*.

Dante Status

The screenshot shows the Dante Controller interface for a device named 'Proto-XSE-Encoder-DEP-0c01f6'. The interface includes a menu bar (File, Devices, View, Help), a toolbar with various icons, and a main content area with several tabs: Receive, Transmit, Status (selected), Latency, Device Config, Network Config, and AES67 Config. The main content area is divided into four sections:

- Manufacturer Information:**
 - Manufacturer: Zeevee Pty Ltd
 - Model Name: DEP
 - Product Version: 1.0.1
- Dante Information:**
 - Dante Model: Dante Embedded Platform
 - Dante Software Version: 1.3.1.1
- Clock Synchronization:**
 - Mute Status: Unmuted
 - Sync Status: Locked
 - External Word Clock: No
 - Preferred: No
 - Frequency Offset: -25 ppm
- Interfaces:**
 - IP Address: 192.168.0.24
 - MAC Address: 00:1C:D5:0C:01:F6
 - Tx Utilization: 3 Mbps
 - Rx Utilization: 23 Kbps
 - Errors: 0
 - A 'Clear Counters' button is present.
 - A network icon shows a '100' Mbps speed and a green status indicator.

Important Note: The **Sample Rate** must be set to the correct rate of the incoming audio.

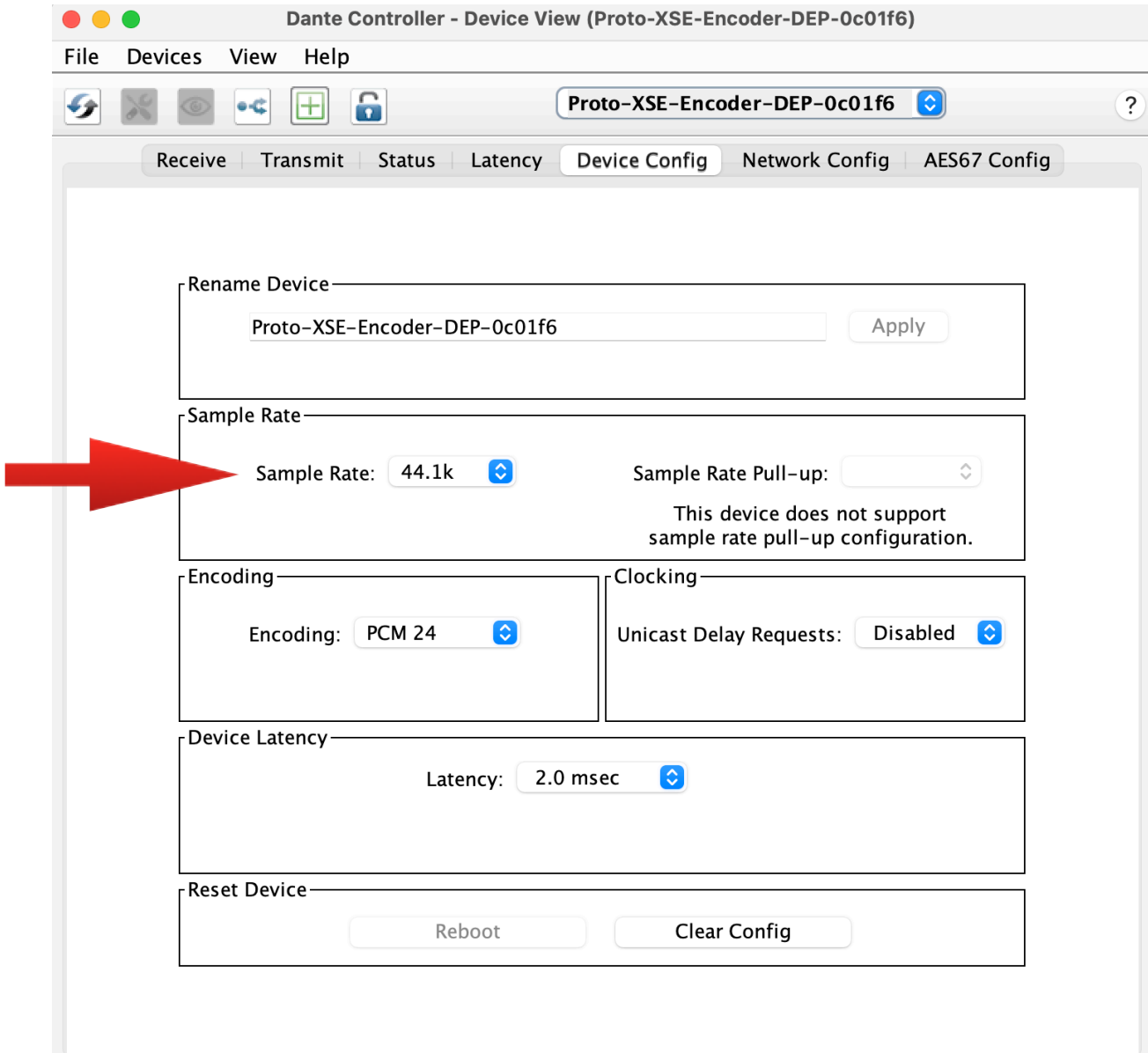

Incorrect setting of the **Sample Rate** field will cause a Dante Transmitter to not see audio as available to transmit.

Incorrect setting of the **Sample Rate** field will cause a Dante Receiver to not receive audio from a Dante Transmitter.

Dante API Commands

The following are important API commands related to Dante operation on supported ZyPer4K-XSE Encoders and Decoders.

To have Dante on the primary 10G Network

API Command:

set device NAME utilityPort enabled

(Note can also set this from ZMP GUI. See images below)

To have Dante on the 1G Utility port (Separate LAN)

API Command:

set device NAME utilityPort onlyDanteAudio

(Note can also set this from ZMP GUI. See images below)

Encoder Commands

Transmitter Function

Set the source for the transmitter to use for Dante audio. Options are HDMI input or Analog audio input.

Select HDMI

set encoder ENC_NAME danteAudioOut hdmiAudioDownmix

Select Analog Audio

set encoder ENC_NAME danteAudioOut analogAudio

Encoder Commands

Receiver Function (Receive Dante Audio from another source and output on Analog port)

set encoder ENC_NAME analogAudioOut source directDanteAudio

Receiver Function (Receive Dante Audio from another source and route to Z4K Decoder)

join ENC_NAME DEC_NAME danteAudio

set decoder DEC_NAME hdmiAudioOut source danteAudio

Decoder Commands

Transmitter Function

set decoder DEC-NAME danteAudioOut source hdmiAudioDownmix

ZyPer4K

**Decoder Commands
Receive Function**

set decoder DEC_NAME analogAudioOut source directDanteAudio
set decoder DEC_NAME hdmiAudioOut source directDanteAudio

Note: You can use both commands above at the same time. This will provide Dante audio out from both HDMI and Analog Audio Ports

Setting up ZyPer4K in Many to Many Environment

A many to many, or switched environment involves connecting many sources to many displays. ZyPer4K allows you a flexible and scalable amount of input-output options without limitations. For example, in a 24-port configuration, you can configure a 1x23, 6x18, or 4x20 (and so on) system. A network switch is needed in these many to many configurations. These environments also require configuration through the ZyPer4K management software.

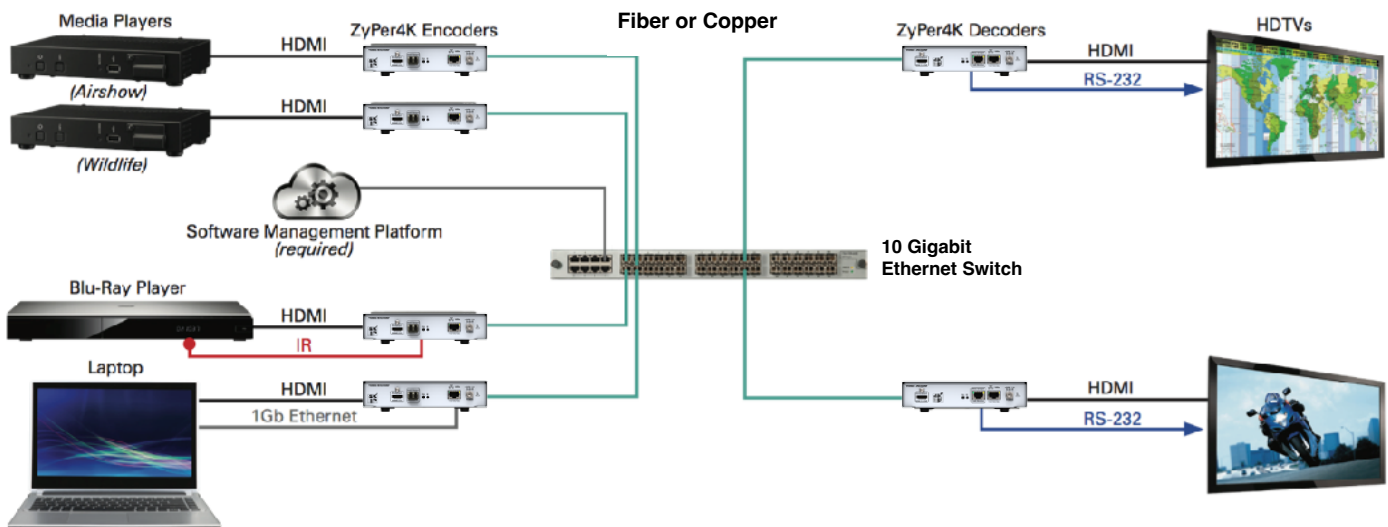

To set up ZyPer4K in a multipoint environment, you have to:

- Connect the ZyPer4K Management Platform hardware to the network switch
 - Determine the IP Address of the ZMP (See the Management Platform User Guide for details)
- Connect all Encoders and Decoders to the 10Gb network switch
- Connect a PC or Laptop to the network switch.
 - Make sure laptop is on same “network” as the MP
 - Open a Chrome browser and point it to the IP Address of the MP. (This opens ZyPer Management Platform (ZMP))
 - Login to the MP using the default username and password. “admin” / “admin”
 - All devices (encoders and decoders) will automatically appear in ZMP

ZyPer4K

- Switch (or route) video from sources to displays
- Drag source onto display to route video/audio

IP Address of MP

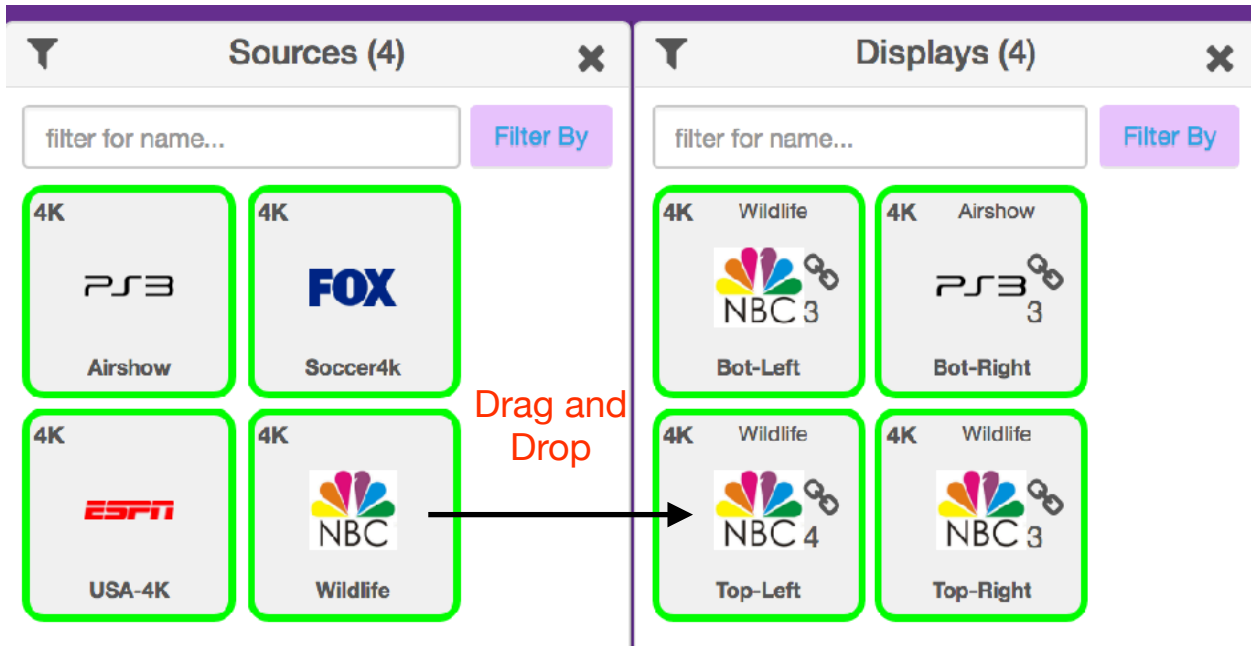
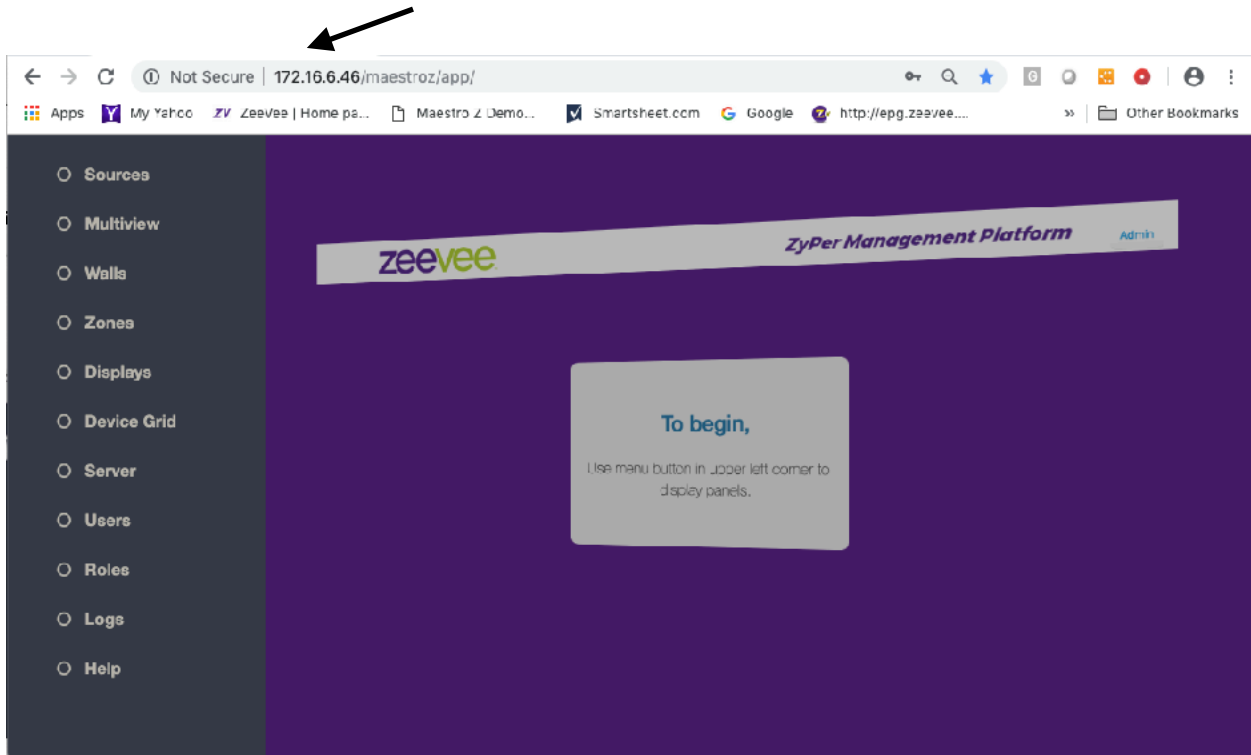

ZyPer4K

Please consult the *ZyPer Management Platform User Manual* for additional details on switching/routing video from sources to displays.

Please consult the *ZyPer4K Network Requirements and Security Considerations* document for details on Network switch requirements.

Both documents are available on the ZeeVee website:

<https://www.zeevee.com/documentation>

Icron USB Details (Optional Feature most units)

The ZyPer4K provides for USB-over-LAN communications using an optional Icron chipset.

The ZyPer4K Encoder contains a Virtual USB Hub while the ZyPer4K decoder contains a USB Host. This configuration provides support for connecting an Encoder to up to 7 Decoders. The total number of connected USB devices is limited to USB bandwidth.

Maximum number of supported USB Hops is 5. However 2 hop are already in the ZyPer4K unit.

Device types include the following:

- USB Keyboard
- USB Mouse
- USB Pen Tablet & Signature Pad
- USB Card Readers
- USB Flash Memory
- USB Hard Disk
- USB CD-ROM
- USB Camera

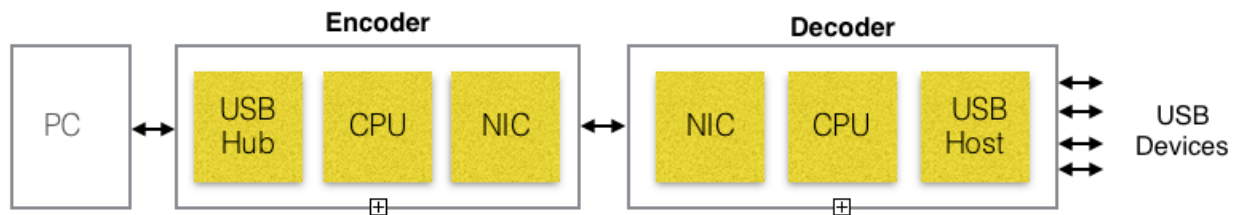

Important Notes: The Icron USB chipset requires it's own independent IP address. This address can only be obtained via a DHCP server, or alternately it will take a Link-Local address.

The ZyPer4K unit itself should never be assigned a Static IP address if the Icron USB chipset is installed. The ZyPer4K should be set to use DHCP or Link-Local.

ZyPer4K video/audio stream can be routed between subnets if the Network and Z4K units are configured properly. **However the Icron USB chipset signals cannot be routed between subnets.**

ZyPer4K-XSE Ability to Disable Icron:

Some ZyPer4K-XSE units are available with a combo card that provides support for both Icron USB and Dante. The Icron USB function can be disabled if there is a desire to maintain USB compatibility with other ZyPer4K-XS/XSE units that do not have this combo card option installed.

USB Details (Standard Feature XS/XR units)

The ZyPer4K provides for USB-over-LAN communications.

The ZyPer4K Encoder contains a USB Device Port while the ZyPer4K decoder contains a USB Host. This configuration provides support for connecting an Encoder to a single Decoder. The total number of connected USB devices is limited to 2 per decoder.

Device types include the following:

- USB Keyboard
- USB Mouse
- USB Touch Panels

Note: ZyPer4K-XS/XR units only support USB communication between other ZyPer4K-XS/XR units. Also supports USB to Wallplate units not containing the Icron chipset.

ZyPer4K USB Interoperability

The chart below details USB interoperability between ZyPer4K USB enabled endpoints. Please note the updated ZyPer4K-XSE units can disable Icron function if desired.

			Decoders						
			Z4K-XS	Z4K-XSE	Z4K-XSE Dante+Icron	Z4KXS-WallPlate	Z4KXS-WallPlate Icron	Z4K-Icron	Z4K-XR
USB Routing		Applicable Models	Z4KDECC3XS Z4KDECF3XS	Z4KCXS-D Z4KFXS-D Z4K2XS-D Z4KF2XS-D	Z4KCXS-DAU Z4KFXS-DAU Z4K2XS-DAU Z4KF2XS-DAU	Z4KDECC3XS-WPUS	Z4KDECC3XS-WPUS-I	Z4KDECF3U Z4KDPDEC3U Z4KDECC3U Z4KDPDEC3U	Z4KDECC3XR Z4KDECF3XR Z4KDECF3XR
Encoders	Z4K-XS	Z4KENCC3XS	Yes	Yes	Yes (Disable Icron)	Yes	No	No	Yes
		Z4KENCF3XS							
	Z4K-XSE	Z4K2XS-E	Yes	Yes	Yes (Disable Icron)	Yes	No	No	Yes
		Z4KF2XS-E							
	Z4K-XSE Dante+Icron	Z4K2XS-EAU	Yes (Disable Icron)	Yes (Disable Icron)	Yes	Yes (Disable Icron)	Yes	Yes	Yes (Disable Icron)
		Z4KF2XS-EAU							
	Z4KXS-WallPlate	Z4KENCC3XS-WPUS	Yes	Yes	Yes (Disable Icron)	Yes	No	No	Yes
	Z4KXS-WallPlate-Icron	Z4KENCC3XS-WPUS-I	No	No	Yes (USB 2.0 only)	No	Yes	Yes	No
	Z4K-Icron	Z4KENC3U	No	No	Yes (USB 2.0 only)	No	Yes	Yes	No
		Z4K12GSDIENCF3U							
		Z4K12GSDIENCC3U							
		Z4KDPENCF3U							
		Z4KDPENCC3U							
Z4KANLENC3U									
Z4KANLENC3U									
Z4KHDMIENCC3U									
Z4KHDMIENCF3U									
Z4K-XR	Z4KENCC3XR	Yes	Yes	Yes (Disable Icron)	Yes	No	No	Yes	
	Z4KENCF3XR								
	Z4KENCF3XR								

ZyPer4K

Red = USB not supported between devices

Yellow = USB HID supported between devices (May require Icron to be disabled in XSE unit)

Green = Full USB 2.0 support between devices.

Blue = USB Host port does not support direct connection to a USB 3.0 port. USB Hub is required between encoder and PC.

Important Note on ZyPer4K-XSE Decoders

ZyPer4K-XSE models with Icron has a limitation when used with the Icron chipset implemented in non-XS ZyPer4K units. This impacts the following part numbers.

Part Numbers:

Z4KCXS-DAU (Semtech and Icron USB)

Z4KFXS-DAU (Semtech and Icron USB)

USB Limitation:

When the ZyPer4K Encoder is a “white box” or “Wall plate”; the Icron enabled XSE decoder USB feature will only work with USB 2.0 devices connected to it. Decoder will not function with USB 1.0 or USB 1.1 devices. Devices such as keyboards and mice.

Workaround: Connect an external USB HUB to the ZyPer4K-XS Decoder. This will allow any USB 1.0, 1.1 or 2.0 device to function properly. Kramer will add an internal USB hub in an upcoming revision of the ZyPer4K-XS hardware.

Updated Part Numbers:

Z4KC2XS-DAU (Semtech and Icron USB)

Z4KF2XS-DAU (Semtech and Icron USB)

Note: Connection of external USB HUB should only be done while the ZyPer4K unit is powered off. Do not hot plug USB HUB into ZyPer4K.

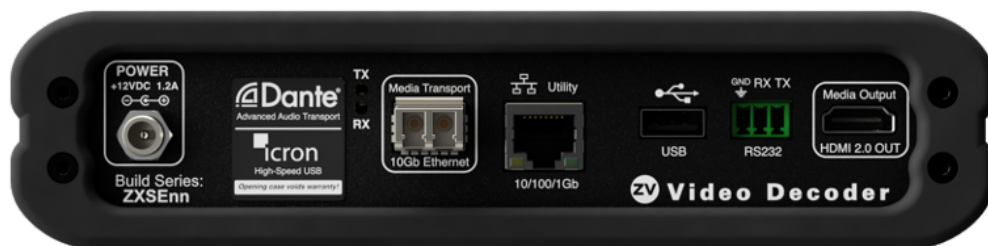

Technical Specifications

Encoder and Decoder HDMI Video Specifications

All encoders and decoders have one exposed HDMI port. It is an input on the encoder and an output on the decoder. All the parameters in terms of the formats of video and audio carried are the same for either.

HDMI	ZyPer4K		
	Enc	Dec	
HDMI Standard Port	✓	✓	HDMI 2.0 with HDR* and HDCP 2.2 Support
Direction	✓		Input
		✓	Output
Connector	✓	✓	Type-A receptacle (female)
HDMI Resolutions (USB-C support on XS and wallplate encoder)	✓	✓	<p>Supports all major VESA resolutions and variations including full HDMI 2.0 and HDR* support:</p> <p>640x480 (p/i) 720x576 (25Hz/50Hz)(p/i) 800x600 (p) 1024x768 (p) 1280x720 (p/i) 1280x1024 (p) 1366x768 (p) 1440x1080 (p) 1600x1200 (p) 1920x1080 (p/i) Including 120 Hz, 144 Hz and 240 Hz 2560x1440 (p) Including 120 Hz and 144 Hz support 2048x1536 (p) 3840x2160 (p) Including 4:4:4, 60 Hz support 4096x2160 (p) Including 4:4:4, 60 Hz support</p> <p>all at 24/25/29.97/30/50/59.94/60Hz refresh rates except where noted HDR fully supported in “Genlocked” mode HDR inputs reduced to 8-bits on output in “Fast-Switch mode”</p>

ZyPer4K

HDMI	ZyPer4K		
	Enc	Dec	
HDMI Audio	✓	✓	<p>All encoded audio formats plus LPCM (8 channels) (HDMI to HDMI audio is “passed-through” from encoder to decoder)</p> <p><i>Additional restrictions may result from the audio supported at encoder’s input.</i></p>

Decoder DisplayPort Video Specifications

DisplayPort	ZyPer4K	
	Dec	
DisplayPort	✓	DisplayPort 1.2a with HDR*
Direction	✓	Output
Connector	✓	Type-A receptacle (female)

ZyPer4K

DisplayPort	ZyPer4K	
DisplayPort Resolutions	✓	<p>Supports all major VESA resolutions and variations including full HDR* support:</p> <p>640x480 (p/i) 720x576 (25Hz/50Hz)(p/i) 800x600 (p) 1024x768 (p) 1280x720 (p/i) 1280x1024 (p) 1366x768 (p) 1440x1080 (p) 1600x1200 (p) 1920x1080 (p/i) 2048x1536 (p) 3840x2160 (p) Including 4:4:4, 60 Hz support 4096x2160 (p) Including 4:4:4, 60 Hz support</p> <p>all at 24/25/29.97/30/50/59.94/60Hz refresh rates except where noted HDR fully supported in “Genlocked” mode HDR inputs reduced to 8-bits on output in “Fast-Switch mode”</p>
Additional Specs		<p>5.4Gbps, 4-Lane DP/eDP Transmitter</p> <ul style="list-style-type: none"> - Compliant with VESA DP/eDP Standard V1.2a - DP/eDP Link Clock Frequency up to 540 MHz - 6-bit, 8-bit, 10-bit and 12-bit Deep Color modes - Single Stream Transport (SST)

Physical and Environmental

The following parameters apply to all encoders and decoders unless specifically stated otherwise.

Type	Parameter
A/C Adapter	100-1240VAC 50-60Hz 0.7-0.45A draw on AC Mains Output Max: 12VDC 2.5A
ZyPer4K unit power consumption	12VDC at 1.2A max 12W nominal (Standard Fiber Encoder/Decoder) 12VDC at 1.6A max 15W nominal (Standard Copper Encoder/Decoder) 12VDC at 1.2A max 12.5W nominal (Extended input Fiber Encoder) 12VDC at 1.6A max 15.5W nominal (Extended input Copper Encoder) USB Option (Adds 660mW power to above versions) 12VDC at 1.5A max 8.2W nominal (XS/XR version Encoder/Decoder) 12VDC at 2.2A max 12.0W nominal (XSE Encoder/Decoder) 24VDC at 1.0A max 9.0W nominal (Wall plate Encoder/Decoder) Note: Connecting USB devices to Decoders can add up to 5.0W of power.
Dimensions (LxWxH) maximum envelope	144mm x 175mm** x 43mm* (Decoder/Encoder with no extended input option) 144mm x 228mm** x 43mm* (Encoder with extended input option) 145mm x 164mm x 44mm* (Quiet/Fanless Decoder) 116mm x 199mm x 47mm (XS encoder/decoder) 136mm x 199mm x 48mm (XSE encoder/decoder) 199mm x 220mm x 71mm (XR encoder/decoder) 123.9mm x 171.5mm x 45.9mm (US Wallplate HxWxD) 86mm x 222.5mm x 45.9mm (EU Wallplate HxWxD) *subtract 6mm from height if rubber feet are removed ** add 48mm to overall width if both mounting ears are installed
Weight	880g (Decoder, Encoder with no extended input option) 850g (Quiet/Fanless Decoder) 1070g (Encoder with extended input option) 850g (XS Encoders and Decoders) 1000g (XSE Encoders and Decoders) 2100g (XR Encoders and Decoders)
Operating Temperature	0° C to +40° C (32° F to 104° F)
Non-Operating Temp	-20° C to +80° C (-4° F to +176° F)
Humidity (op/storage)	20% to 90% (Non-Condensing)
Coating	White, satin anti-microbial powder coat Black, anti-microbial powder coat (Quiet/Fanless Decoder and XS/XSE/XR units)

General Safety and Care Instructions

Safety

WARNING: When using electronic products, basic precautions should always be followed, including:

- Keep these instructions.
- Heed all warnings.
- Follow all instructions.
- Do not use this apparatus near water.
- Clean only with in accordance with cleaning instructions included in this manual.
- Do not block any ventilation openings. Install in accordance with the manufacturer's instructions for spacing and clearance to allow proper airflow.
- Do not install or place this product near any heat sources such as radiators, heat registers, stoves, or other apparatus (including amplifiers) that produce heat.
- Do not defeat the safety purpose of the grounding-type plug. A grounding type plug has two blades and a third grounding prong. The third prong is provided for your safety. If the provided plug does not fit into your outlet, consult an electrician for replacement of the obsolete outlet.
- Power cord must be accessible to allow for the removal of the power from the unit.
- Protect the power cord from being walked on or pinched, particularly at plugs, convenience receptacles, and the point where cords exit from the apparatus.
- Unplug this apparatus during lightning storms.
- Unplug this apparatus when unused for long periods of time.
- Only use attachments/accessories supplied or specified by the manufacturer.
- Refer all servicing to qualified service personnel. Servicing is required when the apparatus has been damaged in any way, such as power-supply cord or plug is damaged, liquid has been spilled or objects have fallen into the apparatus, the apparatus has been exposed to rain or excessive moisture, does not operate normally, or has been dropped.



WARNING: To reduce the risk of fire or electric shock do not operate this apparatus in a position where it is exposed to dripping or splashing liquids, rain, moisture, or excessively high humidity. Objects containing liquid shall not be placed in proximity to the unit such that they present a risk of spillage onto the apparatus.

Shock and Fire Hazard:

The unit's metal case, power supply, and grounding terminals and lugs are essential in containing radio energy as well as safeguarding the user from any risk of electrical shock. The metal shell of the unit protects the internal circuitry from environmentally induced over stress conditions and is an integral part of the compliant system.



WARNING: Do not open the box or in any way expose the internal circuitry.



WARNING: There are no user-serviceable parts inside the unit. Opening or damaging the ZyPer4K unit in any way voids the warranty and immediately nullifies any assertion of regulatory compliance made by ZeeVee. Any required service shall be performed by trained and qualified service personnel authorized by ZeeVee.



Cleaning

Encoder, Decoder and ZyPerMP Unit Cleaning Procedures

Before cleaning:



1. Switch off or fully disconnect the AC power from the external supply unit connector to the ZyPer unit.
2. If the state of the AC power cannot be established, disconnect the DC input plug from the ZyPer unit before proceeding.

Cleaning Procedure:

1. Any unused cable receptacles should be covered with the supplied rubber plugs or a piece of tape to prevent cleaner from entering and possibly affecting operation.
2. Clean the exterior of the unit with a soft cotton cloth that has been lightly moistened with an approved and recognized cleaning agent.

The exterior of the unit has been tested for compatibility with, and resistance to, the following products:

- ◆ Alcohol (Isopropyl and Ethyl)
- ◆ Ammonia-based cleaners (Windex)

In case none of the above cleaning products is available, water may be used.

The ZyPer4K unit is fairly tolerant to cleaning with moistened cleaning cloths, but the unit is not fluid tight. Care should be taken to not spray cleaner directly on to the unit or into the vents to avoid liquid ingress and damage to the internal electronics.



CAUTION: Do not apply or spray liquid directly on to the unit's exterior as excess liquid may cause damage to internal electronics. Apply the liquid to the cleaning cloth first.

3. Repeat with water-moistened cloth only.
4. Wipe with a dry cloth

5. Air vents shall be checked to make sure that they are free of accumulated lint or blockages.

Should the air vents appear clogged use a vacuum cleaner with a soft-bristle brush attachment to loosen and draw the debris out of the vents and away from the unit.

Do not loosen and blow the debris in to the unit as internal buildup of debris will degrade the ability of the unit to cool itself and reliability may be adversely affected.

Do not apply power if there is any evidence of fluid in the interior of the unit.

ZyPerMP Specific Cleaning Procedure



The ZyPerMP control unit is not designed to be placed in an environment that would subject it to impurities that require as frequent cleaning as the encoder and decoder units. Should the ZyPerMP unit need cleaning, the same procedures apply as enumerated above, only a very sparing amount of cleaner should be applied to the cleaning cloth.

Important Siting and Application Considerations

ZyPer4K Equipment Type and Uses

ZyPer4K Intended Uses

- Equipment is intended for the distribution of Audio Visual Information in and around a facility.
- Equipment is intended to distribute Human Interface and control information over the same network as the Audio Visual information following the same or different logical distribution paths.
- Equipment does not generate video information itself, but accepts and distributes video information from industry-standard devices which generate such audio visual information.
- Equipment is intended for the sophisticated display and presentation of decoded information that has been distributed by companion ZyPer4K equipment.
- Equipment is intended to be controlled from a central control node (the ZyPerMP) which ties in to a customer control system for sophisticated presentation and management of the information flow and direction.



WARNING: The installer should test and validate a complete setup with the actual devices before deploying to a final production installation.

Installation Environment

The general area where the ZyPer4K unit is to be installed shall be clean and free of obstructions or clutter.

Mounting Options

- Unit may be mounted horizontally on the installed rubber feet
- Unit may be bolted to a horizontal surface using the provided L-brackets with or without feet installed.
- Unit may be mounted vertically only if appropriate clearance is provided around the grille work for adequate airflow. The appropriate ZyPer4K rack mount kits insure that airflow space is sufficient when mounting vertically.
- Units may be stacked in a horizontal orientation providing stack is no higher than 3 units when using the provided rubber feet
 - Greater stacking requires that the user remove the rubber feet and externally bracing the stack of units.
- In all cases, insure that the units are rigidly held in place and will not be subject to impact and there is no possibility of toppling.
- Do not stack any other equipment or devices on top of the unit weighing more than 3Kg and only if sufficient bracing is provided to protect against toppling.



WARNING: Failure to adhere to these recommendation could result in unsafe operation, damage to the equipment, or injury to the operators.

Mounting Brackets

Standard units only. XS, XR and Silent Decoder units not supported.

ZyPer4K equipment may be used horizontally and simply sit upon the rubber feet that are factory installed. It is recognized that in some sites a more rigid and secure installation is desired. To that end, there are available L-shaped brackets which may be optionally used to rigidly affix the unit to a shelf, wall, or any sturdy surface.

Part number for the L-shaped brackets is Z4KCMNTBRKT

It is up to the installer to provide the appropriate screws or bolts to affix the unit to whatever surface it is to be mounted.

ZyPer4K

The optional L-Brackets allow for the ZyPer4K unit to be rigidly mounted flat to a cart, plate, wall, or any type of flat surface. The hole, cross, and slot cutouts allow for great flexibility in mounting.



When using the L-Brackets, first remove the screws and rubber feet on the bottom of the unit. Retain the screws as they will be used to affix the L-Brackets to the ZyPer4K unit body. The rubber feet are not used when mounting with the L-Brackets.

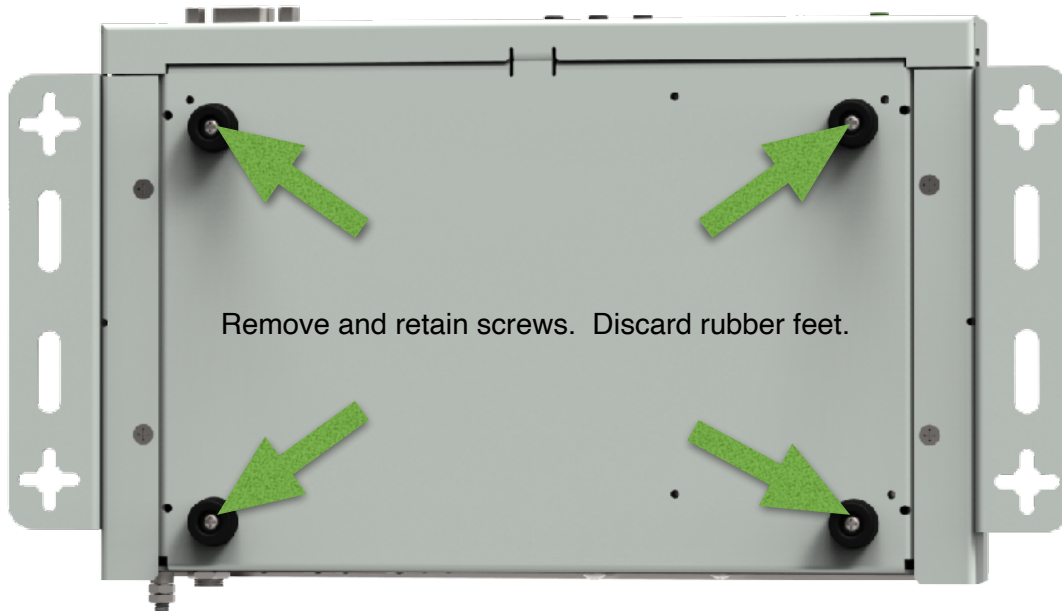

ZyPer4K

Affix the L-Brackets to the sides of the unit using the retained screws from the rubber feet (repeat for each side).



Recommended mounting hardware for rigid mount

The installer must provide the appropriate hardware to mount the L-Brackets to whatever surface is used.

Drywall: When mounting to drywall, ZeeVee recommends use of Drywall anchors for #6 up to #10 hardware and washers appropriate to the size screw utilized. The recommended sequence of hardware would be; Drywall anchor, Flat Washer, ZyPer4K L-Bracket, Flat Washer, Screw or Bolt.

Sheet Metal Shelf or Equipment: #6 up to #10 thread-forming or thread-cutting machine screws. Pilot holes should be drilled using the equipment as an outline template. Should the removal of equipment periodically be required use thread-cutting screws. The recommended sequence of hardware would be; Flat Washer, ZyPer4K L-Bracket, Flat washer, Lock Washer (when using thread cutting screw), Screw or Bolt.

There should be 4 sets of screws and associated hardware in as “outboard” a position as is practicable.

VESA Mounting Bracket

There is an optional VESA mounting bracket available from ZeeVee for mounting most unit styles to shelves, walls or other sturdy surfaces as well as directly to VESA compatible displays. This VESA bracket is compatible with any standard size ZyPer4K encoder or decoder as well as Silent Decoder units. Extended box encoders and XR units are not supported.

Part number for this custom bracket is Z4KVESABRK

The VESA mounting bracket supports standard VESA parameters for mounting directly to rear of a display. 100x100, 100x200 and 200x200 VESA hole mounts are supported.

When using the VESA bracket, first remove the screws and rubber feet on the bottom of the ZyPer4K unit. Retain the screws as they will be used to affix the VESA bracket to the ZyPer4K unit body. The rubber feet are not used when mounting with the VESA bracket. XS units are mounted to the very center holes (either direction) and use the provided spacers.

Note that mounting ZyPer4K to the rear of display would use the available VESA mounting holes and may prevent the display from using these holes to mount the display to a wall. See examples on following page .

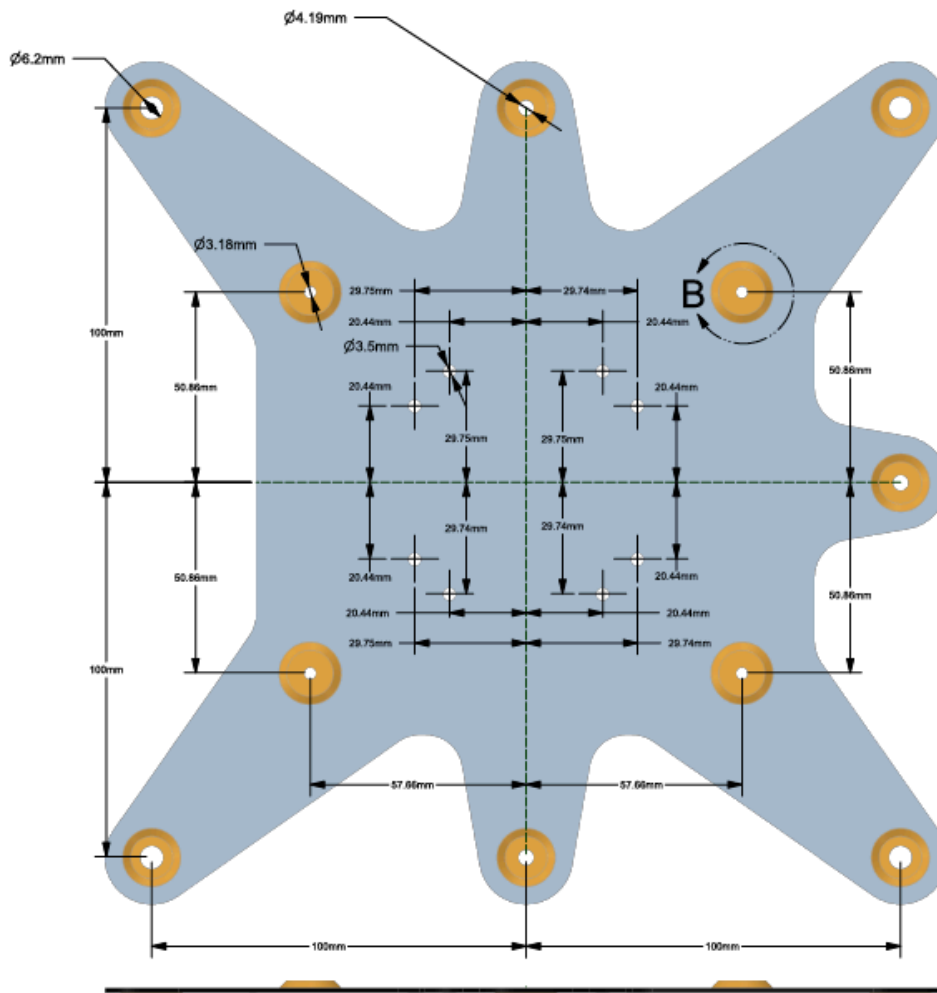

ZyPer4K

Example mounting ZyPer4K to center of 200x200 VESA bracket using all 4 mounting holes/screws. This would prevent the use of wall mounting bracket hardware.

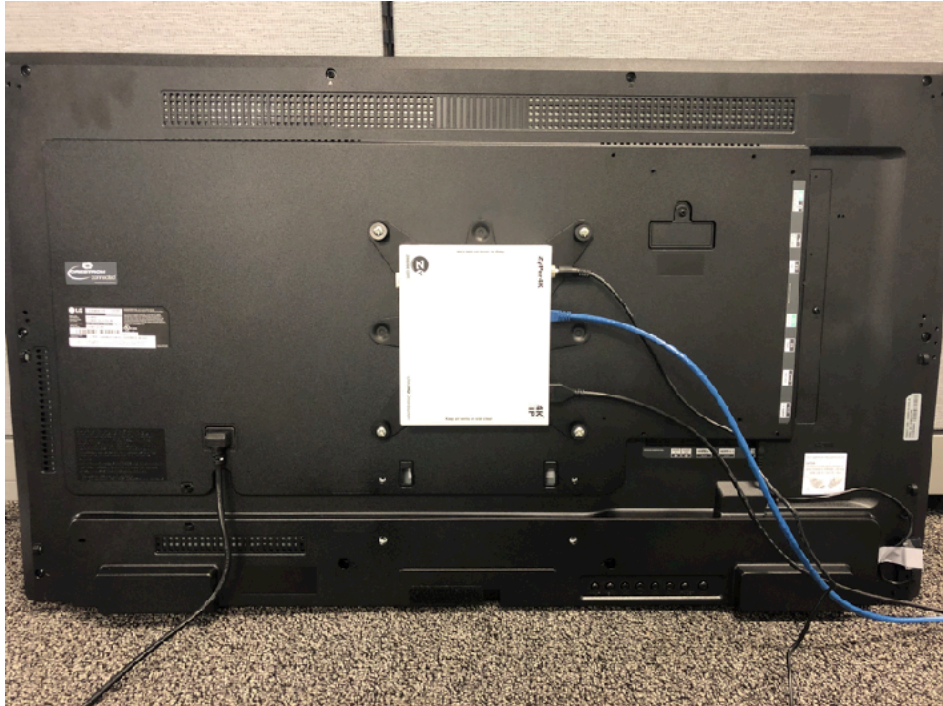

Example mounting ZyPerK to side of 200x200 VESA bracket using 2 mounting holes/screws. This *may* enable use of wall mounting bracket hardware.



Ventilation

Ambient environmental temperature and humidity shall not exceed that specified in the Detailed Specifications portion of this document.

Ambient temperature in this case refers to the temperature of air entering the device through the ventilation grille. Care should be taken to not enclose the device or deploy in a fashion where airflow loops or local “hot spots” can cause the inlet air to rise above the specified limit for normal operation.

In general 25mm (\approx 1inch) of clearance should be provided around the ventilation openings unless an external air mover insures that the inlet temperature is at or below the specified limit.

If the equipment is mounted in an enclosed cabinet, it is the job of the installer to insure that within the cabinet or enclosure the ZyPer4K equipment does not experience local temperatures in excess of that specified in the Detailed Specifications portion of this document.

Water and moisture

Never expose the ZyPer4K unit to direct rain, moisture, or excessively high humidity.

Never use the device near water - e.g. near a bathtub, basin, pool, sink, or in a wet basement.

Clean only in accordance with the instructions in this manual.

AC Mains Connection

The ZyPer4K Encoder and Decoder units are powered through an external AC/DC converter unit.

The Encoder and Decoder units must be powered and connected using the supplied external AC/DC converter. The voltage supplied to the Encoder and Decoder units from the external supply is 12VDC at less than 2.0A

- Do not substitute the supplied AC/DC power supply unit with another component. The overall system compliance is dependent on each of the provided elements being present and operational.



INFORMATION: The introduction of a foreign, non-ZeeVee element nullifies any claim of regulatory compliance asserted by ZeeVee.

The AC/DC power supply shall be powered from the appropriately rated AC mains voltage which allows for a wide range of input, generally from 100VAC through 240VAC.

Only use a power cord with an appropriately rated protective earth connection. The protective earth connection is essential to the overall safety of the system.



WARNING: Bypassing or omitting the protective earth connection increases the risk of electrical shock and radio emissions



Install the equipment in such a manner as the IEC power cord ingress in to the AC/DC adapter is accessible as this is the boundary of the AC mains system and the point at which the ZyPer4K equipment is disconnected from the AC mains power if needed.

The equipment should be installed as near as is practicable to an AC outlet.

- Do not substitute or extend the DC cable from the AC/DC unit.

The ZyPer4K system is intended and rated for continuous operation

Should the ZyPer4K equipment be unused for an extended period of time it should be disconnected from the AC mains at the AC inlet to the external AC/DC converter in order to protect the equipment from transient over-voltage conditions.

AC Power Cord

Connect the external AC/DC supply unit to the AC mains with a UL-listed detachable power cord, 3-wire, type SJ or equivalent, 18 AWG min., rated 250 V min., plug 5-15P configuration for 120V application, or 6-15P for 240V application.

AC/DC converter inlet side of AC cord shall be of type IEC320C13



- Do not overload wall outlets and extension cords.

Power cords should be routed so that they are not likely to be walked upon or pinched by items placed upon or compressing them.

Match the rating of the power cord to the voltage of the power outlet in accordance with the specific requirements and in compliance with safety standard of your particular country.

Equipotential Referencing

Safety and compliance with standards is highly dependent on the proper crafting of the electrical realm in which electrical equipment operates. It is also good practice to properly ground all electrical equipment.

The ZyPer4K equipment may be connected to the the known and common equipotential reference by bonding the devices electrically. This is achieved by connecting the equipotential plane reference to the unit via the equipotential stud.

The ZyPer4K devices all have a universal stud on the rear of the unit near the power connector for this purpose. Two nuts are also provided to allow for a “locking connection”. This stud is sized and threaded for #8 hardware.



This is a reference point that In order to insure the voltage potential of the enclosure of the ZyPer4K unit is referenced to a known common level.



The grounding wire and crimped lug is NOT provided as part of the ZyPer4K unit as that item is site-specific.

Installer-Required Action

If used, the installer must connect to the Equipotential Stud with a wire terminated with a crimped ring lug with internally toothed locking feature similar to the item shown. The locking feature insures the ring lug will not loosen over time given environmental handling or vibration.



ZyPer4K

The Equipotential Stud is an 8-32 threaded connection. Employ a ring lug of the proper diameter to insure the most reliable connection.

High-quality wire of 16 gauge or heavier is recommended by ZeeVee, It is the responsibility of the installer to determine the needs of the specific installation.

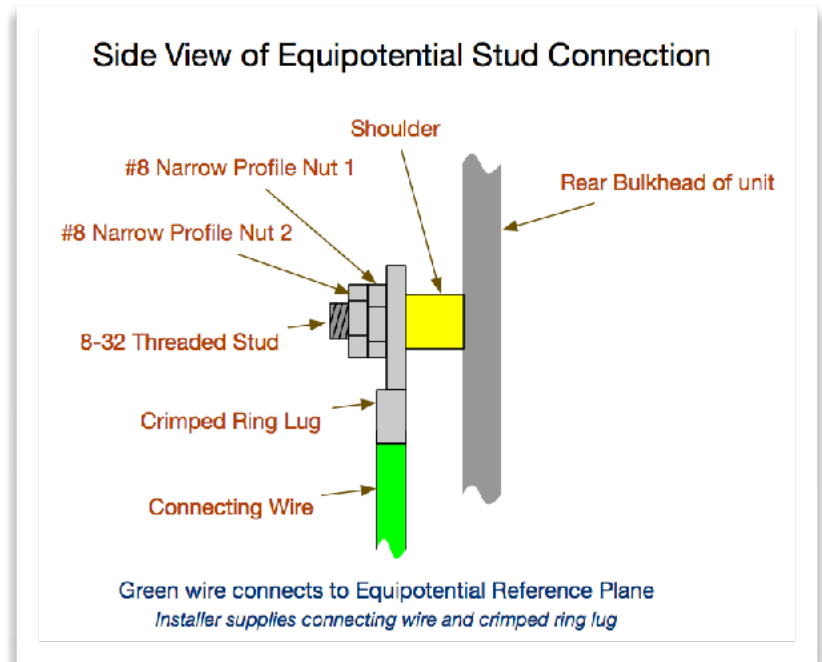

Responsibility and Stewardship

ZeeVee is committed to using the planet's resources efficiently and having as little negative impact on the environment and health of mankind as possible.

Our products consume very little energy and attempt to provide the highest level of function for the smallest investment in resources.

Reduction of Hazardous Substances (RoHS)

RoHS Directive 2011/65/EC, Directive 2002/95/EC, Directive 2003/11/EC

Product Lines:

ZyPer Products supplied by ZeeVee, Inc.

Material	Limit
Lead and its compounds (Pb)	<1000 ppm
Hexavalent Chromium and its compounds (Cr VI)	<1000 ppm
Cadmium and its compounds (Cd)	<100 ppm
Mercury and its compounds (Hg)	<100 ppm
Polybrominated diphenyl ethers (PBDEs)	<1000 ppm
Polybrominated biphenyls (PBBs)	1000 ppm
Bis(2-Ethylhexyl) phthalate (DEHP)	<1000 ppm
Benzyl butyl phthalate (BBP)	<1000 ppm
Dibutyl phthalate (DBP)	<1000 ppm
Diisobutyl phthalate (DIBP)	<1000 ppm

Be advised that based on the information available to ZeeVee from our component and sub-assembly providers, the product lines listed above do not contain as intentional additives, any of the referenced materials at the levels indicated, as referenced in the subject EU directives. To the best of our knowledge, none of these materials are generated during production and the supplied component parts of the ZeeVee products do not contain the listed materials. Since we do not expect these materials to be present, we do not specifically run a complete analysis on all finished goods, excepting for periodically auditing the finished goods and component materials in certain circumstances.

This information is believed to be accurate and refers to the laws, regulations and products at the date of issue. However, ZeeVee makes no express or implied representations or warranties with respect to the information contained herein. It is the responsibility of our customers to determine that their use of ZeeVee products is safe, lawful, and technically suitable for their applications. Because of possible changes in the laws and regulations, we cannot guarantee that the status of the listed products will remain unchanged.

Waste Electrical and Electronic Equipment

WEEE Directive 2012/19/EU on waste electrical and electronic equipment

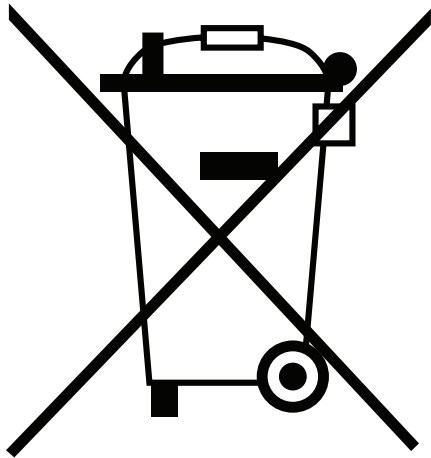

The WEEE Directives (2008/98/EC and 2012/19/EU) place an obligation on electrical equipment manufacturers and importers to recycle electronic products at the end of their useful life.

ZeeVee products that are marked with the WEEE symbol (see left) indicate that the product must NOT be disposed of with other household waste. Instead, it is the user's responsibility to dispose of their waste electrical and electronic equipment by handing it over to an approved re-processor or by returning it to an authorized agent of ZeeVee or their distributor for recycling. To prevent possible harm to the environment or human health from uncontrolled waste disposal, please separate these items from other types of waste and recycle them responsibly.

For more information about the recycling of this product, please contact your local waste disposal authorities or local municipal waste disposal service.

For specific questions related to WEEE compliance of ZeeVee products contact:
support@zeevee.com

This information is believed to be accurate and refers to the laws, regulations and products at the date of issue. However, ZeeVee makes no express or implied representations or warranties with respect to the information contained herein. It is the responsibility of our customers to determine that their use of ZeeVee products is safe, lawful, and technically suitable for their applications. Because of possible changes in the laws and regulations, we cannot guarantee that the status of the listed products will remain unchanged.

ZeeVee, Inc.
295 Foster Street, Littleton, MA 01460

FCC Compliance Statement

The ZyPer4K family of devices has been tested and found to comply with the limits for Class A Digital Devices pursuant to Part 15 of the FCC Rules. Operation is subject to the following conditions: 1) these devices may not cause harmful interference, and 2) these devices must accept any interference received including interference that may cause undesired operation.

This equipment generates, uses, and can radiate radio frequency energy and, if not installed or used in accordance with the instructions, may cause harmful interference to radio communications. However there is no guarantee that interference will not occur in a particular installation.

If this equipment does cause harmful interference to radio or television reception, which can be determined by turning the equipment off and on, the user is encouraged to try to correct the interference by one or more of the following measures:

1. reorient or relocate the receiving antenna
2. increase the separation between the equipment and the receiver
3. connect the equipment to an outlet on a circuit different from that to which the receiver is connected
4. consult the dealer or an experienced radio/TV technician for help.

Any changes or modifications not expressly approved by the party responsible for compliance could void the user's authority to operate the equipment. Where shielded interface cables have been provided with the product or specified additional components or accessories elsewhere defined to be used with the installation of the product, they must be used in order to ensure compliance with FCC regulations.



In order to insure compliance with the referenced FCC regulations, only deploy the equipment with provided or approved accessories in the manner indicated in this and other pertinent manuals.

Use only approved and properly shielded cables of good quality.

Address any inquiries to:

ZeeVee, Inc.
295 Foster Street, Suite 200
Littleton, MA 01462

EMC Information

The ZyPer4K devices should be mounted and operated in accordance with the guidelines specified in this guide to maintain the integrity of the expected EMC characteristics.

The supplied Power Supply (AC/DC Conversion unit) should be used. The ZeeVee 12V Rack Mount Power Supply (Z4KPWRCTR12) may also be used. Any other AC/DC supply has not been tested or verified to perform at the levels indicated in this manual.

Media cables are not provided and the ZyPer4K devices are generally fairly tolerant of different types and manufacture styles.

- Media cables should be of good quality and rated for the performance levels of the interface to which they are connected.
 - e.g. 4K HDMI ports should only be connected to HDMI cables rated for 4K operation at the desired resolutions.
 - e.g. 3G-SDI cables should be of the appropriated impedance and within the length restrictions of the greater 3G-SDI specification
- HDMI cables shall be of the type incorporating integral Ferrite cores in order to achieve rated compliance levels and the cleanest electromagnetic environment in the vicinity of the unit.

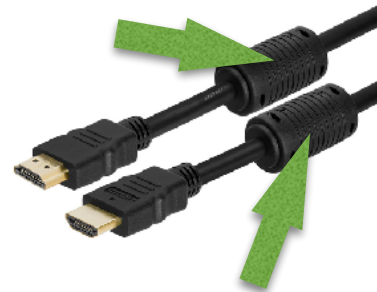

Electromagnetic Emissions

Test	Compliance Level	Notes
RF emissions: CISPR 11	Group 1	ZyPer4K emissions are very low and not expected to cause unintentional interference.
RF emissions: CISPR 11	Class A	Commercial equipment for use in commercial environments.
Harmonic emissions: IEC 61000-3-2	Class D	Suitable for use in all commercial and domestic low-voltage environments.
Voltage fluctuations/ flicker emissions: IEC 61000-3-3	Compliant	

Electromagnetic Immunity

Test	IEC Standard	EN60601 Compliance Level	Result	Deployment Note
Electrostatic Discharge (ESD)	61000-4-2	± 6kV contact ± 8kV air	PASS	Expect hard floor of wood, tile, ceramic, metallic material. If floor has synthetic covering, expected relative of humidity of 30% shall be maintained to avoid static charge buildup.
Radiated RF	61000-4-3	3 V/m 80 MHz to 2.5 GHz	PASS	Minimum separation guidelines should be observed if placing equipment close to intentional RF radiator.
Electrical fast transient/burst transient	61000-4-4	± 2kV for power supply lines ± 1kV for input/ output lines	PASS	Expected power quality typical for commercial facility.
Surge	61000-4-5	± 1 kV line(s) to line(s) ± 2 kV line(s) to earth	PASS	Expected power quality typical for commercial facility.
Conducted RF	61000-4-6	3 Vrms 150 kHz to 80 MHz	PASS	Minimum separation guidelines should be observed if placing equipment close to intentional RF radiator.
Power frequency (50/60 Hz) magnetic field	61000-4-8	3 A/m	PASS	
Voltage dips, short interruptions and voltage variations on power supply input lines	61000-4-11	<5% U_T (>95% dip in U_T) for 0.5 cycle 40% U_T (60% dip in U_T) for 5 cycles 70% U_T (30% dip in U_T) for 25 cycles < 5% U_T (>95% dip in U_T) for 5s	PASS	Typical commercial facility power expected. Good practice dictates that a UPS system shall be employed if continued operation through any possible AC delivery disturbance is desired.

Physical Dimension Diagrams

ZyPer4K Standard Size Units

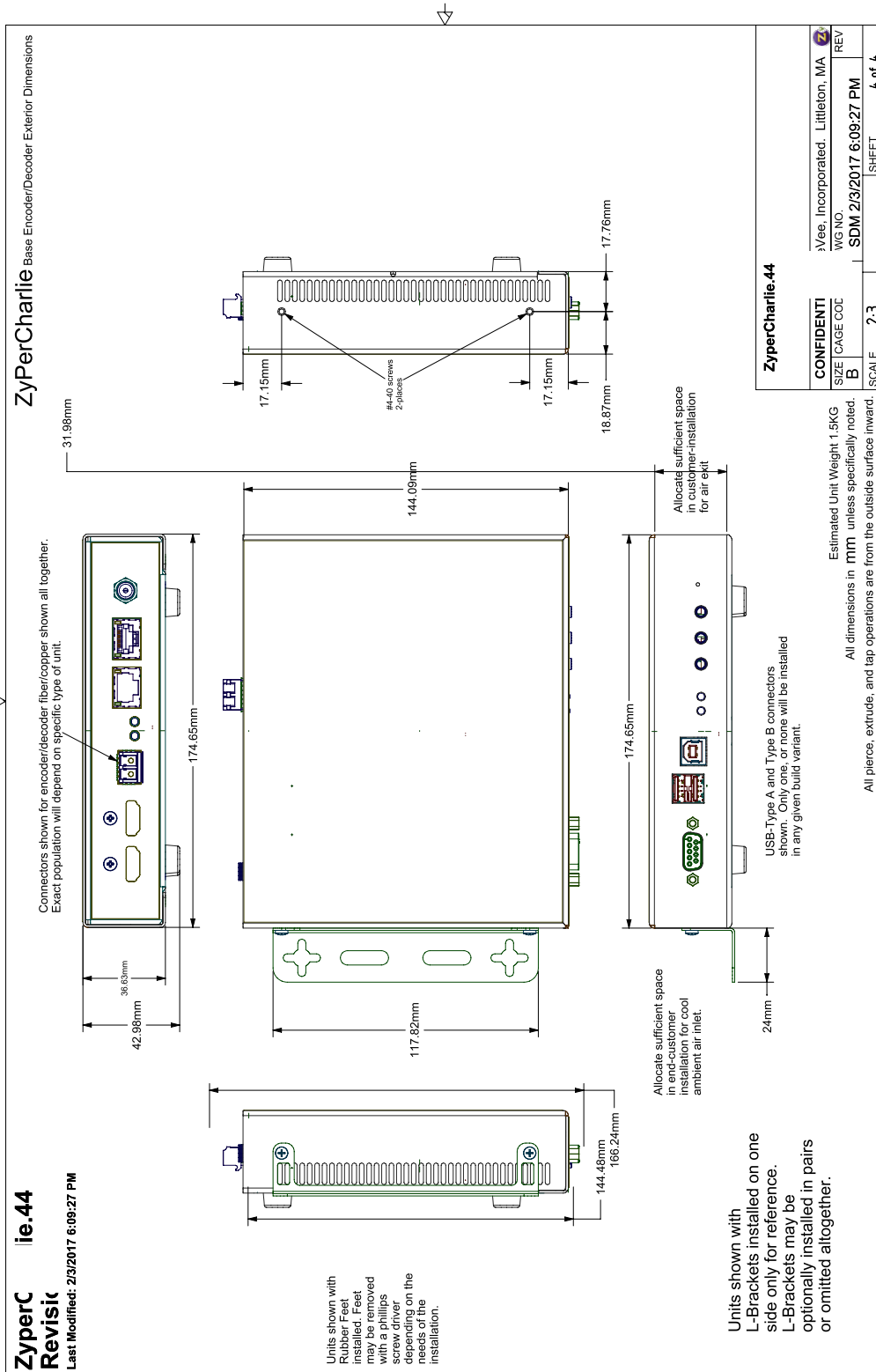

ZyPer4K Extended Size Units

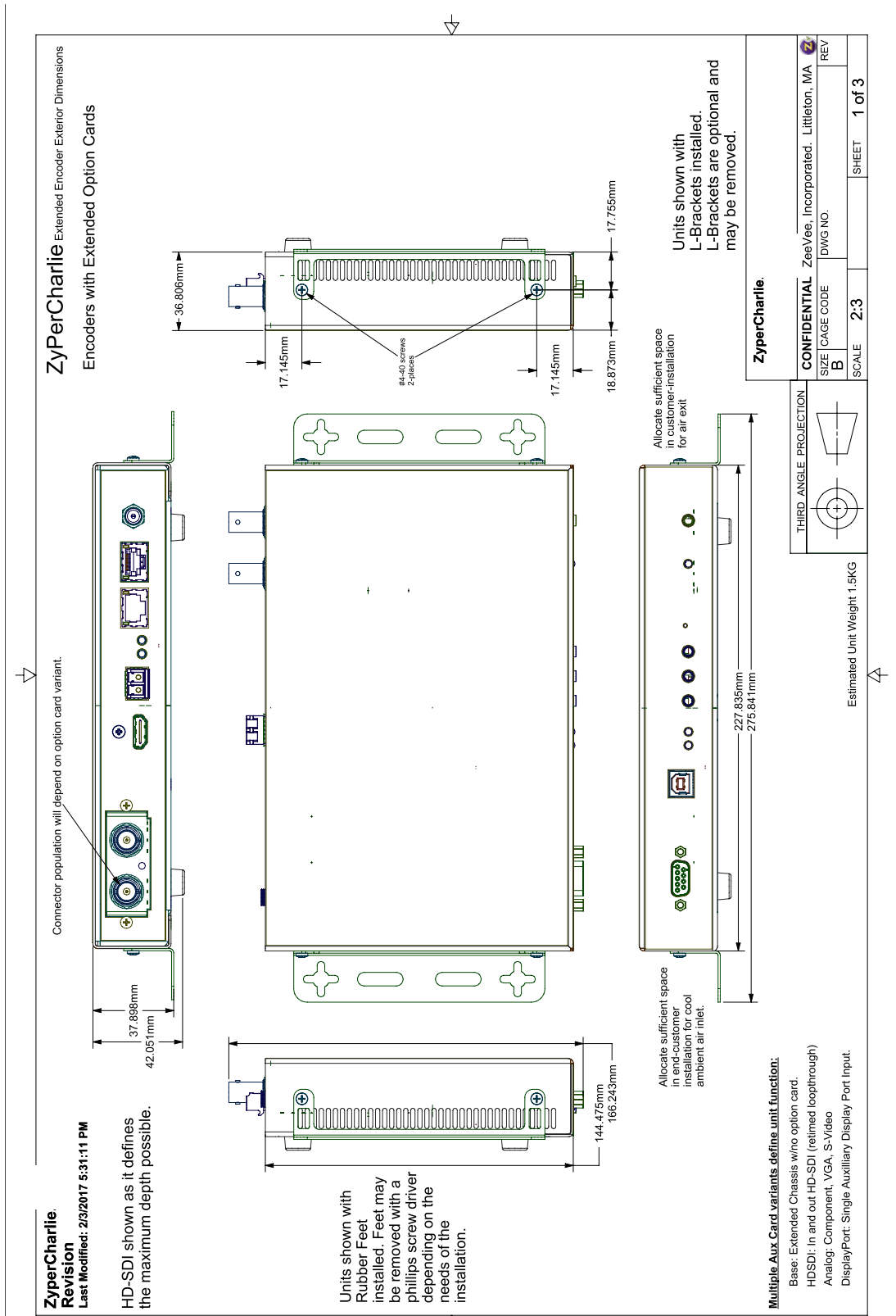

ZyPer4K

ZyPer4K XS Units

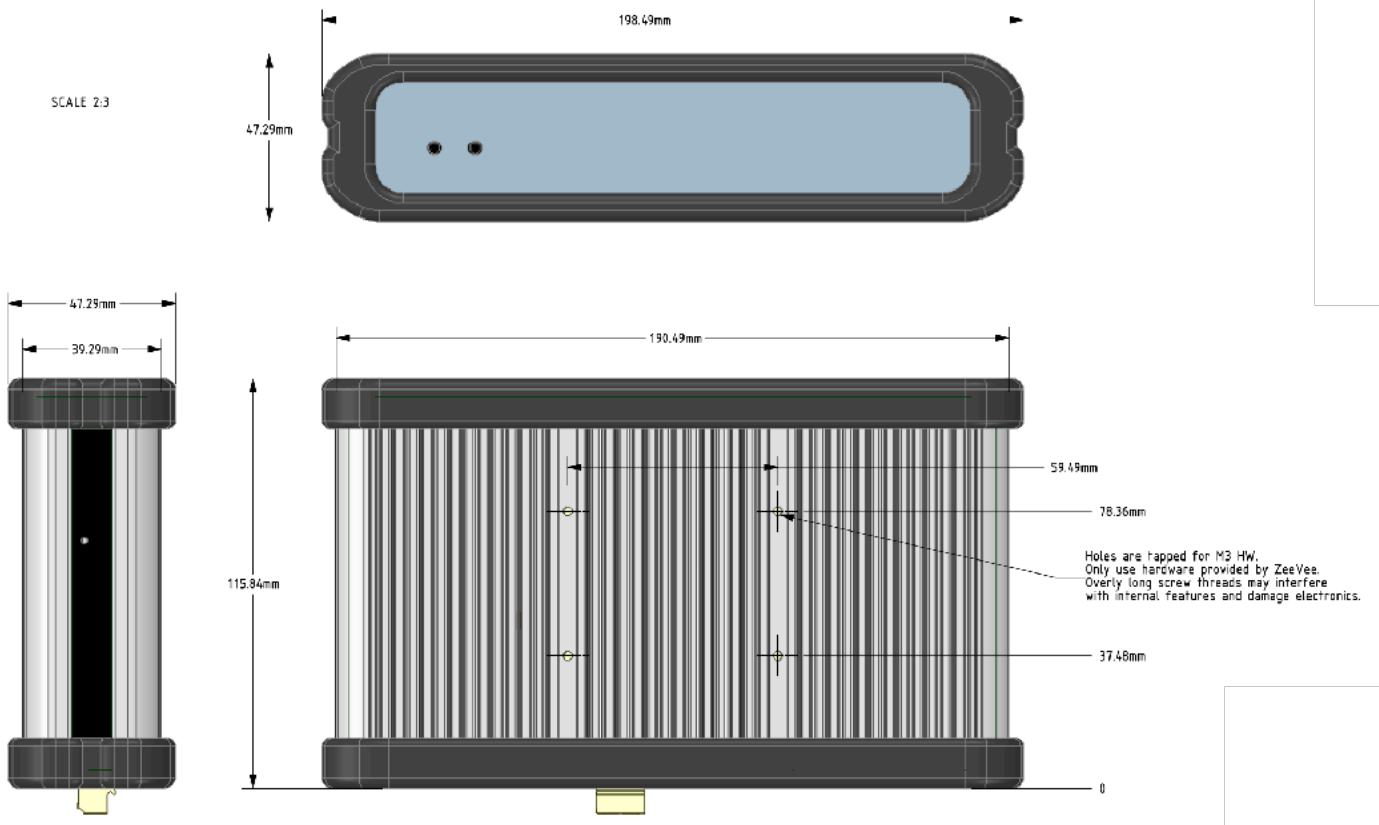

ZyPer4K

ZyPer4K XSE Units

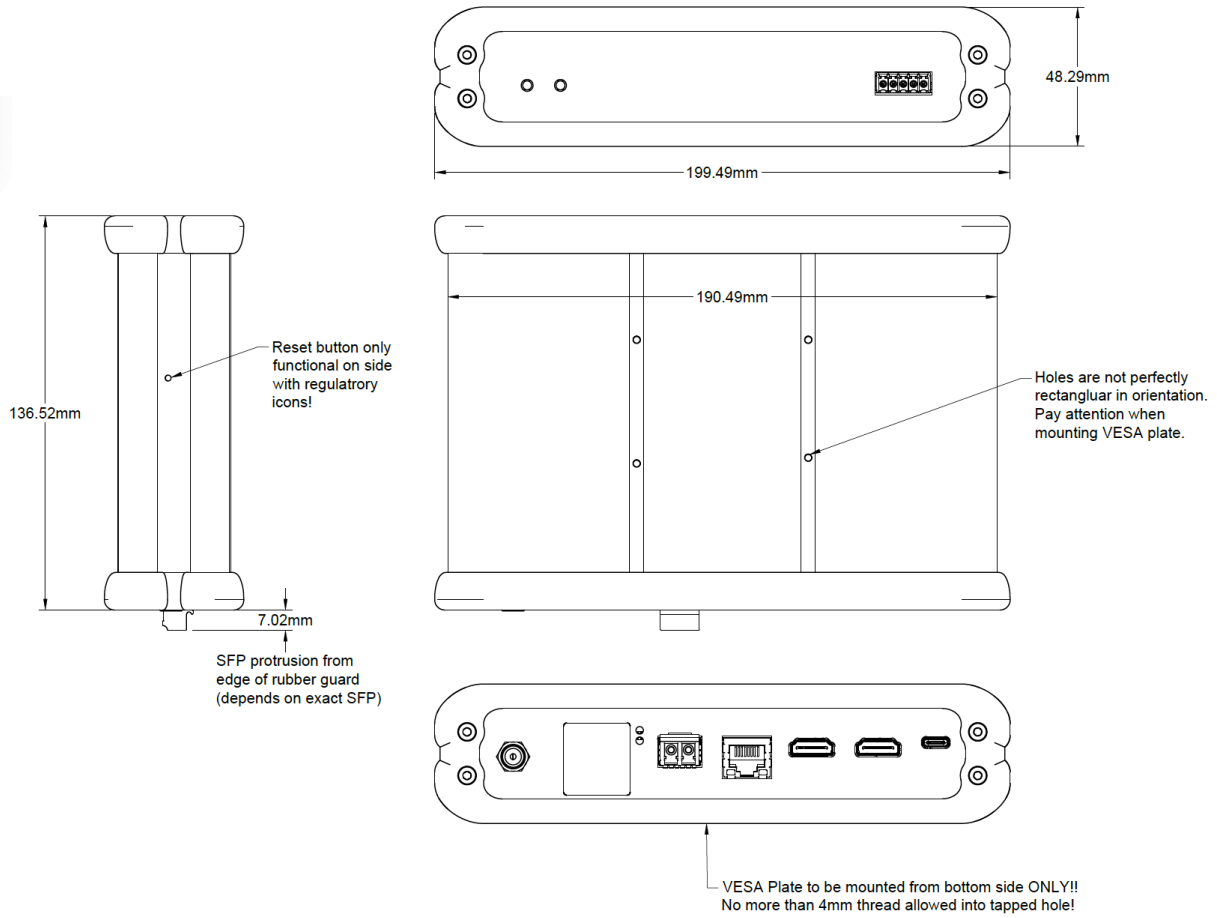

ZyPer4K

ZyPer4K XR Units

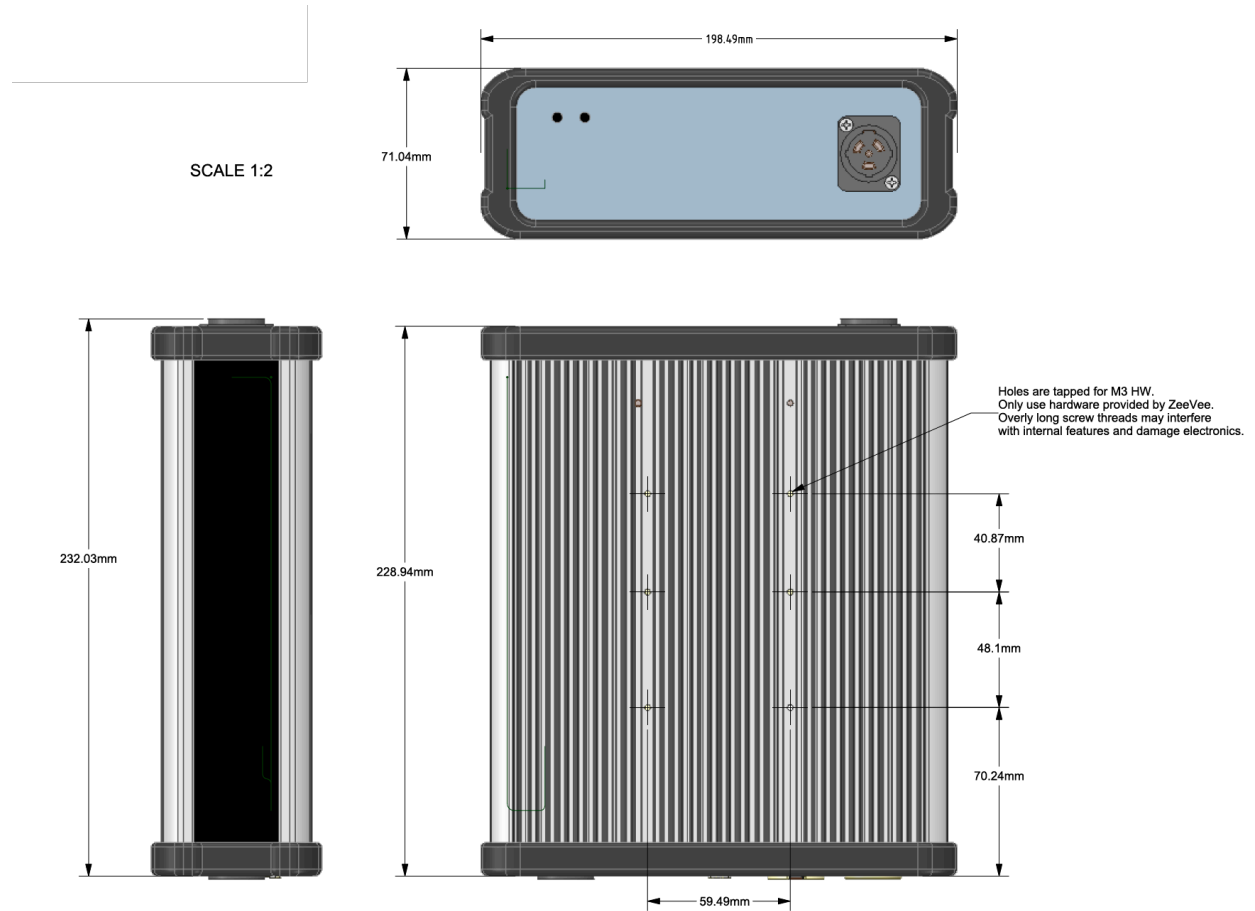

ZyPer4K

US Wallplate (Dimensions in millimeters)

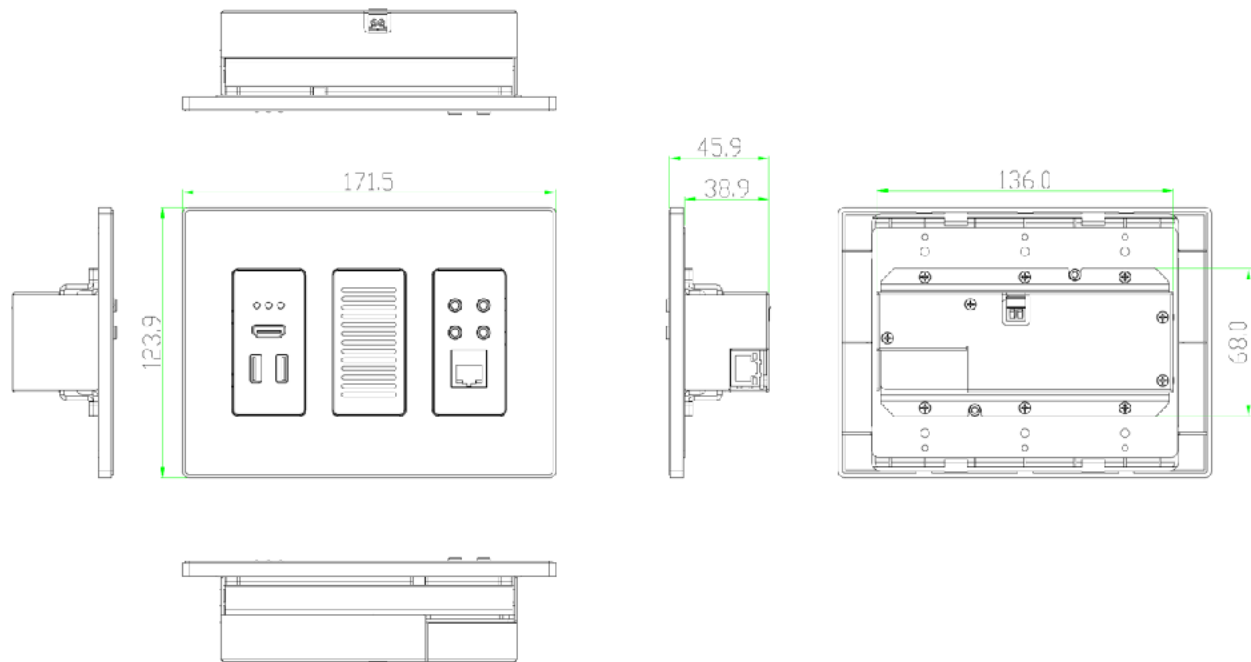

EU Wallplate (Dimensions in millimeters)

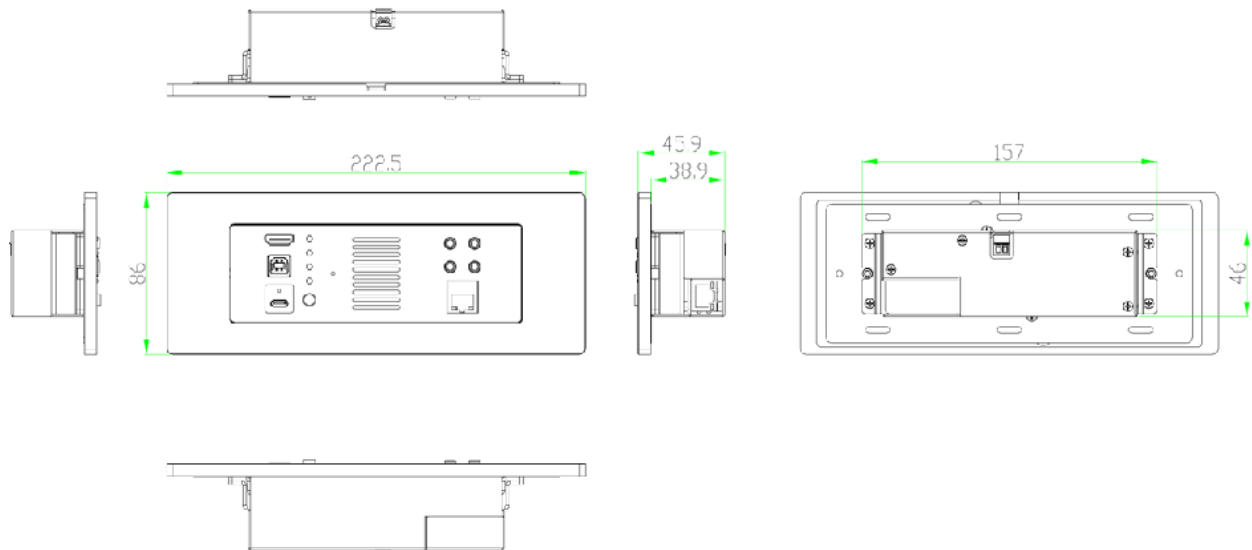

Appendix 1

Known Good USB-C Cables

The following USB-C cables have been tested with the ZyPer4K Wallplate units for simultaneous support of the following features: 3840 x 2160 video at 60Hz. Audio. USB Data for Webcam video transfer. 60W power charging. (External power supply to ZyPer4K required)

Manufacturer / Part Number	Length	Link
Kramer (Preferred solution) CA-U32/FF-10 CA-U32/FF-15	10 ft 15 ft	https://www1.kramerav.com/us/product/ca-u32/ff
BTX BTX-USB4G3CMM1M	1.0m	https://www.btx.com/usb4-g3x2-usb-c-m-m-40g-5a-240w-1m
BTX BTX-USB4CMM2M	2.0m	https://www.btx.com/usb-4-0-gen-2x2-20-gbps-240w-2-meters
Comprehensive USB10G-CC-3PROBLK	3 ft	https://comprehensiveco.com/products/pro-av-it-integrator-series-certified-ultra-flexible-10g-usb-c-to-c-male-4k-av-and-data-cable-3ft.html
Comprehensive USB10G-CC-6PROBLK	6 ft	https://comprehensiveco.com/products/pro-av-it-integrator-series-certified-ultra-flexible-10g-usb-c-to-c-male-4k-av-and-data-cable-6ft.html
Comprehensive USB10G-CC-10PROBLKA	10 ft	https://comprehensiveco.com/products/pro-av-it-integrator-series-certified-ultra-flexible-10g-usb-c-to-c-male-4k-av-and-data-cable-10ft.html
Comprehensive USB10G-CC-15PROBLKA	15 ft	https://comprehensiveco.com/products/pro-av-it-integrator-series-certified-ultra-flexible-10g-usb-c-to-usb-c-male-4k-av-and-data-cable-15ft.html
Cables to Go C2G28885 C2G28886 C2G28887	0.5m 0.8m 2.0m	https://www.cablestogo.com/usb-and-pc/usb-c-cables-adapters-and-hubs/thunderbolt-cables/6ft-2m-thunderbolt-4-usb-c-active-cable-40gbps/p/cg-c2g28887?text=28887
iVANKY VBD10	1.0m	https://www.amazon.com/Thunderbolt-Compatible-Tablets-Samsung-More-3-3ft/dp/B088627SLY?th=1
Plugable TBT3-40G80CM	0.8m	https://www.amazon.com/dp/B07R43LPCX?ref=ppx_yo2ov_dt_b_product_details&th=1

Note: ZyPer4K-XSE Encoder can support up to 100W of charging with appropriate power input and proper USB-C cables.

Appendix 2

USB-C Charging

The ZyPer4K Wallplate Encoders with USB-C input are capable of charging devices over the attached USB-C cable if the external 24V power supply is connected to the ZyPer4K Encoder.

Charging level is controlled by the attached device such as a MacBook. This ensures that the ZyPer4K is not providing more power to the connected device than is called for.

Examples:

MacBook (2016) Power supplied while “charging” = Approximately 25W
Power supplied while fully charged in sleep mode: Less than 1W

MacBook Pro (2018) Power supplied while “charging” = Approximately 53W
Power supplied while fully charged in sleep mode: Less than 1W

How seen by MacBook or MacBook Pro:

AC Charger Information:

Connected: Yes
ID: 0x0000
Wattage (W): 60
Family: 0xe000400a
Charging: Yes

Important note: The USB-C cable must be capable of carrying the required current. Low quality cables present a danger of possible cable fire. See Appendix 1 for recommended cables.

USB-C Cable Requirements

1. Cable should be as short as possible
2. Must have USB-IF certification
3. Must be USB 3.2 Gen2 (2x1 or 2x2)
4. Current rating of 5A
5. Must support USB power delivery of 100W, 20V/5A
6. Video Data specs must support 4K data at 60Hz (4K@60Hz 4:4:4)
7. Must have built in E-Mark IC

ZeeVee is not responsible for damage to any equipment caused by poor or incorrect USB-C cables.

Appendix 3

PoE Power and PoE Switches

It is important to remember that the ZyPer4K is a device that requires a 10Gb network. Therefore any PoE injector must also support 10Gb data transfer.

ZeeVee recommends the following 10G PoE Injector for use with the ZyPer4K Wallplate and ZyPer4K-XS copper units.

Procet PT-PSE104GB-60-10

To support PoE the following minimum Ethernet cable requirements must be met.

- Must be Cat6a 23AWG Solid Copper Twisted Pair.
- **Must be shielded**
- Maximum Length 328ft (100m)
- DC Loop Resistance per Pair < 25Ω
- DC Resistance Unbalance per Pair 3% or < 200mΩ

Recommended Cables:

ZeeVee has validated and can recommend Ethernet cables from Siemon Cable.

North America Link:

<https://ecatalog.siemon.com/en/Copper/Cable/Category-6A-Shielded-Cable-North-America>

International Link:

<https://ecatalog.siemon.com/en/Copper/Cable/Category-6A-Shielded-Cable-International>

Important Note

If using a Network Switch to provide PoE power to the ZyPer4K devices, it is important that the switch itself be protected against electrical surges that could be caused by something like a lightning strike. An appropriate surge protector should be placed between the Network Switch and AC power source.

Why Shielded Ethernet Cable Is Required

Shielded cable must be used with PoE systems to provide the ZyPer4K-XS or XR endpoint a path to ground when another path is not available. Shielded cable options include: F/UTP, S/UTP, F/FTP, S/FTP, SF/UTP and SF/FTP.

Unshielded Example:

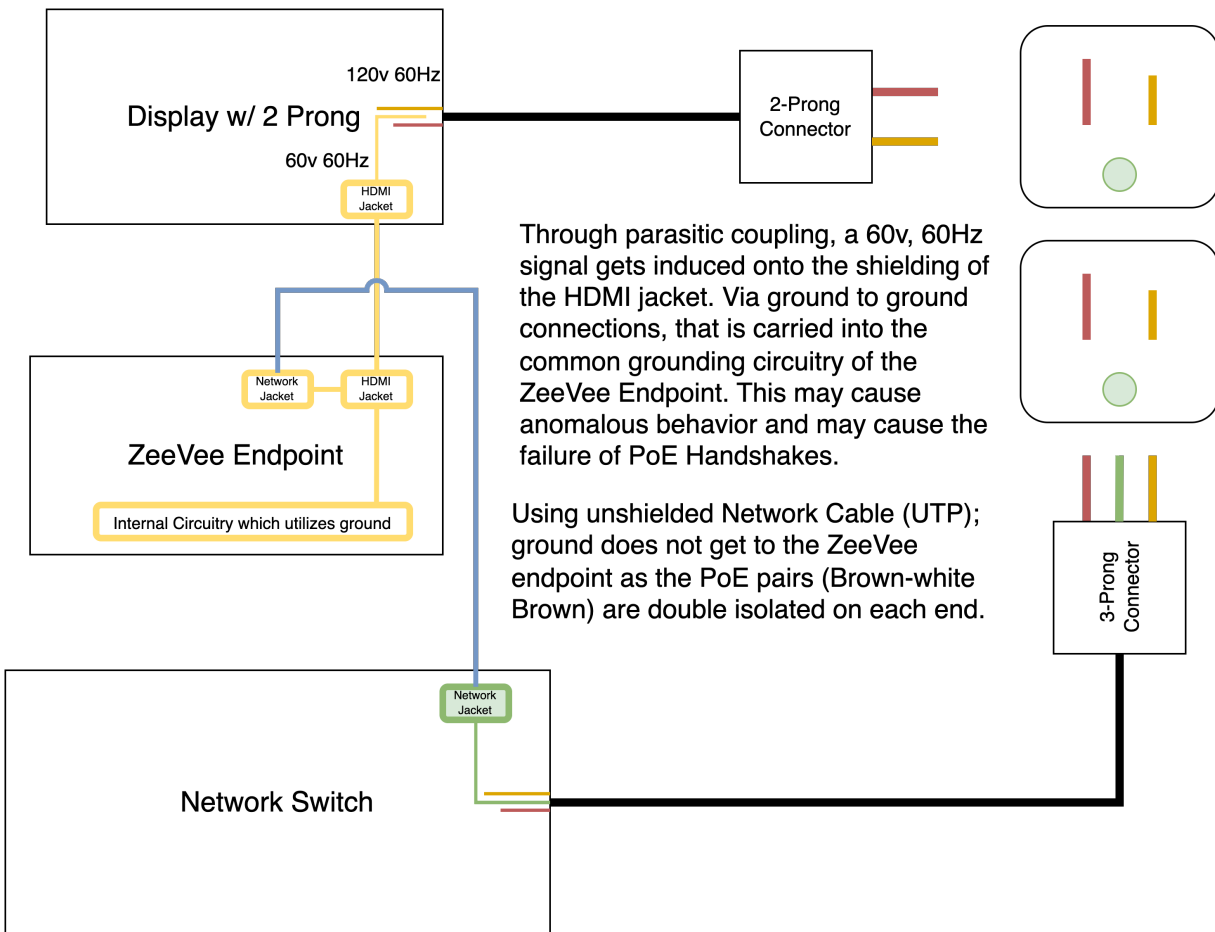

Shielded Example (F/UTP, S/UTP, F/FTP, S/FTP, SF/UTP or SF/FTP)

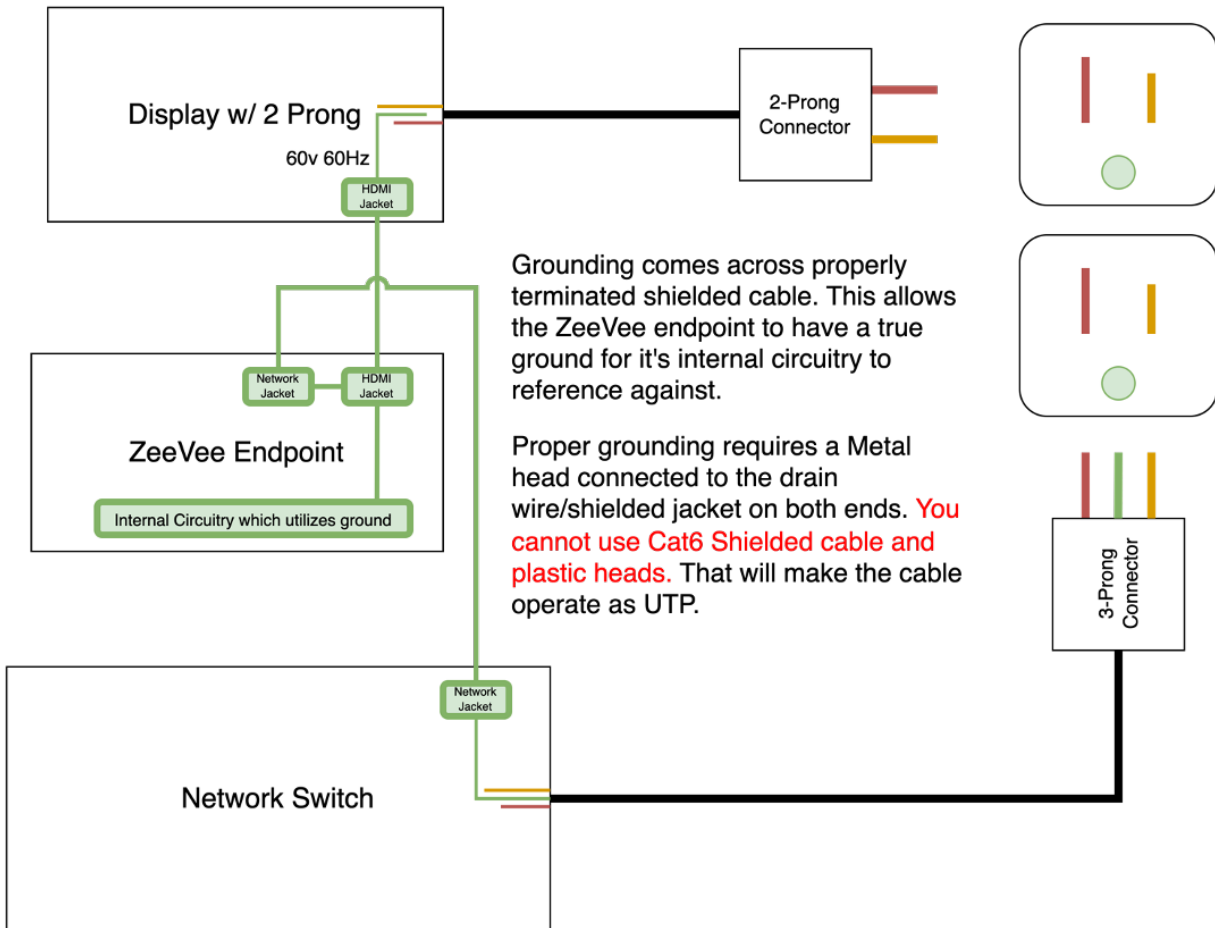

Appendix 4

Accessories

Part Number	Description
Z4KSFP10G85-3M	ZyPer4K, Fiber Optic Transceiver, SFP+ 10Gbps 850nm MMF 300m
Z4KSFP10G31-10K	ZyPer4K, Fiber Optic Transceiver, SFP+ 10Gbps 1310nm SMF 10km
Z4KIRTX	ZyPer4K Cable, IR Emitter, 10ft (Not for use with wallplate units)
Z4KIRRX	ZyPer4K Cable, IR Receiver, Dual band, 34-60KHz, 10ft (Not for use with wallplate units)
Z4KRACKC1	ZyPer4K Rack Mount Kit. Holds up to 8 ZyPer4K Encoders/Decoders in standard 5RU space. Includes rack assembly, 8 carrier units and 24 countersink screws. (Not compatible with ZyPer4K-XS units)
Z4KRACKC2	ZyPer4K Rack Mount Kit. Holds up to 8 ZyPer4K extended module Encoders/Decoders in standard 6RU space. Includes rack assembly, 8 carrier units and 24 countersink screws. (Not compatible with ZyPer4K-XS units)
Z4KPWRCTR12	ZyPer 12V Power Center for use with up to 8 ZyPer Encoder/Decoders (all models except XR). 1 RU. Includes rack ears, 8 3-foot locking 12V DC power cables, AC power cord.
Z4KBCFP	ZyPer4K Rack Mount Filler Plate Standard is used to cover unused slots in a ZyPer4K Rack Mount Kit. (Not compatible with ZyPer4K-XS units)
Z4KCExtFP	ZyPer4k Rack Mount Filler Plate Extended is used to cover unused slots in an ZyPer4K Rack Mount Kit Extended. (Not compatible with ZyPer4K-XS units)
Z4KCCBRK	ZyPer4K Rack Mount Filler Plate Center Carrier is used to cover partially unused slots that are populated with a standard ZyPer4K unit in an ZyPer4K Rack Mount Kit Extended. (Not compatible with ZyPer4K-XS units)
Z4KXSBP	ZyPer4K-XS Rack Mount Filler Plate Standard is used to cover unused slots in a ZyPer4K-XS or XSE Rack Mount Kit.
Z4KRACKXS	ZyPer4K-XS Rack Mount Kit. Holds up to 8 ZyPer4K-XS Encoders/Decoders in standard 6RU space. Includes rack assembly and 8 carrier units.
Z4KRACKXSE	ZyPer4K-XSE Rack Mount Kit. Holds up to 8 ZyPer4K-XSE Encoders/Decoders in standard 6RU space. Includes rack assembly and 8 carrier units.
Z4KVESABRK	ZyPer4K VESA Bracket is a custom wall/desk/display mount bracket for ZyPer4K. Supports standard VESA parameters for mounting directly to rear of a display. 100x100, 100x200 and 200x200 VESA hole mounts are supported. Not compatible with ZyPer4K-XR units or Extended Input Encoders.
Z4KCMNTBRKT	The ZyPer4K Wing Mount Bracket is for ZyPer4K encoders/decoders. Enables mounting to floors, ceilings, desks, walls etc. Contains 2 brackets for single encoder/decoder. Not compatible with ZyPer4K-XS/XSE or XR units.

ZyPer4K

Part Number	Description
ZWPPWR-24	ZyPer4K WP Power Supply is a 24V power supply with 2-pin phoenix connector for use with ZyPer4K Wall plate encoders and decoders. (Not for use with any other ZyPer4K product)
ZYPERPAD	ZyPerPad is a 10-button IP enabled keypad controller which provides a simple means of sending commands to the ZyPer Management Platform (ZMP). With built-in PoE, it can receive power from a PoE enabled ethernet switch. It supports individual button configuration via a simple to use web user interface.
HDMIEXT	ZeeVee HDMI Extender is a 50M HDMI and IR Extender Pair. Transmitter and Receiver. UHD@60Hz HDR Support. Includes Transmitter, Receiver, InfraRed TX/RX and two International Power supplies. Requires power on both ends. (US, UK, EU, China)
Z4K12VP	Power supply for any ZyPer4K white box encoders and decoders. Not for use with wall plates or XS/XSE//XR units. 12VDC, 36W, 3.0A, Locking DC Jack, Power cable not included.
Z4K12VP-XS	Power supply for any ZyPer4K XS/XSE units. 12VDC, 4.2A Power cable not included.

Appendix 5

ZyPer4K Part Numbers

Part Number	Description
Z4KENCF3	ZyPer4K HDMI 2.0 input Encoder, with IP streaming via 10Gbit/fiber. Supports analog audio, IR, RS-232. No USB. Includes power supply. Requires ZyPer4K Decoder. Cables not included.
Z4KENCF3U	ZyPer4K HDMI 2.0 input Encoder, with IP streaming via 10Gbit/fiber. Supports USB, analog audio, IR, RS-232. Includes power supply. Requires ZyPer4K Decoder. Cables not included.
Z4KDECF3	ZyPer4K HDMI 2.0 output Decoder, accepts IP streaming via 10Gbit/fiber. Supports analog audio, IR, RS-232. No USB. Includes power supply. Requires ZyPer4K Encoder. Cables not included.
Z4KDECF3U	ZyPer4K HDMI 2.0 output Decoder, accepts IP streaming via 10Gbit/fiber. Supports USB, analog audio, IR, RS-232. Includes power supply. Requires ZyPer4K Encoder. Cables not included.
Z4KDPDECF3	ZyPer4K HDMI 2.0 output and DisplayPort Decoder, accepts IP streaming via 10Gbit/fiber. Supports analog audio, IR, RS-232. No USB. Includes power supply. Requires ZyPer4K Encoder. Cables not included.
Z4KDPDECF3U	ZyPer4K HDMI 2.0 output and DisplayPort Decoder, accepts IP streaming via 10Gbit/fiber. Supports USB, analog audio, IR, RS-232. Includes power supply. Requires ZyPer4K Encoder. Cables not included.
Z4K12GSDIENCF3	ZyPer4K Extended Module, HDMI 2.0 and 12G SDI input Encoder, with IP streaming via 10Gbit/fiber. Supports analog audio, IR, RS-232. No USB. Includes power supply. Requires ZyPer4K Decoder. Cables not included. Available 09/01/2023.
Z4K12GSDIENCF3U	ZyPer4K Extended Module, HDMI 2.0 and 12G SDI input Encoder, with IP streaming via 10Gbit/fiber. Supports USB, analog audio, IR, RS-232. Includes power supply. Requires ZyPer4K Decoder. Cables not included. Available 09/01/2023.
Z4KDPENCF3	ZyPer4K Extended Module, HDMI 2.0 and Display Port input Encoder, with IP streaming via 10Gbit/fiber. Supports analog audio, IR, RS-232. No USB. Includes power supply. Requires ZyPer4K Decoder. Cables not included.
Z4KDPENCF3U	ZyPer4K Extended Module, HDMI 2.0 and Display Port input Encoder, with IP streaming via 10Gbit/fiber. Supports USB, analog audio, IR, RS-232. Includes power supply. Requires ZyPer4K Decoder. Cables not included.
Z4KANLENCF3	ZyPer4K Extended Module, HDMI 2.0 and analog video (component, composite, VGA, S-video) input Encoder, with IP streaming via 10Gbit/fiber. Supports analog audio, IR, RS-232. No USB. Includes power supply. Requires ZyPer4K Decoder. Cables not included.

ZyPer4K

Part Number	Description
Z4KANLENCF3U	ZyPer4K Extended Module, HDMI 2.0 and analog video (component, composite, VGA, S-video) input Encoder, with IP streaming via 10Gbit/fiber. Supports USB, analog audio, IR, RS-232. Includes power supply. Requires ZyPer4K Decoder. Cables not included.
Z4KHDMIENC3	ZyPer4K Extended Module, Dual HDMI 2.0 input Encoder with single HDMI loop-out, with IP streaming via 10Gbit/fiber. Supports analog audio, IR, RS-232. Includes power supply and wall mount brackets. Requires ZyPer4K Decoder. Cables not included.
Z4KHDMIENC3U	ZyPer4K Extended Module, Dual HDMI 2.0 input Encoder with single HDMI loop-out, with IP streaming via 10Gbit/fiber. Supports USB, analog audio, IR, RS-232. Includes power supply and wall mount brackets. Requires ZyPer4K Decoder. Cables not included.
Z4KDF3UA Discontinued	ZyPer4K HDMI 2.0 output Decoder with Dante Transmitter, accepts IP streaming via 10Gbit/fiber. Supports USB, IR, RS-232. Includes power supply. Requires ZyPer4K Encoder. Cables not included.
Z4KENCF3XS	ZyPer4K-XS HDMI 2.0 input Encoder, with IP streaming via 10Gbit/fiber. Supports HDMI and analog audio input. USB supported with between ZyPer4K XS/XR devices. Includes power supply. Compatible with any ZyPer4K Decoder. Cables not included.
Z4KDECF3XS	ZyPer4K-XS HDMI 2.0 output Decoder, accepts IP streaming via 10Gbit/fiber. Supports HDMI and analog audio output. USB supported with between ZyPer4K XS/XR devices. Includes power supply. Compatible with any ZyPer4K Encoder. Cables not included.
Z4KENCFSXR Discontinued	ZyPer4K-XR HDMI 2.0 input Encoder with IP streaming via 10Gbit/Fiber. 850nm Multi-Mode Fiber Media Port. Supports HDMI and Analog audio Input. USB supported with between ZyPer4K XS/XR devices. Compatible with any ZyPer4K Decoder. AC power port, 1GB utility port and M10 Truss Clamp mounting hole. Enclosure and all connectors are rugged.
Z4KENCFLXR Discontinued	ZyPer4K-XR HDMI 2.0 input Encoder with IP streaming via 10Gbit/Fiber. 1300nm Single-Mode Fiber Media Port. Supports HDMI and Analog audio Input. USB supported with between ZyPer4K XS/XR devices. Compatible with any ZyPer4K Decoder. AC power port, 1GB utility port and M10 Truss Clamp mounting hole. Enclosure and all connectors are rugged.
Z4KDECF3XR Discontinued	ZyPer4K-XR HDMI 2.0 output Decoder, accepts IP streaming via 10Gbit/fiber. 850nm Multi-Mode Fiber Media Port. Supports HDMI and Analog audio Input. USB supported with between ZyPer4K XS/XR devices. Compatible with any ZyPer4K Encoder. AC power port, 1GB utility port and M10 Truss Clamp mounting hole. Enclosure and all connectors are rugged.
Z4KDECF3XR Discontinued	ZyPer4K-XR HDMI 2.0 output Decoder, accepts IP streaming via 10Gbit/fiber. 1300nm Single-Mode Fiber Media Port. Supports HDMI and Analog audio Input. USB supported with between ZyPer4K XS/XR devices. Compatible with any ZyPer4K Encoder. AC power port, 1GB utility port and M10 Truss Clamp mounting hole. Enclosure and all connectors are rugged.

ZyPer4K

Part Number	Description
Z4KENCC3	ZyPer4K HDMI 2.0 input Encoder, with IP streaming via 10Gbit/copper. Supports analog audio, IR, RS-232. No USB. Includes power supply. Requires ZyPer4K Decoder. Cables not included.
Z4KENCC3U	ZyPer4K HDMI 2.0 input Encoder, with IP streaming via 10Gbit/copper. Support USB, analog audio, IR, RS-232. Includes power supply. Requires ZyPer4K Decoder. Cables not included.
Z4KDECC3	ZyPer4K HDMI 2.0 output Decoder, accepts IP streaming via 10Gbit/copper. Supports analog audio, IR, RS-232. No USB. Includes power supply. Requires ZyPer4K Encoder. Cables not included.
Z4KDECC3U	ZyPer4K HDMI 2.0 output Decoder, accepts IP streaming via 10Gbit/copper. Supports USB, analog audio, IR, RS-232. Includes power supply. Requires ZyPer4K Encoder. Cables not included.
Z4KDPDECC3	ZyPer4K HDMI 2.0 output and DisplayPort Decoder, accepts IP streaming via 10Gbit/copper. Supports analog audio, IR, RS-232. No USB. Includes power supply. Requires ZyPer4K Encoder. Cables not included.
Z4KDPDECC3U	ZyPer4K HDMI 2.0 output and DisplayPort Decoder, accepts IP streaming via 10Gbit/copper. Supports USB, analog audio, IR, RS-232. Includes power supply. Requires ZyPer4K Encoder. Cables not included.
Z4K12GSDIENCC3	ZyPer4K Extended Module, HDMI 2.0 and 12G SDI input Encoder, with IP streaming via 10Gbit/copper. Supports analog audio, IR, RS-232. No USB. Includes power supply. Requires ZyPer4K Decoder. Cables not included. Available 09/01/2023.
Z4K12GSDIENCC3U	ZyPer4K Extended Module, HDMI 2.0 and 12G SDI input Encoder, with IP streaming via 10Gbit/copper. Supports USB, analog audio, IR, RS-232. Includes power supply. Requires ZyPer4K Decoder. Cables not included. Available 09/01/2023.
Z4KDPENCC3	ZyPer4K Extended Module, HDMI 2.0 and Display Port input Encoder, with IP streaming via 10Gbit/copper. Supports analog audio, IR, RS-232. No USB. Includes power supply. Requires ZyPer4K Decoder. Cables not included.
Z4KDPENCC3U	ZyPer4K Extended Module, HDMI 2.0 and Display Port input Encoder, with IP streaming via 10Gbit/copper. Supports USB, analog audio, IR, RS-232. Includes power supply. Requires ZyPer4K Decoder. Cables not included.
Z4KANLENCC3 Discontinued	ZyPer4K Extended module, HDMI 2.0 and analog video (component, composite, VGA, S-video) input Encoder, with IP streaming via 10Gbit/copper. Supports analog audio, IR, RS-232. No USB. Includes power supply. Requires ZyPer4K Decoder. Cables not included.
Z4KANLENCC3U Discontinued	ZyPer4K Extended Module, HDMI 2.0 and analog video (component, composite, VGA, S-video) input Encoder, with IP streaming via 10Gbit/copper. Supports USB, analog audio, IR, RS-232. Includes power supply. Requires ZyPer4K Decoder. Cables not included.

ZyPer4K

Part Number	Description
Z4KHDMIENCC3	ZyPer4K Extended Module, Dual HDMI 2.0 input Encoder with single HDMI loop-out, with IP streaming via 10Gbit/copper. Supports analog audio, IR, RS-232. Includes power supply. Requires ZyPer4K Decoder. Cables not included.
Z4KHDMIENCC3U	ZyPer4K Extended Module, Dual HDMI 2.0 input Encoder with single HDMI loop-out, with IP streaming via 10Gbit/copper. Supports USB, analog audio, IR, RS-232. Includes power supply. Requires ZyPer4K Decoder. Cables not included.
Z4KDC3UA Discontinued	ZyPer4K HDMI 2.0 output Decoder with Dante Transmitter accepts IP streaming via 10Gbit/copper. Supports USB, IR, RS-232. Includes power supply. Requires ZyPer4K Encoder. Cables not included.
Z4KENCC3XS	ZyPer4K-XS HDMI 2.0 input Encoder, with IP streaming via 10Gbit/copper. PoE. Supports HDMI and analog audio input. USB supported with mini USB-B port between ZyPer4K XS/XR devices. Includes power supply. Compatible with any ZyPer4K Decoder. Cables not included.
Z4KDECC3XS	ZyPer4K-XS HDMI 2.0 output Decoder, accepts IP streaming via 10Gbit/copper. PoE. Supports HDMI and analog audio output. USB supported with between ZyPer4K XS/XR devices. Includes power supply. Compatible with any ZyPer4K Encoder. Cables not included.
Z4KENCC3XR Discontinued	ZyPer4K-XR HDMI 2.0 input Encoder with IP streaming via 10Gbit/copper. PoE. Supports HDMI and Analog audio Input. USB supported with between ZyPer4K XS/XR devices. Compatible with any ZyPer4K Decoder. AC power port, 1GB utility port and M10 Truss Clamp mounting hole. Enclosure and all connectors are rugged.
Z4KDECC3XR Discontinued	ZyPer4K-XR HDMI 2.0 output Decoder, accepts IP streaming via 10Gbit/Copper. PoE. Supports HDMI and Analog audio Input. USB supported with between ZyPer4K XS/XR devices. Compatible with any ZyPer4K Encoder. AC power port, 1GB utility port and M10 Truss Clamp mounting hole. Enclosure and all connectors are rugged.
Z4KENCC3XS-WPUS	ZyPer4K-XS HDMI 2.0 and USB-C input Wallplate Encoder (US Form factor), with IP streaming via 10Gbit/copper. PoE. Supports analog audio, IR, RS-232. USB supported with between ZyPer4K XS/XR devices. Audio/Video compatible with any ZyPer4K Decoder. Power supply not included.
Z4KDECC3XS-WPUS	ZyPer4K-XS HDMI 2.0 Wallplate Decoder (US Form factor), with IP streaming via 10Gbit/copper. PoE. Supports analog audio, IR, RS-232. USB supported between ZyPer4K XS/XR devices. Audio/Video compatible with any ZyPer4K Encoder. Power supply not included.
Z4KDECC3XS-WPUS-I	ZyPer4K-XS HDMI 2.0 Wallplate Decoder (US Form factor), with IP streaming via 10Gbit/copper. PoE. Supports analog audio, IR, RS-232. Icron USB supported between ZyPer4K Classic devices. Audio/Video compatible with any ZyPer4K Encoder. Power supply not included.

ZyPer4K

Part Number	Description
Z4KENCC3XS-WPUS-I	ZyPer4K-XS HDMI 2.0 and USB-C input Wallplate Encoder (US Form factor), with IP streaming via 10Gbit/copper. PoE. Supports analog audio, IR, RS-232. Icron USB supported between ZyPer4K Classic devices. Audio/Video compatible with any ZyPer4K Decoder. Power supply not included.
Z4KC2XS-E	ZyPer4K-XSE Encoder, with IP streaming via 10Gbit/copper. PoE. Supports HDMI 2.0 and USB-C Video Inputs, HDMI Loop-out and balanced analog audio in/out (via 5-pin phoenix). USB HID support via USB-C port. Includes power supply. Audio/Video compatible with any ZyPer4K Decoder. Cables not included.
Z4KC2XS-EAU	ZyPer4K-XSE Encoder, with IP streaming via 10Gbit/copper with Dante support. PoE. Supports HDMI 2.0 and USB-C Video Inputs, HDMI Loop-out and balanced analog audio in/out (via 5-pin phoenix). Full USB 2.0 via Icron chipset on USB-C port. Includes power supply. Audio/Video compatible with any ZyPer4K Decoder. Cables not included.
Z4KF2XS-E	ZyPer4K-XSE Encoder, with IP streaming via 10Gbit/fiber. Supports HDMI 2.0 and USB-C Video Inputs, HDMI Loop-out and balanced analog audio in/out (via 5-pin phoenix). USB HID support via USB-C port. Includes power supply. Audio/Video compatible with any ZyPer4K Decoder. Cables not included.
Z4KF2XS-EAU	ZyPer4K-XSE Encoder, with IP streaming via 10Gbit/fiber with Dante support. Supports HDMI 2.0 and USB-C Video Inputs, HDMI Loop-out and balanced analog audio in/out (via 5-pin phoenix). Full USB 2.0 via Icron chipset on USB-C port. Includes power supply. Audio/Video compatible with any ZyPer4K Decoder. Cables not included.
Z4KCXS-D	ZyPer4K-XSE Decoder, accepts IP streaming via 10Gbit/copper. PoE. Supports HDMI 2.0 and balanced analog audio output (via 5-pin phoenix). USB HID support via USB-A port. RS232 via 3-pin phoenix connector. Includes power supply. Audio/Video compatible with any ZyPer4K Encoder. Cables not included
Z4KCXS-DAU	ZyPer4K-XSE Decoder, accepts IP streaming via 10Gbit/copper with Dante support. PoE. Supports HDMI 2.0 and balanced analog audio output (via 5-pin phoenix). Full USB 2.0 support via Icron chipset on USB-A port. RS232 via 3-pin phoenix connector. Includes power supply. Audio/Video compatible with any ZyPer4K Encoder. Cables not included
Z4KFXS-D	ZyPer4K-XSE Decoder, accepts IP streaming via 10Gbit/fiber. Supports HDMI 2.0 and balanced analog audio output (via 5-pin phoenix). USB HID support via USB-A port. RS232 via 3-pin phoenix connector. Includes power supply. Audio/Video compatible with any ZyPer4K Encoder. Cables not included
Z4KFXS-DAU	ZyPer4K-XSE Decoder, accepts IP streaming via 10Gbit/fiber with Dante support. Supports HDMI 2.0 and balanced analog audio output (via 5-pin phoenix). Full USB 2.0 support via Icron chipset on USB-A port. RS232 via 3-pin phoenix connector. Includes power supply. Audio/Video compatible with any ZyPer4K Encoder. Cables not included

ZyPer4K

Part Number	Description
Z4KC2XS-D	ZyPer4K-XSE Decoder, accepts IP streaming via 10Gbit/copper. PoE. Supports HDMI 2.0 and balanced analog audio output (via 5-pin phoenix). USB HID support via Dual USB-A ports. RS232 via 3-pin phoenix connector. Includes power supply. Audio/Video compatible with any ZyPer4K Encoder. Cables not included
Z4KC2XS-DAU	ZyPer4K-XSE Decoder, accepts IP streaming via 10Gbit/copper with Dante support. PoE. Supports HDMI 2.0 and balanced analog audio output (via 5-pin phoenix). Full USB 2.0 support via Icron chipset on Dual USB-A ports. RS232 via 3-pin phoenix connector. Includes power supply. Audio/Video compatible with any ZyPer4K Encoder. Cables not included
Z4KF2XS-D	ZyPer4K-XSE Decoder, accepts IP streaming via 10Gbit/fiber. Supports HDMI 2.0 and balanced analog audio output (via 5-pin phoenix). USB HID support via Dual USB-A ports. RS232 via 3-pin phoenix connector. Includes power supply. Audio/Video compatible with any ZyPer4K Encoder. Cables not included
Z4KF2XS-DAU	ZyPer4K-XSE Decoder, accepts IP streaming via 10Gbit/fiber with Dante support. Supports HDMI 2.0 and balanced analog audio output (via 5-pin phoenix). Full USB 2.0 support via Icron chipset on Dual USB-A ports. RS232 via 3-pin phoenix connector. Includes power supply. Audio/Video compatible with any ZyPer4K Encoder. Cables not included

Disclaimers

Kramer has striven to ensure that this document is accurate and represents the described products fully. Although, ZeeVee assumes no responsibility for errors found, should any be found, please contact zv_support@kramerav.com and corrections will be issued as appropriate.

Kramer hardware designs are property of Kramer.

Components, sub-assemblies, and methods utilized in the designs are free of any encumbrances or appropriate licenses and rights have been obtained by ZeeVee for the use in the described products in the intended manner.

Kramer software is the sole property of Kramer except within the restrictions and guidelines of any open-source or public-license component utilized. Kramer represents that normal usage of the product in a typical customer installation is fully within the granted rights and privileges of any licensed component. Visit www.zeevee.com or www.kramerav.com for further details.

The specifications of the described products may change at any time without notice.

Kramer forbids unauthorized disassembly, reverse-engineering, duplication, or any other attempt to recreate all or portions of the hardware or software outside of any use explicitly authorized in writing by Kramer.

Trademarks

All trademarks are the property of their respective owners.

Copyright

This document is copyrighted with all rights reserved. This document or any portion contained may not be reproduced or copied by any means - graphically, mechanically, or electronically - without express written authorization of ZeeVee.

© 2017 ZeeVee, Inc. All rights reserved.

© 2024 Kramer, Inc. All rights reserved.



TAA Compliance

All ZyPer4K units are TAA Compliant with the exception of the Wallplate units.