

# HDMI 150m Extender With Loopout

Model: E150CL

VER 1.0

User Manual

## Thank you for purchasing this product

For optimum performance and safety, please read these instructions carefully before connecting, operating or adjusting this product. Please keep this manual for future reference.

## Surge protection device recommended

This product contains sensitive electrical components that may be damaged by electrical spikes, surges, electric shock, lightning strikes, etc. Use of surge protection systems is highly recommended in order to protect and extend the life of your equipment.

## Table of Contents

<b>1. Introduction .....</b>	<b>4</b>
<b>2. Features .....</b>	<b>4</b>
<b>3. Package Contents .....</b>	<b>5</b>
<b>4. Specifications .....</b>	<b>5</b>
<b>5. Operation Controls and Functions .....</b>	<b>7</b>
<b>6. Connection Diagram .....</b>	<b>11</b>

## Caution

The extender must follow direct interconnection method CAT cable.

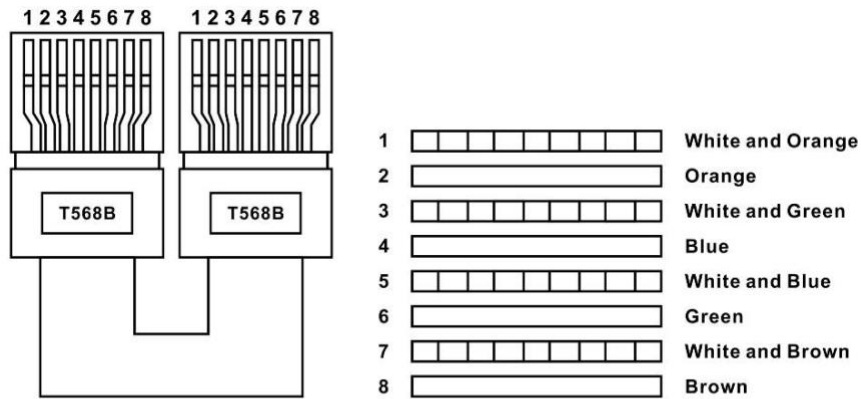

### Direct interconnection method

The extender will go into protection mode automatically and no video out when using cross interconnection method CAT cable.

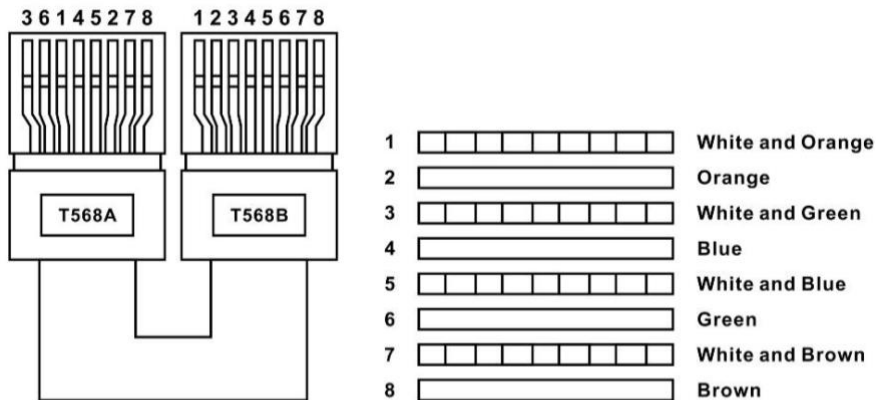

### Cross interconnection method

## 1. Introduction

The HDMI Extender with Loopout can extend HDMI signal over 500 feet/150 meters to an HDMI compatible display via single Cat5e/6 cable. It also supports bi-directional Infrared control signal and RS-232 transmission together with HDMI signal, it allows you to easily control your DVD player at TV side or control your TV at the DVD player side when using this extender.

## 2. Features

- HDMI 1.4, HDCP 1.4 and DVI compliant
- Video resolutions up to 1080p@60Hz (YUV4:4:4)
- HDMI High Bit Rate(HBR) audio pass through
- 150 meters transmission distance over CAT6 cable
- POC (Power over Cable), either TX or RX is powered by one 24V@1A power supply
  - ✘ See the description 1
- Bi-directional infrared control signal transmission
  - ✘ See the description 2
- Bi-directional RS-232 signal transmission
  - ✘ See the description 3

## 3. Package Contents

- 1 x HDMI Extender Transmitter
- 1 x HDMI Extender Receiver
- 1 x Wideband IR Emitter cable
- 1 x Wideband IR Receiver cable

- 1 x 24V/1A Power Adaptor
- 1 x User Manual

## 4. Specifications

Technical	
<b>HDMI Compliance</b>	HDMI 1.4
<b>HDCP Compliance</b>	HDCP 1.4
<b>Video Bandwidth</b>	225MHz
<b>Video Resolutions</b>	up to 1080P @60Hz YUV4:4:4, RGB4:4:4
<b>Color Space</b>	RGB, YUV4:4:4, YUV 4:2:2
<b>Color Depth</b>	8-bit
<b>HDMI Audio Formats (Pass-through)</b>	LPCM 2/5.1/7.1CH, Dolby Digital, DTS 5.1, Dolby Digital+, Dolby True HD, DTS-HD Master Audio, Dolby Atmos, DTS:X
<b>ESD Protection</b>	Human body model — ±8kV (air-gap discharge) & ±4kV (contact discharge)
Connections	
<b>Inputs</b>	<p>Transmitter : 1x HDMI Type A [19-pin female]</p> <p style="padding-left: 40px;">1x IR INPUT [3.5mm Stereo Mini-jack]</p> <p style="padding-left: 40px;">1x RS232 [Phoenix jack]</p> <p>Receiver: 1x HDBaseT In [RJ45]</p> <p style="padding-left: 40px;">1x IR INPUT [3.5mm Stereo Mini-jack]</p> <p style="padding-left: 40px;">1x RS232 [Phoenix jack]</p>
<b>Outputs</b>	<p>Transmitter : 1x HDBaseT Out [RJ45]</p> <p style="padding-left: 40px;">1x HDMI Type A [19-pin female]</p> <p style="padding-left: 40px;">1x IR OUTPUT [3.5mm Stereo Mini-jack]</p> <p>Receiver: 1x HDMI Type A [19-pin female]</p> <p style="padding-left: 40px;">1x IR OUTPUT [3.5mm Stereo Mini-jack]</p>
Mechanical	
<b>Housing</b>	Metal Enclosure
<b>Color</b>	Black
<b>Dimensions</b>	140mm [W] x 65mm [D] x 18mm [H]
<b>Weight</b>	481g
<b>Power Supply</b>	Input: AC100 - 240V 50/60Hz Output: DC 24V/1A (US/EU standards, CE/FCC/UL certified)

<b>Power Consumption</b>	6W
<b>Operation Temperature</b>	32 - 104°F / 0 - 40°C
<b>Storage temperature</b>	-4 - 140°F / -20 - 60°C
<b>Relative Humidity</b>	20 - 90% RH (no condensation)

## 5. Operation Controls and Functions

### 5.1 Transmitter

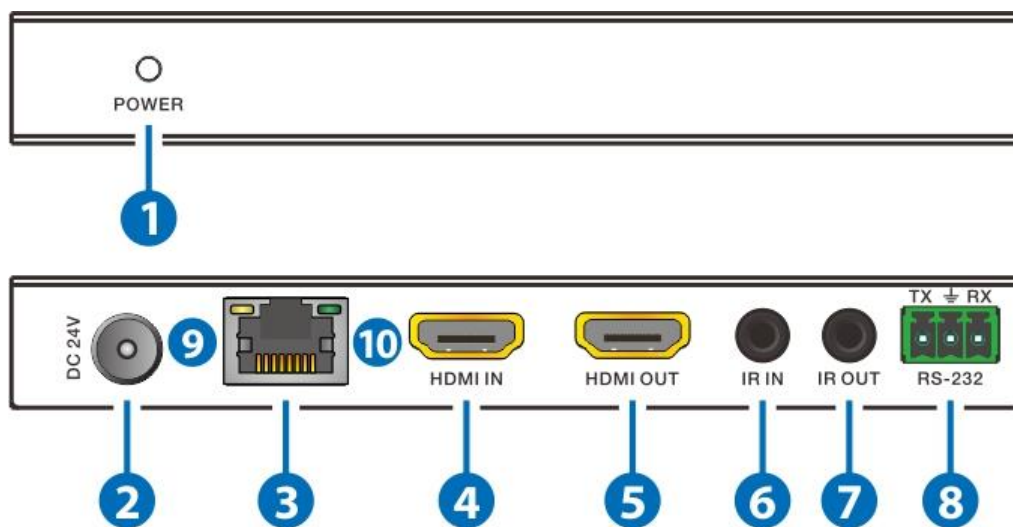

- 1** **Power:** System power indicator.
- 2** **DC 24V:** Connect 24V/1A adaptor to AC wall outlet for power supply.
- 3** **HDBaseT Out:** Standard HDBaseT output port. Connect HDBaseT receiver with a UTP cable following the standard of direct interconnection method.
- 4** **HDMI In:** Connect to HDMI source device such as Blu-ray or PS4 player.
- 5** **HDMI OUT:** Connect to HDTV or monitor HDMI input port.
- 6** **IR In:** Channel 2 IR Receiver. Connect to an IR receiver cable.
- 7** **IR Out:** Channel 1 IR Transmitter. Connect to an IR emitter cable.
- 8** **RS-232:** Phoenix jack provide serial port control from transmitter to

receiver.

### 8 Connection Signal Indicator Lamp

※Illuminate: The Transmitter and Receiver are in good connections status.

※Flashing: The Transmitter and Receiver are in poor connections status.

※Dark: The Transmitter and Receiver are not connected.

### 9 Data Signal Indicator Lamp

※Illuminate: HDMI signal with HDCP.

※Flashing: HDMI signal without HDCP.

※Dark: No HDMI signal.

## 5.2 Receiver

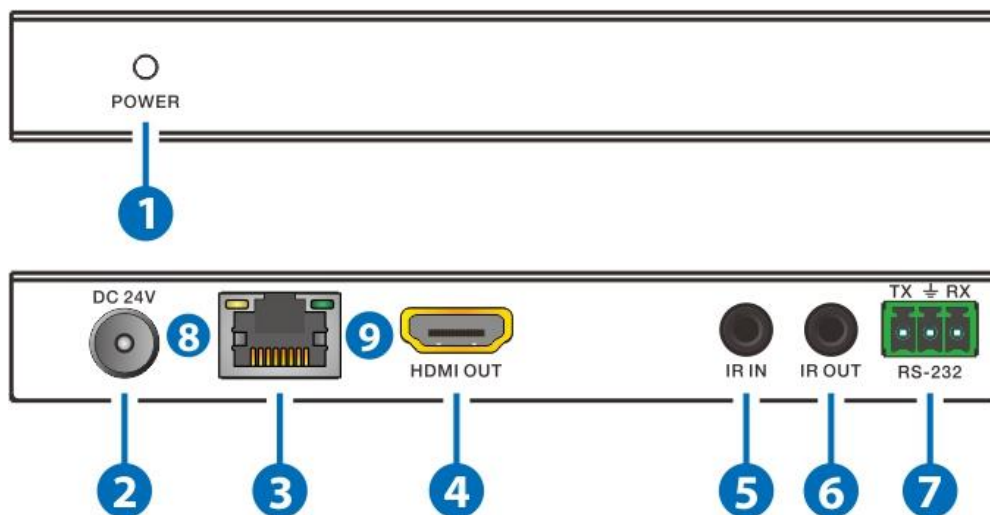

- 1** Power: System power indicator.
- 2** DC 24V: Connect 24V/1A adaptor to AC wall outlet for power supply.
- 3** HDBaseT In: Standard HDBaseT input port. Connect HDBaseT Transmitter with a UTP cable following the standard of direct

interconnection method.

- 4 **HDMI Out:** Connect to the HDTV or monitor HDMI input port.
- 5 **IR In:** Channel 1 IR Receiver. Connect to an IR receiver cable.
- 6 **IR Out:** Channel 2 IR Transmitter. Connect to an IR emitter cable.
- 7 **RS-232:** Phoenix jack provide Serial port control signal from transmitter to receiver.

#### 8 **Connection Signal Indicator Lamp**

※Illuminate: The Transmitter and Receiver are in good connections status.

※Flashing: The Transmitter and Receiver are in poor connections status.

※Dark: The Transmitter and Receiver are not connected.

#### 9 **Data Signal Indicator Lamp**

※Illuminate: HDMI signal with HDCP.

※Flashing: HDMI signal without HDCP.

※Dark: No HDMI signal.

#### ※ Description 1

POC (Power over Cable) Application Example



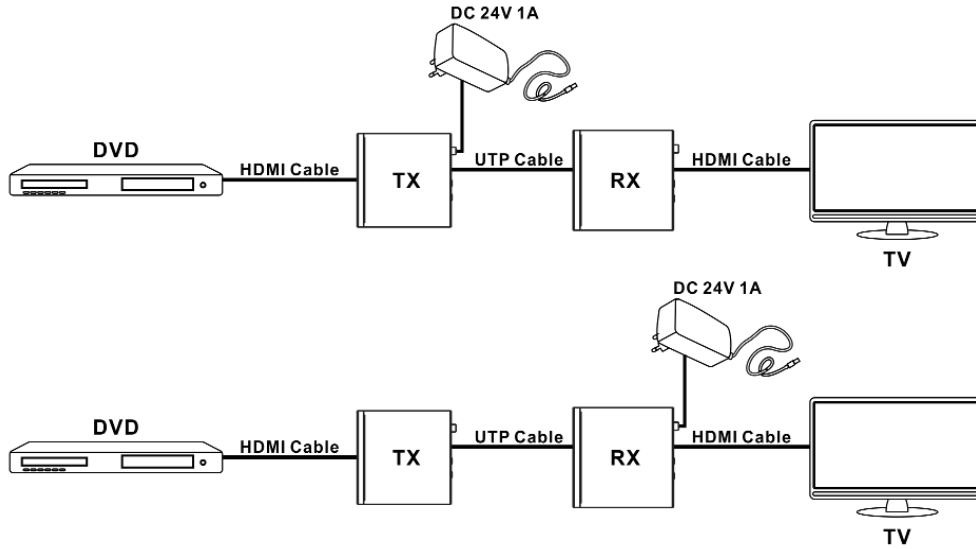

※ Description 2

Bidirectional Infrared control Application Example

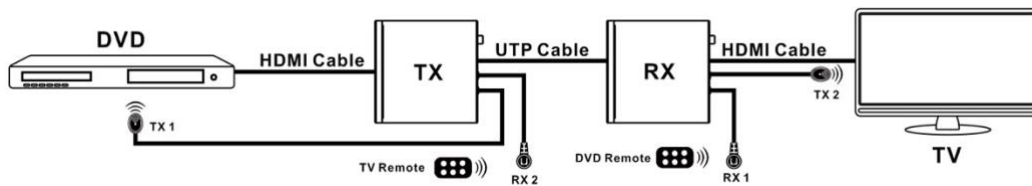

※ Description 3

Bidirectional RS232 control Application Example

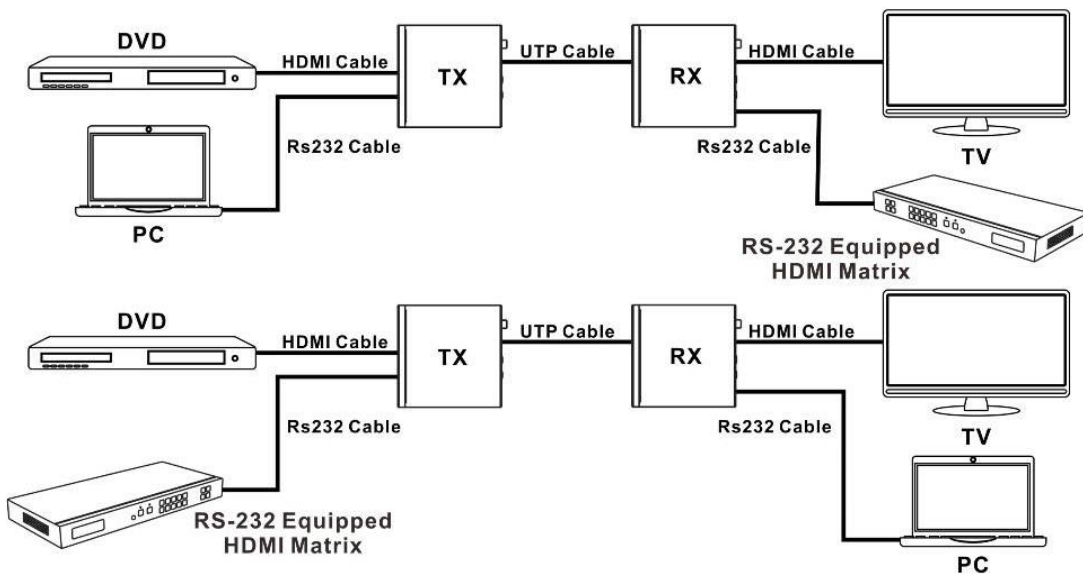

## 6. Connection Diagram

