

# SWITCH

Best-in-class switches and matrices for sending sources to single or multiple destinations

Supporting mission-critical AV installations world-wide.  
We Engineer Confidence.



**tvONE**<sup>®</sup>

We Engineer Confidence

## tvONE switcher product development timeline

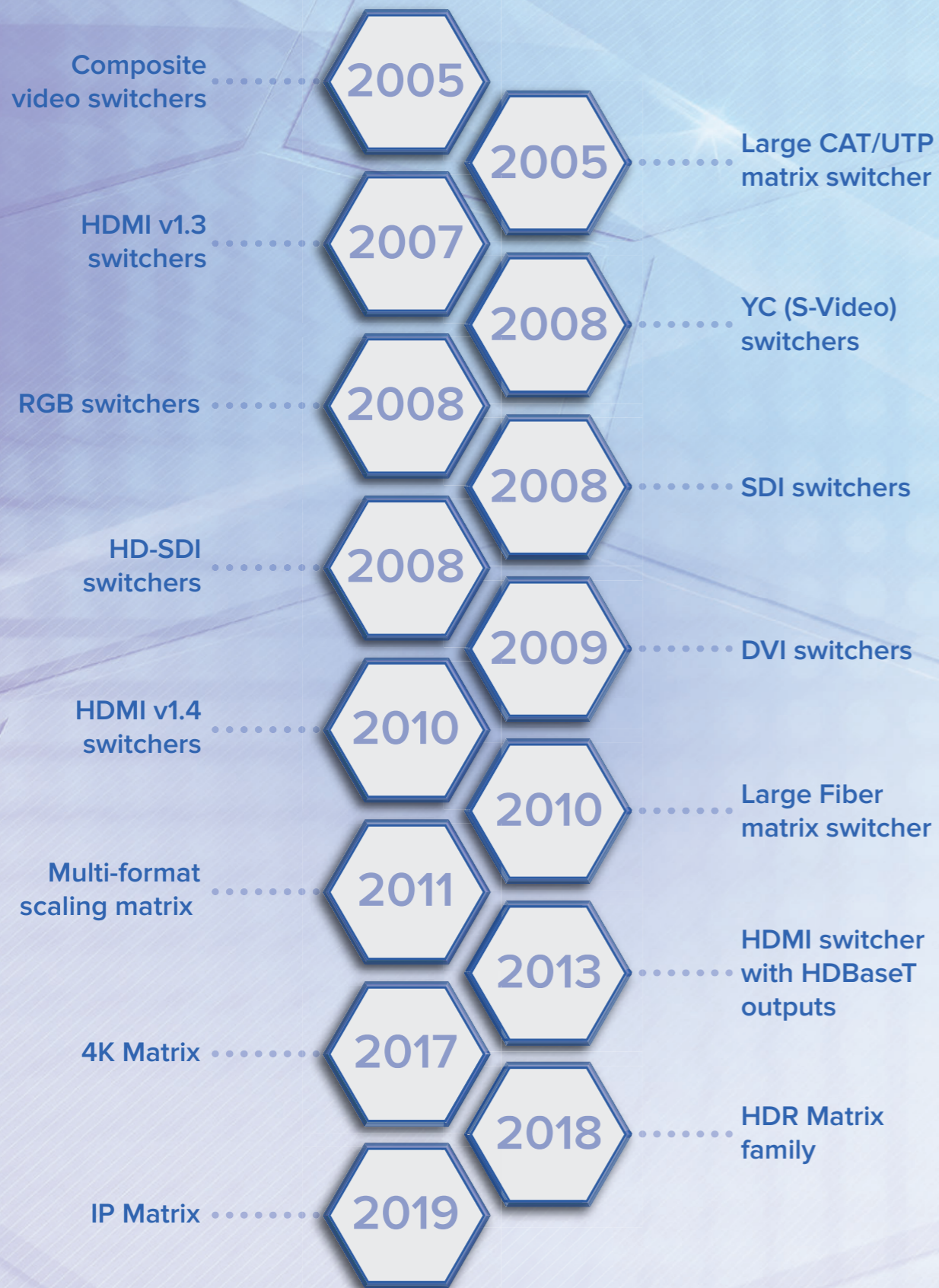

## The tvONE difference:

Are you suffering from heart-stopping "AV moments"? Then step up to tvONE's leading range of ultra-reliable switchers and matrices that feature award winning performance as standard. Choose from our range of solutions for every need and every budget. From entry level products, to advanced systems, tvONE provides easy integration of the most popular inputs and outputs, together with solutions that can expand up to thousands of end points.

### Switcher selection guide:

Experience our AV, Broadcast and IP solutions with rich feature sets including format conversion, scaling and extension.

**Cable type** – tvONE has the widest range of input and output types. All our solutions are designed, manufactured and tested for real-world environments where interoperability and clean, synchronous switching are key while still maintaining low latency and high image quality.



**Size** – tvONE solutions include switches (single output) and matrices (multiple outputs) in a variety of sizes.

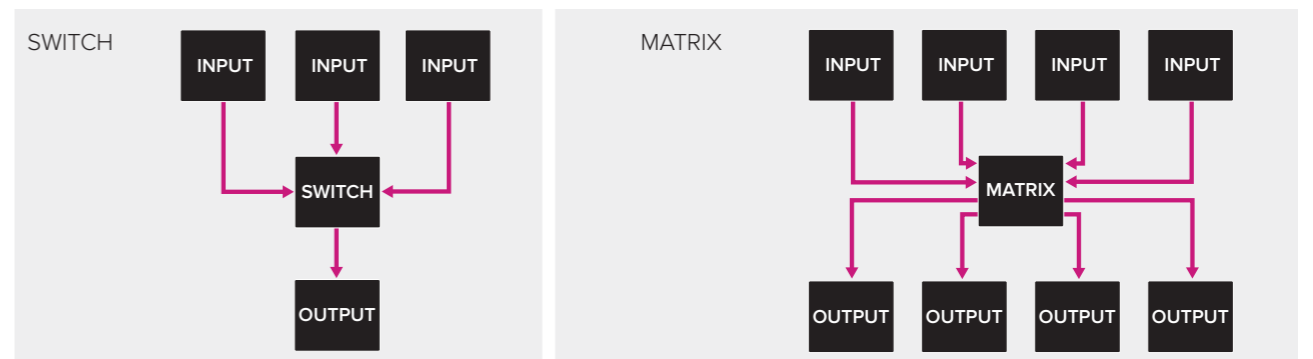

**Features** – Choose from the widest range of features for the perfect installation.

|                                                                                                                                                               |                                                                                                                                                         |                                                                                                                                                       |                                                                                                                                   |
|---------------------------------------------------------------------------------------------------------------------------------------------------------------|---------------------------------------------------------------------------------------------------------------------------------------------------------|-------------------------------------------------------------------------------------------------------------------------------------------------------|-----------------------------------------------------------------------------------------------------------------------------------|
| <p><b>Format conversion</b></p> <p>Mix and match your content and simplify your installs by making your format, aspect and output resolutions independent</p> | <p><b>Scaling</b></p> <p>It's easy to mix and match your content whatever the source or format, using our high quality, low latency scaling engine.</p> | <p><b>Modularity</b></p> <p>Build the system you need with our modular building block approach on our CORIOmatrix, MultiView and Voyager family's</p> | <p><b>Auto switching</b></p> <p>Save time, eliminate system complexity and control headaches with automatic source switching.</p> |
|---------------------------------------------------------------------------------------------------------------------------------------------------------------|---------------------------------------------------------------------------------------------------------------------------------------------------------|-------------------------------------------------------------------------------------------------------------------------------------------------------|-----------------------------------------------------------------------------------------------------------------------------------|

**Control** – tvONE solutions offer a range of options to allow users to easily control their matrix and switcher solutions. Choose from front panels, control software and web browsers, on screen display (OSD) and infra-red control options. You can also integrate our CORIO based solutions to popular AV control solutions simply and easily using our free to download plug-ins.



## Small Switchers & Matrices - up to 8x8

Connect and present in seconds with our compact solutions with fast switching, wide format support and easy control. tvONE guarantees glitch-free switching between a variety of computer and other signal types to a single output for corporate, medical, government, hospitality and control rooms.

**MX-6544**



**MX-6588**



HDMI 2.0 is the new standard for switching 4K/60 video where you need life-like, deep color rendition. The MX-65xx matrix switcher series provides guaranteed HDMI 2.0 performance and allows you to switch multiple sources to multiple display devices independently or at the same time.

**1T-SX-654**



**MX-8488**



**MX-5288**

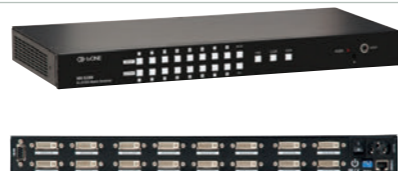

A range of small switches are available in a number of fit-for-purpose designs. tvONE guarantees high-performance routing of HDMI, DVI and HDBaseT signals. Full bandwidth processing, easy EDID management and a variety of control options ensures ultra-reliable operation and peace of mind for integrators and end users.

### Compatible tvONE products



## Small matrix application

### Corporate Boardroom

4K solution for your small presentation suite. Combine multiple sources up to HDMI 2.0 for life-like detail and color.

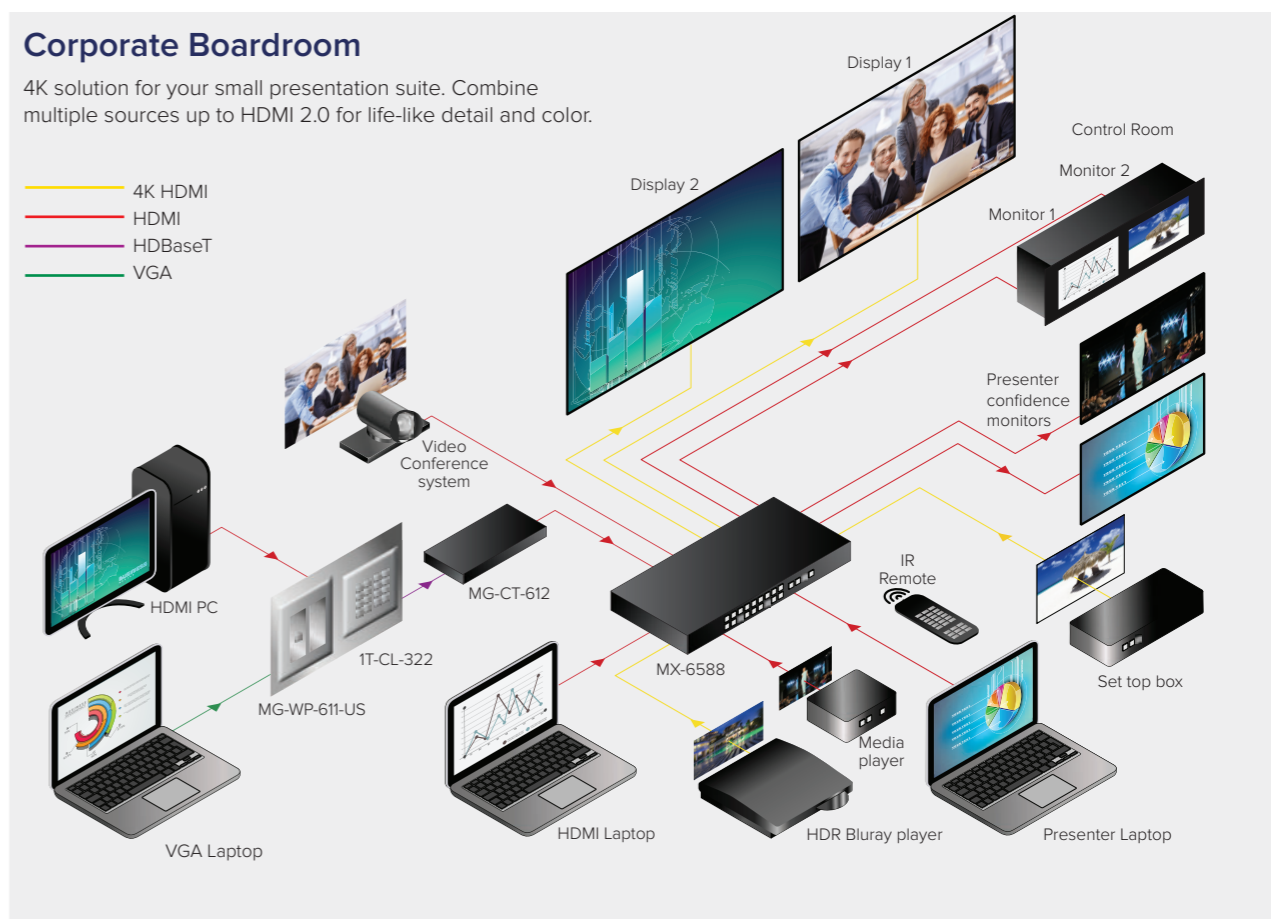
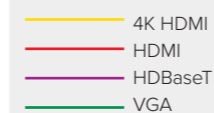

## Small switch application

### Hotel Ballroom

Quickly convert your room from a wedding to corporate presentation with our HDMI 2.0 auto-switcher.

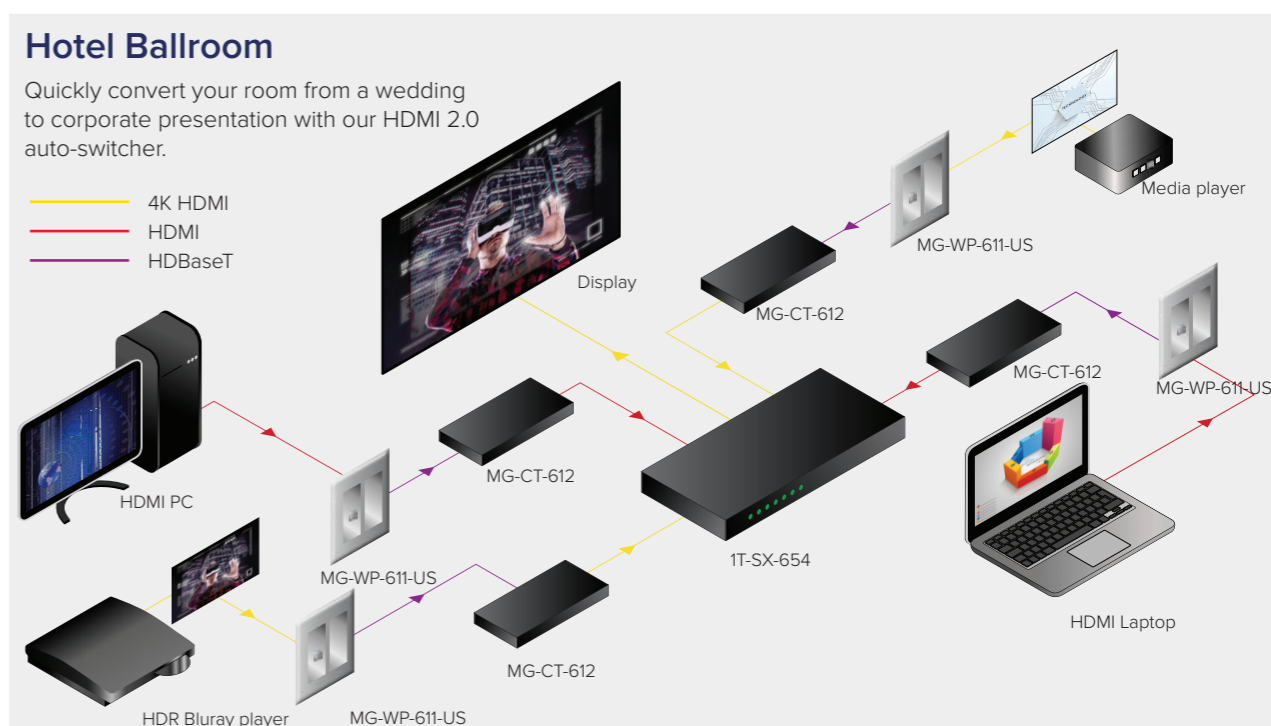
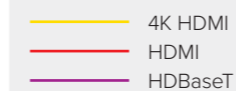



The EU assembly in Belgium counts on many CORIOmatrixes signal conversion abilities, every day

## Medium Matrices - up to 60 inputs or 24 outputs

The CORIOmatrix series is the ultimate 4K modular AV matrix with scaling, format conversion and extension capabilities built in as standard. The versatility and adaptability provided by the CORIOmatrix modular design helps integrators overcome the wide-ranging challenges of BYOD.



## Compatible tvONE products



## Installation examples:

### Medical

Operating Rooms demand high-resolution video with ultra-low latency performance.

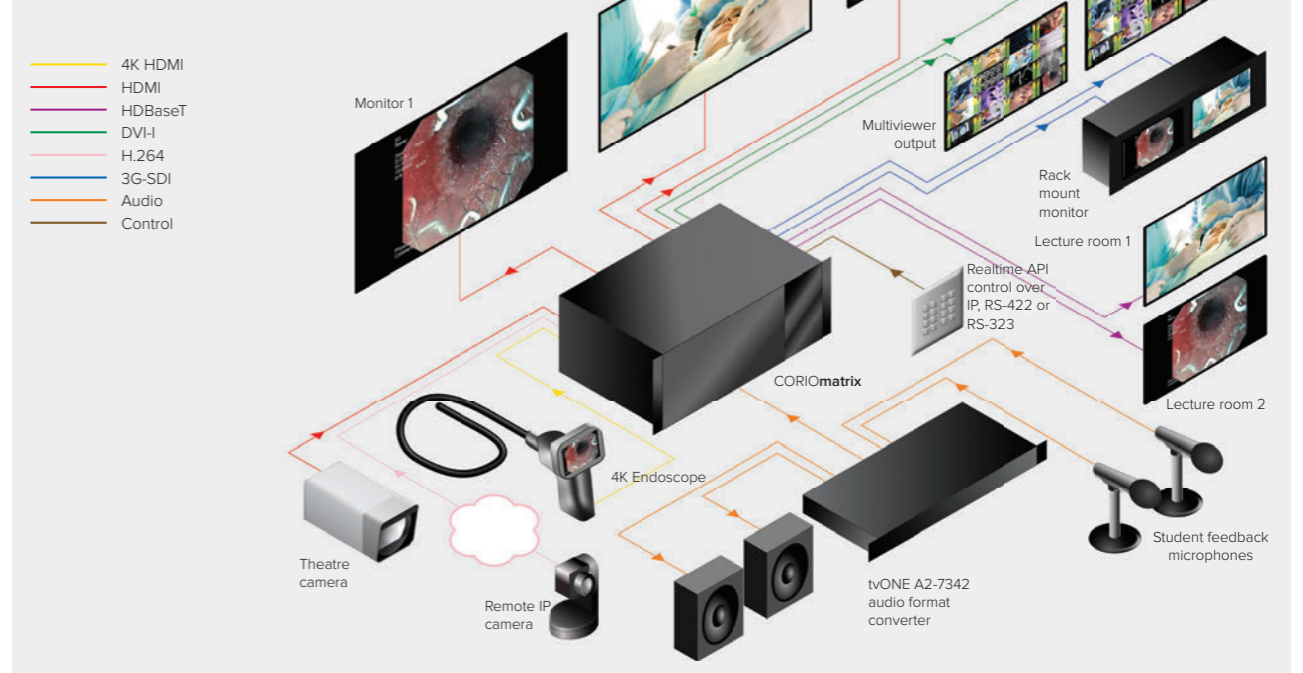

### Custom and OEM Products

If your company has a unique application or requires somewhat different features than are available in our standard scan converter or video scaler models, we are experienced in providing custom products. tvONE has developed custom solutions for a large number of clients, for both high and modest quantity requirements. Past projects have ranged from providing minor software modifications to an existing model to designing and manufacturing completely new products for the mass market.

### Events

Boost your performance or presentation. Multi-format inputs, low latency and LED wall compatibility will captivate your audience

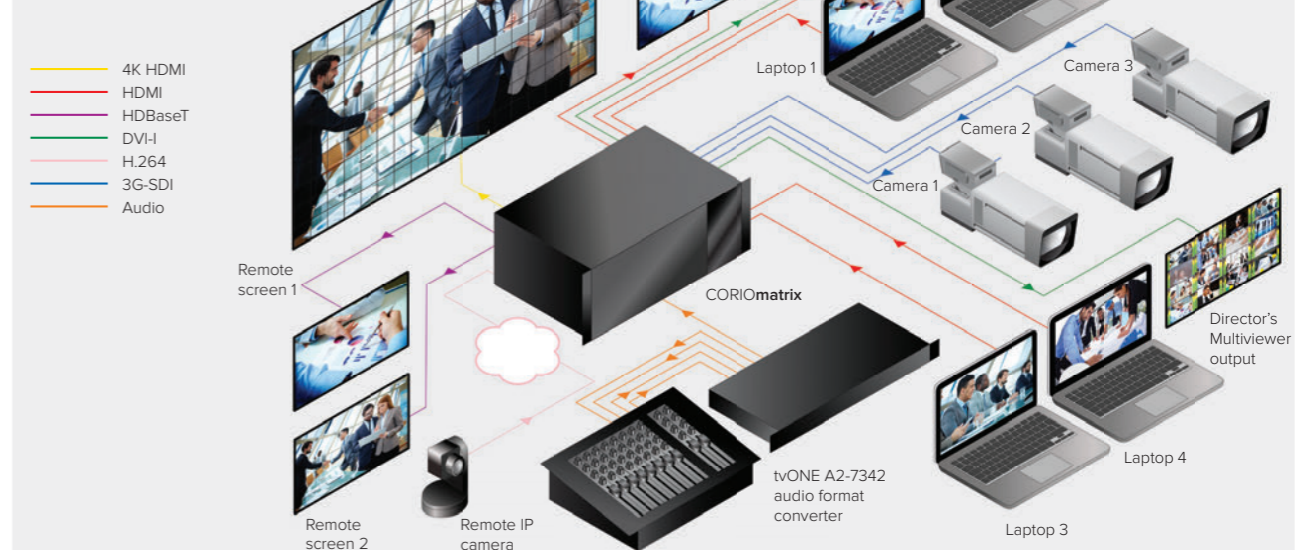



Casino's all over the world have been relying on the Magenta Mondo Matrix to provide long distance, matrixed video for years



New York Stock Exchange relies on Voyager Fiber 24/7

## Large CAT Matrices – up to 256x512

The Mondo is the benchmark for AV switching over UTP and is available in many configurations ranging from 16x16 up to 256x512. It's the proven core of many mission critical installation world-wide that deliver flexible switching and long-distance extension of video, audio and control signals.

Simply add MultiView end points for an ultra-flexible building block approach and easily adapt to any installation footprint with guaranteed performance up to 1200 feet (365m).



## Medical college with Mondo

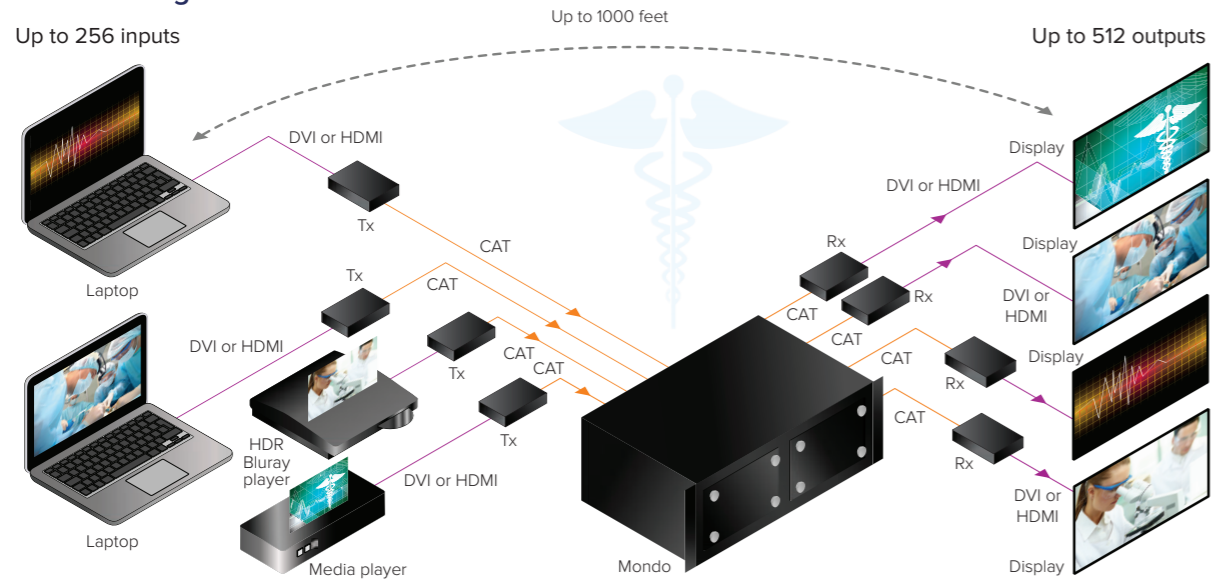

## Large Fiber Matrices – 1000+ ports

Voyager is a high-performance system using fiber for short or long-haul transport of uncompressed 1080p/60 video. Options include single-mode (up to 18.75 miles / 30 Kilometers) and multi-mode (up to 6,600 feet / 2 Kilometers).

The VG-Matrix series is the beating heart of large deployments of up to 2,000 end points. The modular and scalable full cross point matrix switching platform is field configurable in increments of eight inputs and/or outputs up to 160x160 and beyond.

Simply add interoperable modular or compact form end points to your matrix for a limitless variety of end-to-end configurations for the distribution of uncompressed video, audio and RS-232 control signals.

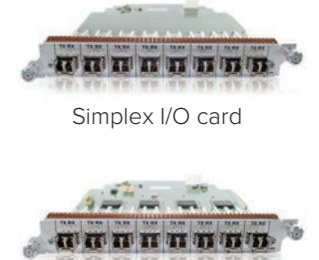
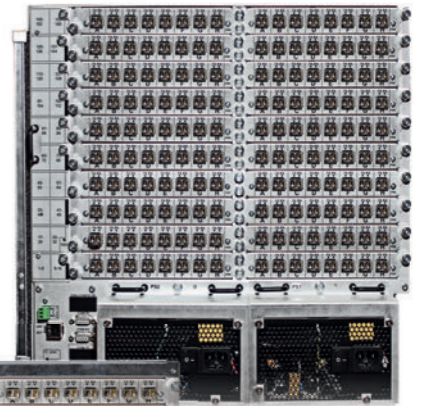

Simplex I/O card



Duplex I/O card

## Compatible MultiView products



## Compatible Voyager products



## Product Summary

| Small HDMI 2.0 Switchers & Matrices - up to 8x8 | Size | Inputs |     |        |        |    | Outputs |     |        |        |         | Resolution |       |    |        | Advanced Features |                |                   |       |                        |
|-------------------------------------------------|------|--------|-----|--------|--------|----|---------|-----|--------|--------|---------|------------|-------|----|--------|-------------------|----------------|-------------------|-------|------------------------|
|                                                 |      | HDMI   | DVI | 3G SDI | Analog | IP | HDMI    | DVI | 3G SDI | Analog | HDBaseT | SD         | 1080p | 4K | Custom | Scaling           | Fast Switching | Signal conversion | Audio | Additional Features*** |
| MX-6544                                         | 4x4  | ✓      |     |        |        |    | ✓       |     |        |        |         |            | ✓     |    |        |                   |                | ✓                 |       |                        |
| MX-6584                                         | 8x4  | ✓      |     |        |        |    | ✓       |     |        |        |         |            | ✓     |    |        |                   |                | ✓                 |       |                        |
| MX-6588                                         | 8x8  | ✓      |     |        |        |    | ✓       |     |        |        |         |            | ✓     |    |        |                   |                | ✓                 |       |                        |
| 1T-SX-654                                       | 4x1  | ✓      |     |        |        |    | ✓       |     |        |        |         |            | ✓     |    |        |                   |                | ✓                 |       |                        |

| Other Small Switchers & Matrices - up to 8x8 | Size | Inputs |     |        |        |    | Outputs |     |        |        |         | Resolution |       |    |        | Advanced Features |                |                   |       |                        |
|----------------------------------------------|------|--------|-----|--------|--------|----|---------|-----|--------|--------|---------|------------|-------|----|--------|-------------------|----------------|-------------------|-------|------------------------|
|                                              |      | HDMI   | DVI | 3G SDI | Analog | IP | HDMI    | DVI | 3G SDI | Analog | HDBaseT | SD         | 1080p | 4K | Custom | Scaling           | Fast Switching | Signal conversion | Audio | Additional Features*** |
| MX-8488                                      | 8x8  | ✓      |     |        |        |    |         |     |        | ✓      |         | ✓          |       |    |        |                   |                |                   |       |                        |
| MX-5288                                      | 8x8  |        | ✓   |        |        |    |         | ✓   |        |        |         | ✓          |       |    |        |                   |                |                   |       |                        |
| 1T-MX-6344                                   | 4x4  | ✓      |     |        |        |    | ✓       |     |        |        |         | ✓          |       |    |        |                   |                |                   |       |                        |
| 1T-SX-644                                    | 4x1  | ✓      |     |        |        |    | ✓       |     |        |        |         | ✓          |       |    |        | ✓                 |                |                   |       |                        |
| 1T-SX-632                                    | 2x1  | ✓      |     |        |        |    | ✓       |     |        |        |         | ✓          |       |    |        |                   |                |                   |       |                        |
| 1T-C2-750                                    | 2x1  |        | ✓   |        |        |    |         | ✓   |        |        |         | ✓          |       |    | ✓      | ✓                 | ✓              | ✓                 |       | ✓                      |
| MX-3141PCA                                   | 4x1  |        |     |        | ✓      |    |         |     |        | ✓      |         | ✓          | ✓     |    |        |                   |                |                   |       |                        |
| MX-3141CSVA                                  | 4x1  |        |     |        | ✓      |    |         |     |        | ✓      |         | ✓          |       |    |        |                   | ✓              |                   |       |                        |
| AVT-6071                                     | 8x1  | ✓      |     |        | ✓      |    | ✓       |     |        |        |         | ✓          | ✓     |    |        |                   | ✓              |                   |       |                        |
| C2-8000                                      | 12x2 |        | ✓   |        |        |    |         | ✓   |        |        |         |            | ✓     |    | ✓      | ✓                 | ✓              | ✓                 |       | ✓                      |
| C2-2855                                      | 6x1  | ✓      | ✓   | ✓      | ✓      | ✓  | ✓       | ✓   | ✓      | ✓      |         | ✓          | ✓     |    | ✓      | ✓                 | ✓              | ✓                 |       | ✓                      |

| Medium Matrices - up to 60 inputs or 24 outputs | Size    | Inputs |     |        |        |    | Outputs |     |        |        |         | Resolution |       |    |        | Advanced Features |                |                   |       |                        |
|-------------------------------------------------|---------|--------|-----|--------|--------|----|---------|-----|--------|--------|---------|------------|-------|----|--------|-------------------|----------------|-------------------|-------|------------------------|
|                                                 |         | HDMI   | DVI | 3G SDI | Analog | IP | HDMI    | DVI | 3G SDI | Analog | HDBaseT | SD         | 1080p | 4K | Custom | Scaling           | Fast Switching | Signal conversion | Audio | Additional Features*** |
| CORIOmatrix                                     | 60*x24* | ✓      | ✓   | ✓      | ✓      | ✓  | ✓       | ✓   | ✓      | ✓      | ✓       | ✓          | ✓     | ✓  | ✓      | ✓                 | ✓              | ✓                 | ✓     | ✓                      |
| CORIOmatrix mini                                | 18*x10* | ✓      | ✓   | ✓      | ✓      | ✓  | ✓       | ✓   | ✓      | ✓      | ✓       | ✓          | ✓     | ✓  | ✓      | ✓                 | ✓              | ✓                 | ✓     | ✓                      |

| Large CAT Matrices - up to 265x512 | Size    | Inputs |     |        |        |    | Outputs |     |        |        |         | Resolution |       |    |        | Advanced Features |                |                   |       |                        |
|------------------------------------|---------|--------|-----|--------|--------|----|---------|-----|--------|--------|---------|------------|-------|----|--------|-------------------|----------------|-------------------|-------|------------------------|
|                                    |         | HDMI   | DVI | 3G SDI | Analog | IP | HDMI    | DVI | 3G SDI | Analog | HDBaseT | SD         | 1080p | 4K | Custom | Scaling           | Fast Switching | Signal conversion | Audio | Additional Features*** |
| Mondo                              | 256x512 |        | ✓   |        | ✓      |    |         | ✓   |        | ✓      |         | ✓          | ✓     |    |        |                   | ✓              |                   |       |                        |

| Large Fiber Matrices - 1,000+ ports | Size      | Inputs |     |        |        |    | Outputs |     |        |        |         | Resolution |       |    |        | Advanced Features |                |                   |       |                        |
|-------------------------------------|-----------|--------|-----|--------|--------|----|---------|-----|--------|--------|---------|------------|-------|----|--------|-------------------|----------------|-------------------|-------|------------------------|
|                                     |           | HDMI   | DVI | 3G SDI | Analog | IP | HDMI    | DVI | 3G SDI | Analog | HDBaseT | SD         | 1080p | 4K | Custom | Scaling           | Fast Switching | Signal conversion | Audio | Additional Features*** |
| Voyager matrix                      | 500x500** | ✓      |     |        | ✓      |    | ✓       |     |        |        |         | ✓          | ✓     |    |        | ✓                 | ✓              | ✓                 |       |                        |

\* Modular matrices, this is max inputs or max outputs

\*\*Voyager Matrix does not require equal number of inputs and outputs

\*\*\* Advanced features include windowing, logo insertion,

# EXTEND



# SWITCH



# DISTRIBUTE

**HDMI 2.0 and DisplayPort 1.4 extension - up to 328ft**

Active Optical Cable Series  
32-328 feet



MG-AOC-66x 4K60 HDMI 2.0 extension  
MG-AOC-88x 8K60 DisplayPort 1.4 extension

**Point-to-point HDBaseT extension up to 500ft**

LX500 → 500ft  
DX500  
DX → 328ft

**HDBaseT wallplate and compact receiver**



MG-WP-61t: HDBaseT wallplate with HDMI, VGA and audio inputs  
MG-CT-612: Compact form HDBaseT Receiver

**HDMI 2.0 Matrix Switchers**

MX-6588 4K60 8x8 HDMI 2.0 Matrix  
MX-6544 4K60 4x4 HDMI 2.0 Matrix

**Ultra-compact HDMI 2.0 Switcher**

1T-SX-654 4K60 4x1 HDMI 2.0 Switcher

**4K Universal Scaling Matrix Router**



CORIOmatrix C3-340

**4K Universal Scaling Matrix Router**



CORIOmatrix mini C3-310

**HDMI 2.0 Distribution**

1T-DA-682 4K60 1x2 Splitter  
1T-DA-684 4K60 1x4 Distribution Amplifier  
1T-DA-688 4K60 1x8 Distribution Amplifier

**Ultra-slim form factor**

MG-DA-612 4K60 1x2 Splitter  
MG-DA-614 4K60 1x4 Distribution Amplifier  
MG-DA-618 4K60 1x8 Distribution Amplifier

**HDMI & DVI Distribution**

1T-DA-672 1x2 HDMI Splitter  
1T-DA-674 1x4 HDMI Distribution Amplifier  
1T-DA-678 1x8 HDMI Distribution Amplifier  
1T-DA-554 1x4 DVI Distribution Amplifier  
1T-DA-552 1x2 DVI Splitter

**Magenta MultiView**  
Ultra-robust CAT6 matrix switching to 512 end points and distribution from 1 source to 729 displays

**Point-to-Point CAT Extension - up to 1000ft**

DVI/HDMI Transmitter  
CAT to 1000ft  
DVI/HDMI Receiver

**CAT Matrix Switcher**

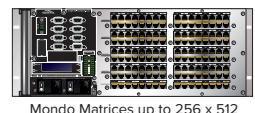

Mondo Matrices up to 256 x 512

**CAT Distribution**

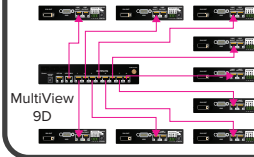

MultiView 9D

**Magenta Voyager**  
Dependable fiber distribution and matrix switching to 2000+ end points

**Fiber point-to-point extension - up to 18.75 miles**

Compact Form Transmitter  
Fiber 18.75 miles  
Modular Transmitter  
Compact Form Transmitter

**Fiber Optic Matrix Switcher**



Fiber Matrices up to 320 ports  
Also available in a 48 port version.

**Fiber Optic Distribution**

Compact Form Transmitter  
4-Port Receiver

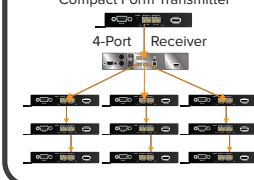

Toll Free: +44 (0)1628 566830

sales.europe@tvone.com

www.tvone.com