



CPRO-U4H1HFS

UHD 4 to 1 HDMI Switcher



Operation Manual



DISCLAIMERS

The information in this manual has been carefully checked and is believed to be accurate. Cypress Technology assumes no responsibility for any infringements of patents or other rights of third parties which may result from its use.

Cypress Technology assumes no responsibility for any inaccuracies that may be contained in this document. Cypress also makes no commitment to update or to keep current the information contained in this document.

Cypress Technology reserves the right to make improvements to this document and/or product at any time and without notice.

COPYRIGHT NOTICE

No part of this document may be reproduced, transmitted, transcribed, stored in a retrieval system, or any of its part translated into any language or computer file, in any form or by any means—electronic, mechanical, magnetic, optical, chemical, manual, or otherwise—without express written permission and consent from Cypress Technology.

© Copyright 2014 by Cypress Technology.

All Rights Reserved.

Version 1.0 May 2014

TRADEMARK ACKNOWLEDGMENTS

All products or service names mentioned in this document may be trademarks of the companies with which they are associated.



SAFETY PRECAUTIONS

Please read all instructions before attempting to unpack, install or operate this equipment and before connecting the power supply.

Please keep the following in mind as you unpack and install this equipment:

- Always follow basic safety precautions to reduce the risk of fire, electrical shock and injury to persons.
- To prevent fire or shock hazard, do not expose the unit to rain, moisture or install this product near water.
- Never spill liquid of any kind on or into this product.
- Never push an object of any kind into this product through any openings or empty slots in the unit, as you may damage parts inside the unit.
- Do not attach the power supply cabling to building surfaces.
- Use only the supplied power supply unit (PSU). Do not use the PSU if it is damaged.
- Do not allow anything to rest on the power cabling or allow any weight to be placed upon it or any person walk on it.
- To protect the unit from overheating, do not block any vents or openings in the unit housing that provide ventilation and allow for sufficient space for air to circulate around the unit.

REVISION HISTORY

VERSION NO.	DATE DD/MM/YY	SUMMARY OF CHANGE
VR0	25/03/15	Preliminary Release

CONTENTS

1. Introduction.....	1
2. Applications.....	1
3. Package Contents	1
4. System Requirements.....	1
5. Features.....	2
6. Operation Controls and Functions.....	3
6.1 Front Panel.....	3
6.2 Rear Panel.....	4
6.3 Remote Control.....	5
6.4 RS-232 Pin Assignment	5
6.5 IP Searching Software Application and Installation.....	6
6.6 RS-232 & Telnet Commands.....	7
6.7 EDID Content	9
6.8 Telnet Control	10
6.9 WebGUI Control.....	12
7. Connection Diagram	14
8. Specifications	15
9. Acronyms	17



1. INTRODUCTION

The 4 by 1 HDMI Switcher enables the switching of four HDMI sources to a single HDMI output, allowing a display or AV Receiver to select between four devices. With fast switching technology the device can greatly eliminate the time required by swapping or turning ON/OFF the connected displays. It supports 4K2K, 3D, 36-bit Deep Color, Hi-Def. lossless audio and other features defined by the latest HDMI specifications. The management of source/sink scenarios can be operated easily through on-panel buttons, IR remote control, RS-232, Telnet and WebGUI control.

2. APPLICATIONS

- Home Theater/Entertainment
- Lecture Room/Hall Presentation
- Show Room/Demo Room
- Public Commercial Display
- Information Board

3. PACKAGE CONTENTS

- UHD 4 to 1 HDMI Switcher
- Remote Control with Battery
- IR Receiver Cable
- 5V/2.6A DC Power Adaptor
- Operation Manual

4. SYSTEM REQUIREMENTS

Input source equipment such as Blu-ray/DVD/PS3 player or Set-Top-Box and output HDMI TV/Display with connection cables.

5. FEATURES

- HDMI (with 3D & 4K2K supported) and HDCP compliant
- Select any one of four HDMI sources and display on a HDTV display with fast switching between sources
- Supports 3D signals pass-through
- Supports HDTV resolutions up to 4Kx2K (3840x2160@24/25/30, 50/60 YUV_420 & 4096x2160@24, 50/60 YUV_420)
- Supports HDMI data rate from 300Mbps to 3Gbps and 'Deep Color' up to 1080p/36-bit
- Supports selection of Standard (Fixed) or TV (Downstream) EDID settings
- Supports Audio pass-through of High-definition Audio formats (LPCM 2/5.1/7.1CH, Dolby Digital 2~5.1CH, DTS 2~5.1CH, Dolby TrueHD and DTS-HD Master Audio)
- HDMI inputs support 'Standard' and 'Apple' HDCP modes. Selecting 'Apple' mode guarantees the compatibility of Apple devices with this switcher
- Supports Telnet and WebGUI control

6. OPERATION CONTROLS AND FUNCTIONS

6.1 Front Panel

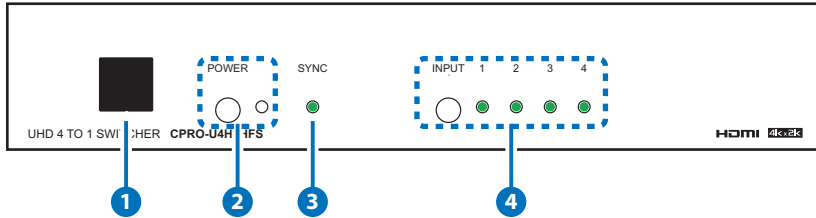

- 1 IR Window:** This IR Receiver receives the remote control signal from the packaged included remote control only with IR frequency at 38kHz.
- 2 POWER & LED:** Press this button to turn ON the device or set the device to standby mode. The LED will illuminate in green when switch to ON. This device contains power last memory and therefore, when the power is connected the device will switch to ON/Standby according to the last status.
***IP Reset:** Press this button together with INPUT button for 3 second under power ON status, when the LED blink for once it means IP Reset complete.
- 3 SYNC:** This LED will illuminate when both input source and output display are linked with active signal.
- 4 IN 1~4:** Press the INPUT button to select an input from the 4 input sources, LED will illuminated according to the selection.

6.2 Rear Panel

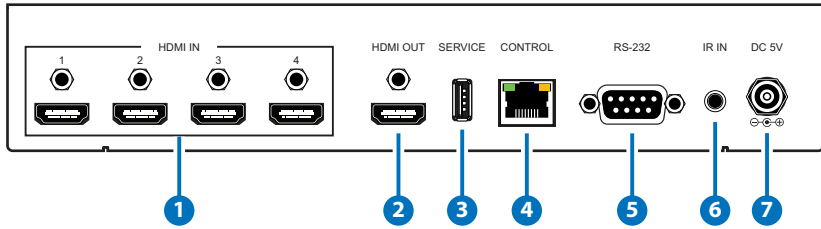

- 1 HDMI IN:** Connect from source equipment such as Blu-ray/DVD/PS3 players, Set-Top-Box or any HDMI equipped source device for input signal sending. The device obtain auto detection function and will detect the last plug-in source for display on output when it is unplugged, the device will detect rotationally from 1~4 input source for display on output.
- 2 HDMI OUT:** Connect to HDMI TV/display or HD Amplifier for output image and or audio display.
- 3 SERVICE:** This slot is reserved for firmware update use only.
- 4 CONTROL:** Connect from PC/Laptop with active internet service for Telnet or WebGUI control with RJ-45 terminated cable.
- 5 RS232:** Connect from PC/Laptop for RS-232 command sending to control the device.
- 6 IR IN:** Connect the IR Receiver included in the package for IR signal receive from the included remote control.
- 7 DC 5V:** Connect the adaptor with power cord included in the package and connect to AC wall outlet for power supply.



6.3 Remote Control

- 1 POWER:** Press this button to switch ON the device or to set it to standby mode.
- 2 INPUT:** Press 1~4 to select input source.

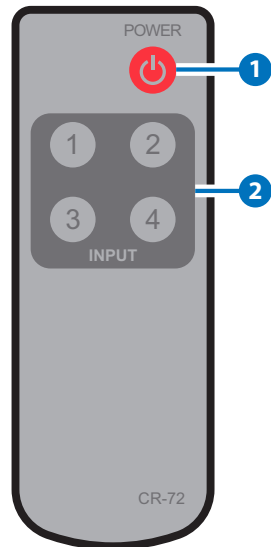

6.4 RS-232 Pin Assignment

Switcher			Remote Control	
PIN	Assignment		PIN	Assignment
1	NC	⇔	1	NC
2	Tx		2	Rx
3	Rx		3	Tx
4	NC		4	NC
5	GND		5	GND
6	NC		6	NC
7	NC		7	NC
8	NC		8	NC
9	NC		9	NC

Baud Rate: 115200bps
Data Bit: 8 bits
Parity: None
Flow Control: None
Stop Bit: 1

6.5 IP Searching Software Application and Installation

Please download the software from www.cypress.com.tw with file name CDPS V2.000 and save it in a directory where you may use it later.

Connect the Control System with PC/Laptop through the Ethernet port through an active network system and open the CDPS V2.000 application. Click on Find Devices on Network and a list of the devices connected to the Control System will show up.

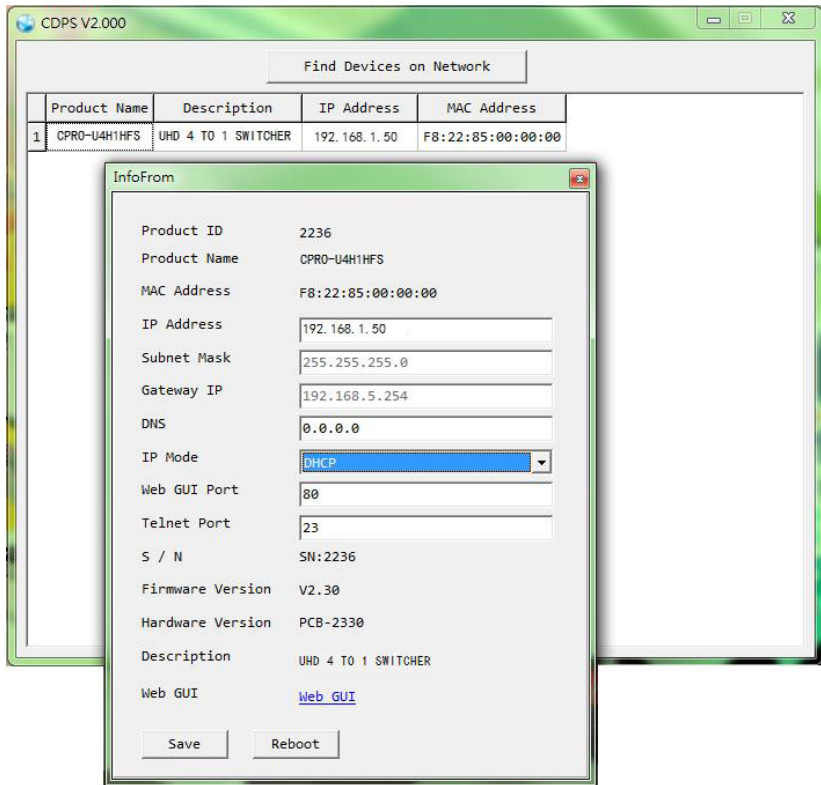

Then user may use the IP Address to find the control device through Telnet, WebGUI or even RS-232/Hyper Terminal tools.



6.6 RS-232 & Telnet Commands

COMMAND NAME	DESCRIPTION	DESCRIPTION OF PARAMETER
P0	Power Off (Standby)	NONE
P1	Power On	NONE
A N	Select Input N	N=1-4
IPCONFIG	Display The Current IP Configure	NONE
SIPADDR XXX.XXX.XXX.XXX	Set Ethernet IP Address	XXX=0~255
SNETMASK XXX.XXX.XXX.XXX	Set Ethernet Net Mask	XXX=0~255
SGATEWAY XXX.XXX.XXX.XXX	Set Ethernet Gateway	XXX=0~255
HTTPPORT N	Set Http Port Number	N=0~65535
RSTIP	IP Configuration Reset To <DHCP>	NONE
EDIDMODE	Show EDID Mode	NONE
EDIDMODE N	Set EDID Mode	N=0(Appoint), 1(All)
EDIDALL	Show EDID Mode Source For All	NONE
EDIDALL N	Set EDID Mode Source For All	N=1-9 (ref. EDID All)
EDIDIN	Show Input EDID Source	NONE
EDIDIN N1	Show Input N1 EDID Source	N1=1-4
EDIDIN N1 N2	Set Input N1 EDID Source	N1=1-4 N2=1-9 (ref. EDID All)
HDCPIN	Input HDCP Status	NONE
HDCPIN N1	Show Input N1 HDCP Status	N1=1-4

COMMAND NAME	DESCRIPTION	DESCRIPTION OF PARAMETER
HDCPIN N1 N2	Set Input N1 HDCP On/Off*	N1=1-4 N2=0(OFF), 1(ON)
SOURCEDET	Show All Inputs Signal	NONE
SOURCEDET N1	Show Input N1 Signal	N1=1-4
SINKINFO	Show Output Information	NONE
INNAME	Show Input Name	NONE
INNAME N1 N2	Set Input Name	N1=1-4 N2=ABCDEFGH(Max Length=8)
OUTNAME	Show Output Name	NONE
OUTNAME A N1	Set HDMI Output Name	N1=ABCDEFGH(Max Length=8)
VER	Show Unit Firmware Version	NONE
REBOOT	System Reboot	NONE
HELP (?)	Show Command List	NONE
HELP N	Show Descript Of Command	N : COMMAND NAME
FADEFAULT	All Configure Set To Factory Default	NONE

Note:

1. All the RS-232 command will be not executed unless followed with a carriage return. Commands are case-sensitive.
2. *HDCP ON/OFF equivalent to HDCP standard and Apple mode.
3. P address's default setting is on statics with 192.168.1.50
4. To find IP address in your zone an easy application is provided, please download it from http://zh-tw.cypress.com.tw/uploadfile/CDPS_20140806_v2000.zip



6.7 EDID Content

	Mode	Selection	Description
EDID Mode	EDID All	HDMI Output(TV)	HDMI Output display EDID
		8/2D/PCM/720p	Build-In EDID, Deep color/2D3D/audio/native resolution
		8/2D/PCM/AC3/720p	Same as above
		8/2D/PCM/1080p	Same as above
		8/2D/PCM/AC3/1080p	Same as above
		8/2D/PCM/4K2K	Same as above
		8/2D/PCM/AC3/4K2K	Same as above
		8/2D/PCM/Y420	Same as above
		8/2D/PCM/AC3/Y420	Same as above
	EDID Appoint	EDID IN1	Input 1's EDID
		EDID IN2	Input 2's EDID
		EDID IN3	Input 3's EDID
		EDID IN4	Input 4's EDID

Note:

1. EDID function only selectable under RS-232 and WebGUI control.
2. When power supply is re-plugged from the device the EDID mode will switch to EDID All- HDMI OUTPUT.

6.8 Telnet Control

To access the telnet control under MS windows, click 'Start' menu and type "cmd" in the search field then press enter.

Under Mac OS X, go to Go → Application → Utilities → Terminal

See below for reference.

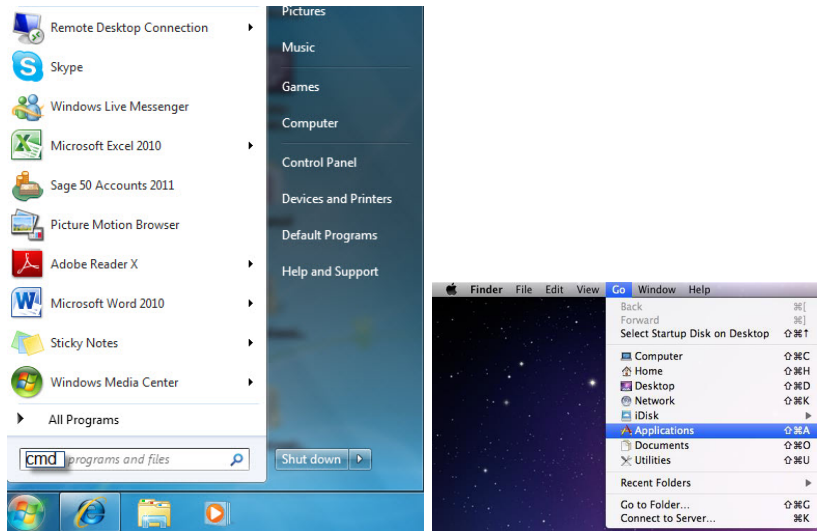

Once in the command line interface (CLI) type "telnet", then the IP address, and hit enter.

```
Microsoft Windows [Version 6.1.7600]
Copyright (c) 2009 Microsoft Corporation. All rights reserved.

C:\Users\CYP>telnet 192.168.5.153 23
```



Press "Help" or "? " then hit enter to bring up all available commands.

```
Welcome to TELNET.
>??
P0      : POWER OFF
P1      : POWER ON
IPCONFIG : DISPLAY THE CURRENT IPCONFIG
SIPADDR : SET ETHERNET IP ADDRESS
SNETMASK : SET ETHERNET NETMASK
SGATEWAY : SET ETHERNET GATEWAY
HTTPPORT : SET HTTP PORT NUMBER
RSTIP    : IP CONFIGURATION RESET TO <DHCP>
A        : SET HDMI OUTPUT SOURCE
EDIDMODE : EDID MODE
EDIDALL  : EDID MODE SOURCE FOR ALL
EDIDIN   : INPUT EDID SOURCE
HDCPIN   : INPUT HDCP STATUS
SOURCEDET : SOURCE SIGNAL DETECT <ON/OFF>
SINKINFO : SINK INFORMATION
INNAME   : INPUT NAME
OUTNAME  : OUTPUT NAME
UER      : SHOW UNIT FIRMWARE VERSION
REBOOT   : SYSTEM REBOOT
?        : SHOW DESCRIPT OF COMMAND
          USE <? N, N=COMMAND NAME> TO SHOW DESCRIPT OF COMMAND
HELP     : SHOW DESCRIPT OF COMMAND
          USE <HELP N, N=COMMAND NAME> TO SHOW DESCRIPT OF COMMAND
FADEFAULT : ALL CONFIGURE SET TO FACTORY DEFAULT
>
```

Note: Any commands will not be executed unless followed by a carriage return. Commands are case-insensitive. If the IP is changed then the IP Address required for Telnet access will also change accordingly.

6.9 WebGUI Control

On a PC/Laptop that is connected to an active network system, open a web browser and type device's IP address (the default statics IP is 192.168.1.50 or available from RS-232 or use the link application from note 4 in section 6.5 to find) on the web address entry bar. The browser will display the device's Status, IO Status, EDID Control, Settings and Network Configuration control pages for users to control.

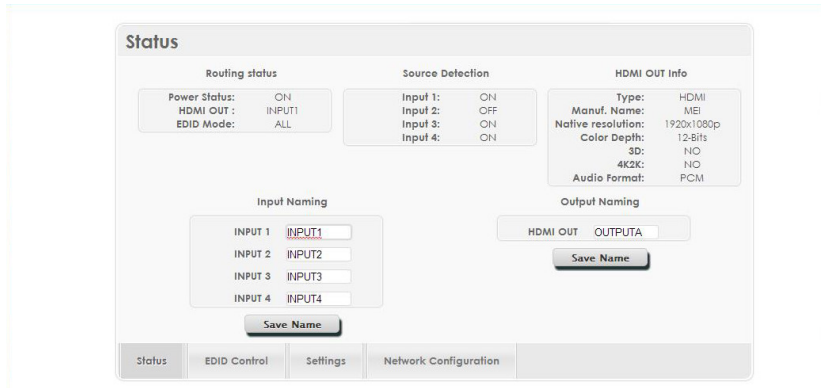

Click on EDID Control for EIDID selections.

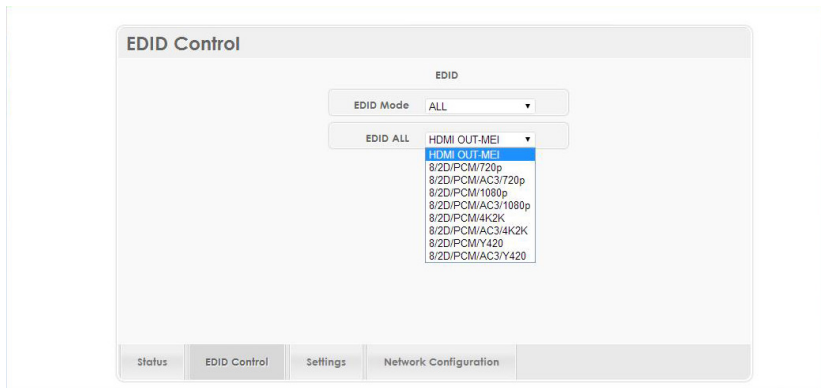

Click on Settings to set each input's HDCP Control and Preset Configuration. HDCP Enable and Disable equivalence to HDCP standard and Apple mode.

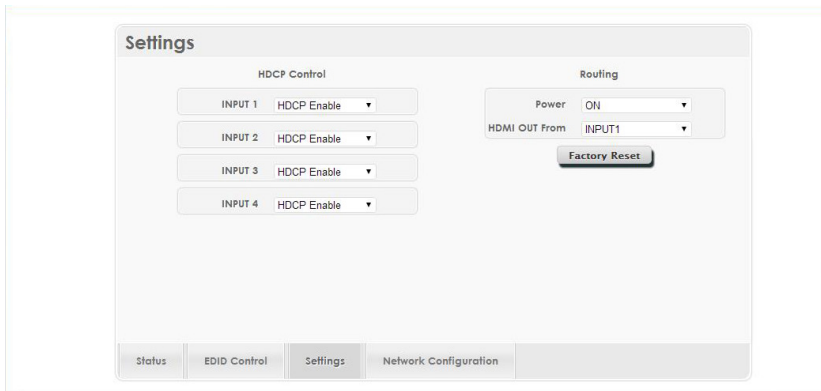

Click on Network Configuration to set the device's IP configuration once the changes is saved the system will reset the IP address on the device automatically and user will need to re-enter the IP address to continue the WebGUI function.

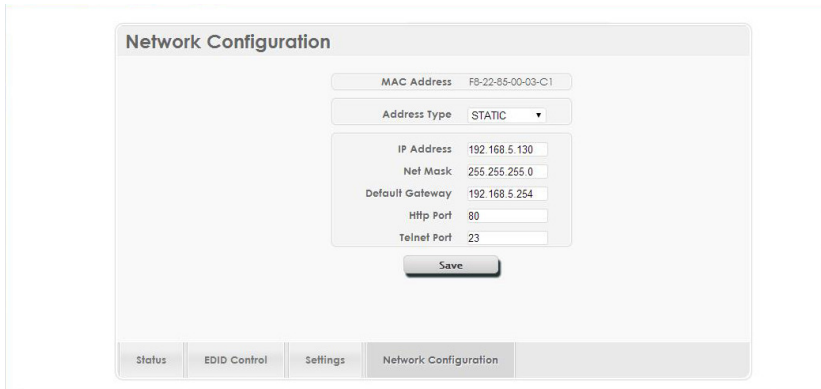

7. CONNECTION DIAGRAM

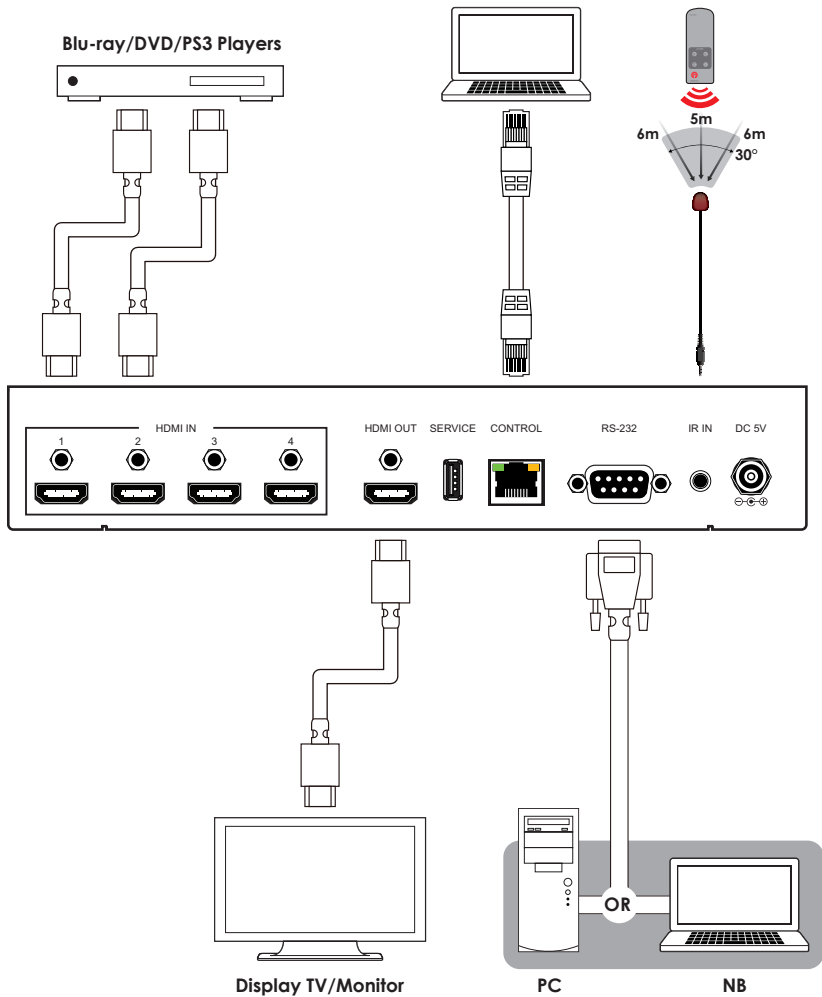

Note: The IR Extender cable distance is up to 5 meters and 8 meters for the IR Window on the front panel.



8. SPECIFICATIONS

Frequency bandwidth	300Mbps to 3Gbps
Input Ports	4 x HDMI, 1 x USB (Service only), 1 x RJ45 (Control), 1 x RS-232, 1 x IR Extender
Output ports	1 x HDMI
Resolution	480i~1080p@50/60, 1080p@24, 4K2K (3840x2160@24/25/30, 50/60 YUV_420 & 4096x2160@24, 50/60YUV_420)
HDMI I/O Cable Distance	15M@8/12bit, 5M@4Kx2K
IR Frequency	30~50kHz
Power Supply	5VDC/2.6A (US/EU standards, CE/FCC/UL certified)
ESD Protection	Human Body model: ± 8kV (air-gap discharge) ± 4kV (contact discharge)
Dimensions	240mm (W) x 104mm (D) x 43mm (H)/ Jacks Excluded 240mm (W) x 111.2mm (D) x 48mm (H)/ Jacks Included
Weight	798g
Chassis Material	Metal
Silkscreen Color	Black
Operating Temperature	0°C~40°C / 32°F ~ 104°F
Storage temperature	-20°C~60°C / -4°F ~ 140°F
Relative Humidity	20~90% RH (no condensation)
Power Consumption	4W

DVI and HDMI Supported Resolutions	Input	Output
640x480@60	✓	✓
640x480@72	✓	✓
640x480@75	✓	✓
720x480@60	✓	✓
720x576p@50	✓	✓
800x600@60	✓	✓
800x600@72	✓	✓
800x600@75	✓	✓
1024x768@60	✓	✓
1024x768@70	✓	✓
1024x768@75	✓	✓
1280x720@50	✓	✓
1280x720@60	✓	✓
1280x720p@60	✓	✓
1280x768@60	✓	✓
1280x800@60	✓	✓
1280x1024@60	✓	✓
1360x768@60	✓	✓
1600x1200@60	✓	✓
1920x1080i@50	✓	✓
1920x1080i@60	✓	✓
1920x1080p@24	✓	✓
1920x1080p@25	✓	✓
1920x1080p@30	✓	✓
1920x1080p@50	✓	✓
1920x1080p@60	✓	✓
1920x1200@60(RB)	✓	✓
3840x2160@24/25/30, 50/60 Y420	✓	✓
4096x2160@24/,50/60 Y420	✓	✓



Audio Sampling Rate Up to 192 kHz

HDMI input (Up to 192kHz)	HDMI output
LPCM 2CH	√
LPCM 5.1CH	√
LPCM 7.1CH	√
Dolby Digital 2~5.1CH/ DTS 2~5.1CH	√
Dolby TrueHD/ DTS-HD Master Audio	√

Audio Format LPCM 2/5.1/7.1CH, Dolby Digital 2~5.1CH, DTS 2~5.1CH (Pass through), Dolby TrueHD and DTS-HD Master Audio

9. ACRONYMS

ACRONYM	COMPLETE TERM
HDCP	High-bandwidth Digital Content Protection
HDMI	High Definition Multimedia Interface
4Kx2K	3840x2160/ 4096x2160



CYPRESS TECHNOLOGY CO., LTD

Home page: <http://www.cypress.com.tw>

MPM-CPROU4H1HFS