



# CPLUS-V6H2HP

4K UHD+ 6×2 HDMI Matrix  
with Audio De-Embedding



## Operation Manual



## **DISCLAIMERS**

The information in this manual has been carefully checked and is believed to be accurate. Cypress Technology assumes no responsibility for any infringements of patents or other rights of third parties which may result from its use.

Cypress Technology assumes no responsibility for any inaccuracies that may be contained in this document. Cypress also makes no commitment to update or to keep current the information contained in this document.

Cypress Technology reserves the right to make improvements to this document and/or product at any time and without notice.

## **COPYRIGHT NOTICE**

No part of this document may be reproduced, transmitted, transcribed, stored in a retrieval system, or any of its part translated into any language or computer file, in any form or by any means—electronic, mechanical, magnetic, optical, chemical, manual, or otherwise—without express written permission and consent from Cypress Technology.

© Copyright 2017 by Cypress Technology.

All Rights Reserved.

## **TRADEMARK ACKNOWLEDGMENTS**

All products or service names mentioned in this document may be trademarks of the companies with which they are associated.





## SAFETY PRECAUTIONS

Please read all instructions before attempting to unpack, install or operate this equipment and before connecting the power supply.

Please keep the following in mind as you unpack and install this equipment:

- Always follow basic safety precautions to reduce the risk of fire, electrical shock and injury to persons.
- To prevent fire or shock hazard, do not expose the unit to rain, moisture or install this product near water.
- Never spill liquid of any kind on or into this product.
- Never push an object of any kind into this product through any openings or empty slots in the unit, as you may damage parts inside the unit.
- Do not attach the power supply cabling to building surfaces.
- Use only the supplied power supply unit (PSU). Do not use the PSU if it is damaged.
- Do not allow anything to rest on the power cabling or allow any weight to be placed upon it or any person walk on it.
- To protect the unit from overheating, do not block any vents or openings in the unit housing that provide ventilation and allow for sufficient space for air to circulate around the unit.

## REVISION HISTORY

VERSION NO.	DATE (DD/MM/YY)	SUMMARY OF CHANGE
RDV1	29/06/16	Preliminary release
VS1	30/08/17	Updated text/diagrams
VS2	05/09/17	Changed remote control



# CONTENTS

<b>1. Introduction</b> .....	<b>1</b>
<b>2. Applications</b> .....	<b>1</b>
<b>3. Package Contents</b> .....	<b>1</b>
<b>4. System Requirements</b> .....	<b>2</b>
<b>5. Features</b> .....	<b>2</b>
<b>6. Operation Controls and Functions</b> .....	<b>3</b>
6.1 Front Panel .....	3
6.2 Rear Panel.....	5
6.3 Remote Control.....	6
6.4 IR Cable Pin Assignments .....	7
6.5 RS-232 Protocol.....	7
6.6 RS-232 and Telnet Commands .....	8
6.7 Telnet Control .....	12
6.8 WebGUI Control.....	13
6.8.1 Device Discovery APP .....	13
6.8.2 WebGUI Overview .....	14
<b>7. Connection Diagram</b> .....	<b>20</b>
<b>8. Specifications</b> .....	<b>21</b>
8.1 Technical Specifications .....	21
8.2 Video Specifications.....	22
<b>9. Acronyms</b> .....	<b>23</b>





## 1. INTRODUCTION

This 4K UHD+ 6 by 2 Matrix provides the ability to connect up to six 4K UHD HDMI sources to up to two 4K UHD HDMI displays and freely switch between them. This unit comes with full support for 18Gbps (600Mhz) resolutions up to, and including 4K@60Hz (4:4:4, 8-bit) as well as support for 16-bit Deep Color (up to 1080p@60Hz), HDR (High Dynamic Range), HD audio and other features defined by the HDMI 2.0 specification. With a comprehensive EDID management feature that includes the ability to select between six built in default EDIDs, or an EDID copied from a connected sink device, this matrix can solve many interconnectivity problems. Added flexibility comes from the ability to extract audio from each HDMI output's source and output it as optical digital audio (LPCM 2.0 and standard Bitstream only). Six fully configurable presets are also provided to simplify the routing process. This unit provides an intuitive set of front panel controls with associated LCD, as well as RS-232, Telnet, WebGUI, and IR remote control options.

## 2. APPLICATIONS

- Entertainment Rooms & Home Theaters
- Lecture Rooms
- Showrooms & Demo Rooms
- Public Commercial Displays

## 3. PACKAGE CONTENTS

- 1×4K UHD+ 6 by 2 HDMI Matrix
- 1×Remote Control (CR-175)
- 1×IR Extender Cable
- 1×5V/3A DC Power Adaptor
- 1×Rack Mount Ears (Set of 2)
- 1×Operation Manual

## 4. SYSTEM REQUIREMENTS

- HDMI source equipment such as media players, video game consoles or set-top boxes.
- HDMI receiving equipment such as HDTVs, monitors or audio amplifiers.
- The use of "Premium High Speed HDMI" cables is highly recommended.

## 5. FEATURES

- HDMI input and output with 18Gbps (600MHz) 4K UHD support
- DVI 1.0 compliant with the use of an HDMI-DVI adaptor
- HDCP 1.4 and 2.2 compliant
- Supports HD resolutions up to 3840×2160@60Hz (YUV 4:4:4, 8-bit) and 4096×2160@60Hz (YUV 4:4:4, 8-bit)
- Supports 16-bit Deep Color up to 1080p@60Hz
- 6 HDMI inputs and 2 HDMI outputs
- Supports pass-through of audio formats including LPCM 2.0/5.1/7.1, Bitstream, and HD Bitstream
- Display any of 6 high-definition sources on up to 2 HDTV displays simultaneously
- Optical audio extraction paired with each HDMI output (LPCM 2.0 or Bitstream only)
- Supports 6 internal EDIDs or 2 external EDIDs copied from connected devices
- Controllable via front panel buttons with LCD, WebGUI, Telnet, RS-232, and IR remote

## 6. OPERATION CONTROLS AND FUNCTIONS

### 6.1 Front Panel

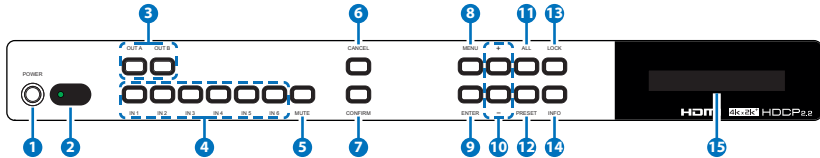

- 1 POWER:** Press this button to power the unit on (green LED) or place it into stand-by mode (red LED).

*Note: Ethernet, RS-232, and IR remain active while the unit is in stand-by mode.*
- 2 IR WINDOW:** Accepts IR signals from the included IR remote for control of this unit only.
- 3 OUT A~B:** Press the “OUT” keys (A or B) of the outputs you wish to route a source to (the letter will flash in the LCD to indicate selection). Pressing an OUT button a second time will de-select that output.
- 4 IN 1~6:** After selecting one or more outputs, press the “IN” key of the input (1~6) you wish to route to the selected output(s). In Preset selection mode, these buttons are used to select the saved preset to use.

*Note: The “CONFIRM” button (Item 7) must be pressed to activate the selected routing configuration.*
- 5 MUTE:** The “MUTE” button functions as a blank audio/video source. To use it, follow the standard matrix routing instructions, but use the “MUTE” button as the input to blank out the selected outputs. When a “MUTE” input is in use it will show up as “M” within the routing display.
- 6 CANCEL:** Press to cancel/undo any un-confirmed routing change selections.
- 7 CONFIRM:** Press to confirm and activate newly made input/output routing selections.

*Note: It is possible to configure multiple I/O routes prior to pressing the “CONFIRM” button.*



- 8 **MENU:** Press to enter the LCD menu, or to back out from menu items.
- 9 **ENTER:** Press to confirm a selection within the LCD menu or to go deeper into a menu item.
- 10 **+ & -:** Press to move up and down or adjust selections within the LCD menus.
- 11 **ALL:** Press this button to select all outputs simultaneously for routing (the letters will flash in the LCD to indicate selection). Press it a second time to de-select all outputs.
- 12 **PRESET:** Press to enter the preset recall menu in the LCD window. Press the numbered "IN" button of the Preset you wish to activate followed by the "CONFIRM" button to activate it.
- 13 **LOCK:** Press to lock all button functions on the front panel. Press and hold for 3 seconds to release the lock function. The LCD will display "Lock" when the function is active.
- 14 **INFO:** Press to show the current input/output routing and detected resolution on each output's OSD.
- 15 **LCD WINDOW:** Displays the unit's menu, settings, and information.

## 6.2 Rear Panel

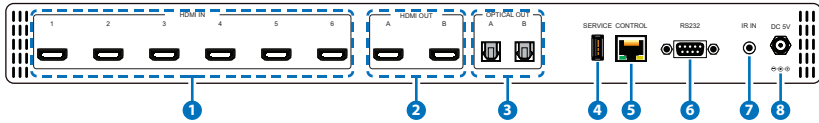

- 1 HDMI IN 1~6:** Connect to HDMI source equipment such as media players, game consoles or set-top boxes. DVI source equipment may be connected by using HDMI to DVI adapters.
- 2 HDMI OUT A~B:** Connect to HDMI TVs, monitors or amplifiers for digital video and audio output. DVI display equipment may be connected by using HDMI to DVI adapters.
- 3 OPTICAL OUT A~B:** Connect to powered speakers or amplifiers for digital audio output using appropriate optical cables. The audio from each optical output will be the same as the HDMI output it is paired with (LPCM 2.0 and standard Bitstream only).
- 4 SERVICE:** This slot (USB 2.0) is reserved for firmware update use only.
- 5 CONTROL:** Connect directly, or through a network switch, to your PC/laptop to control the unit via Telnet/WebGUI.
- 6 RS-232:** Connect directly to your PC/laptop to send RS-232 commands to control the unit.
- 7 IR IN:** Connect to the provided IR Extender to extend the IR control range of the unit. Ensure that the remote being used is within direct line-of-sight of the IR Extender.
- 8 DC 5V:** Plug the 5V DC power adapter into the unit and connect it to an AC wall outlet for power.

## 6.3 Remote Control

- 1 **POWER:** Press this button to switch the unit between On and Stand-by mode.
- 2 **OUT A~B:** Press the button (A or B) of the output(s) you wish to route a source to. Pressing an OUT button a second time will de-select that output.
- 3 **INFO:** Press to show the current input/output routing and detected resolution on each output's OSD.
- 4 **MUTE:** Press this button to route a blank audio/video source to the selected output(s).
- 5 **MENU:** Press to enter the LCD menu, or to back out from menu items.
- 6 **LOCK:** Press to lock all button functions on the front panel. Press and hold for 3 seconds to release the lock function.
- 7 **ALL:** Press to select all outputs simultaneously for routing. Press it a second time to de-select all outputs.  
**CONFIRM:** Press to confirm and activate newly made input/output routing selections.  
**CANCEL:** Press to cancel/undo any un-confirmed routing change selections.  
**PRESET:** Press to enter the preset recall menu in the LCD window. Press the numbered "IN" button of the Preset you wish to activate followed by the "TAKE" button to activate it.
- 8 **IN 1~6:** After selecting one or more outputs, press the "IN" button of the input (1~6) you wish to route to the selected output(s). In Preset selection mode, these buttons are used to select the saved preset to use.
- 9 **ENTER:** Press to confirm a selection within the LCD menu or to go deeper into a menu item.  
**+ & -:** Press to move up and down or adjust selections within the LCD menus.

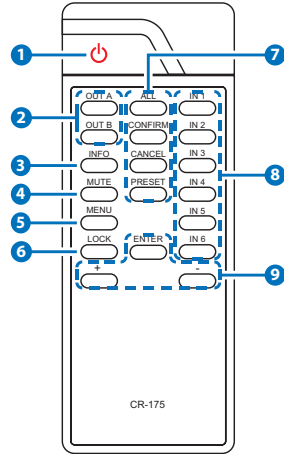

## 6.4 IR Cable Pin Assignments

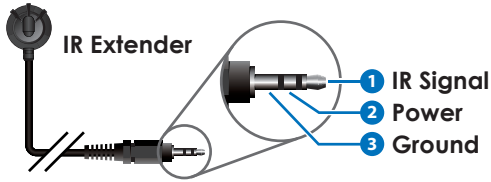

## 6.5 RS-232 Protocol

UNIT			REMOTE SYSTEM	
Pin	Definition		Pin	Definition
1	NC		1	NC
2	TxD		2	RxD
3	RxD	▶	3	TxD
4	NC	◀	4	NC
5	GND		5	GND
6	NC		6	NC
7	NC		7	NC
8	NC		8	NC
9	NC		9	NC

Baud Rate: 115200bps

Data Bits: 8

Parity Bits: None

Stop Bit: 1

Flow Control: None

## 6.6 RS-232 and Telnet Commands

COMMAND	DESCRIPTION AND PARAMETERS
<b>HELP</b>	Show the full command list.
<b>?</b>	Show the full command list.
<b>? N1</b>	Show help details about command N1. N1 = {Any command name}
<b>P0</b>	Turn unit's power off. (Stand-by mode)
<b>P1</b>	Turn unit's power on.
<b>INNAME N1 N2</b>	Set the name of input N1 to N2. N1 = 1~6 [Input number] N2 = {name} [8 characters max]
<b>INNAME N1</b>	Show the input name of N1. N1 = 1~6 [Input number]
<b>INNAME</b>	Show the names of all inputs.
<b>OUTNAME N1 N2</b>	Set the name of output N1 to N2. N1 = A~B [Output letter] N2 = {name} [8 characters max]
<b>OUTNAME N1</b>	Show the name of output N1. N1 = A~B [Output letter]
<b>OUTNAME</b>	Show the names of all inputs.
<b>A N1</b>	Set the input to be routed to output A. N1 = 1~6 [Input number]
<b>A</b>	Show the current input routing for output A.
<b>B N1</b>	Set the input to be routed to output B. N1 = 1~6 [Input number]
<b>B</b>	Show the current input routing for output B.

COMMAND	DESCRIPTION AND PARAMETERS
<b>OUT N1</b>	Set a single input to be routed to both outputs (A & B). N1 = 1~6 [Input number]
<b>OUT</b>	Show the current input routing for both outputs.
<b>PRESET N1 N2</b>	Set the routing for preset N1 to configuration N2. N1 = 1~6 [Preset number] N2 = AxBx [x = 1~6]
<b>PRESET N1</b>	Activate preset N1. N1 = 1~6 [Preset number]
<b>PRESET</b>	Show the current preset routing configuration.
<b>SOURCEDET</b>	Show all source detection information.
<b>SINKINFO</b>	Show all sink information.
<b>HDCPIN N1 N2</b>	Set the HDCP mode for input N1. N1 = 1~6 [Input number] Available values for N2: 0 [Standard] 1 [Apple Mode]
<b>HDCPIN N1</b>	Show the HDCP settings for input N1. N1 = 1~6 [Input number]
<b>HDCPIN</b>	Show all current HDCP input settings.
<b>EDIDMODE N1</b>	Set the EDID mode. Available values for N1: 0 [Appoint] 1 [All]
<b>EDIDMODE</b>	Show the current EDID mode setting.

COMMAND	DESCRIPTION AND PARAMETERS
<b>EDIDALL</b>	Set the EDID to use in "All" mode. Available values for N1: 0 [OUTPUT A] 1 [OUTPUT B] 2 [FHD/2ch] 3 [FHD/Mch] 4 [4K UHD/2ch] 5 [4K UHD/Mch] 6 [4K UHD+/2ch] 7 [4K UHD+/Mch]
<b>EDIDALL</b>	Show the current EDID selection for "All" mode.
<b>EDIDIN N1 N2</b>	Set the EDID to use in "Appoint" mode. N1 = 1~6 [Input number] Available values for N2: 0 [OUTPUT A] 1 [OUTPUT B] 2 [FHD/2ch] 3 [FHD/Mch] 4 [4K UHD/2ch] 5 [4K UHD/Mch] 6 [4K UHD+/2ch] 7 [4K UHD+/Mch]
<b>EDIDIN N1</b>	Show the current EDID selection for input N1 in "Appoint" mode. N1 = 1~6 [Input number]
<b>EDIDIN</b>	Show the current EDID selections for all inputs in "Appoint" mode.
<b>FADEFAULT</b>	Reset the unit to the factory defaults.
<b>REBOOT</b>	Reboot the unit.

COMMAND	DESCRIPTION AND PARAMETERS
<b>LOCK N1</b>	Set the front panel lock state for the unit. Available values for N1: 0 [Off] 1 [On]
<b>LOCK</b>	Show the current front panel lock state.
<b>VER</b>	Show the unit's current firmware version.
<b>IPCONFIG</b>	Show the current IP configuration.
<b>SIPADDR N1</b>	Set the static IP Address. N1 = X.X.X.X [X = 0~255]
<b>SNETMASK N1</b>	Set the Ethernet netmask. N1 = X.X.X.X [X = 0~255]
<b>SGATEWAY N1</b>	Set the Ethernet gateway. N1 = X.X.X.X [X = 0~255]
<b>HTTPPORT N1</b>	Set the HTTP port. N1 = 0~65535
<b>TELNETPORT N1</b>	Set the Telnet port. N1 = 0~65535
<b>IPMODE N1</b>	Set the current IP address mode. Available values for N1: 0 [Static IP] 1 [DHCP]
<b>READMAC</b>	Show the unit's MAC address.
<b>UPDATE</b>	Update firmware.

*Note: Commands will not be executed unless followed by a carriage return. Commands are not case-sensitive.*



## 6.7 Telnet Control

Before attempting to use Telnet control, please ensure that both the unit and the PC/Laptop are connected to the same active networks.

To access the Command Line Interface (CLI)	
In Windows XP	Click <b>Start &gt; Run</b> , type "cmd" in the search field, and press <b>Enter</b> .
In Windows 7	Click <b>Start</b> , type "cmd" in the search field, and press <b>Enter</b> .
In Mac OS X	Click <b>Go &gt; Applications &gt; Utilities &gt; Terminal</b> .

Once in the CLI (Command Line Interface) type "Telnet" followed by the IP address of the unit and "23", then hit "Enter".

```
Microsoft Windows [Version 6.1.7601]
Copyright (c) 2009 Microsoft Corporation. All rights reserved.

C:\Users\Administrator>telnet 192.168.1.50 23
```

This will connect us to the unit we wish to control. Type "help" to list the available commands.

*Note: The unit's default IP address is 192.168.1.50. If the IP address is changed then the IP address required for Telnet access will also change accordingly.*

## 6.8 WebGUI Control

### 6.8.1 Device Discovery APP

Please obtain the “Device Discovery” software from your authorized dealer and save it in a directory where you can easily find it.

Connect the unit and your PC/Laptop to the same active network and execute the “Device Discovery” software. Click on “Find Devices on Network” and a list of devices connected to the local network will show up indicating their current IP address. (The unit’s default IP address is 192.168.1.50)

Product Name	Description	IP Address	MAC Address

By clicking on one of the listed devices you will be presented with the network details of that particular device.

Product ID  
Product Name  
MAC Address 00:00:00:00:00:00  
IP Address  
Subnet Mask  
Gateway IP  
DNS  
IP Mode Static  
Web GUI Port Static  
Telnet Port 0  
S / N  
Firmware Version  
Hardware Version  
Description  
Web GUI [Web GUI](#)  
Save Reboot

- **IP Mode:** If you choose, you can alter the static IP network settings for the device, or switch the unit into DHCP mode to automatically obtain proper network settings from a local DHCP server. To switch to DHCP mode, please select DHCP from the IP mode drop-down, then click “Save” followed by “Reboot”.
- **WebGUI Hotkey:** Once you are satisfied with the network settings, you may use them to connect via Telnet or WebGUI. The network information window provides a convenient link to launch the WebGUI directly.

## 6.8.2 WebGUI Overview

All functions, including status, power, input selection, preset activation & management, EDID management, HDCP management, Ethernet settings, and reset/firmware functions are controllable via multiple tabs in the WebGUI interface allowing for intuitive operation. To view the contents of a tab, click on the appropriate button at the bottom of the window. The individual tabs and functions will be introduced in the following sections.

### Status

The status tab provides access to information about the current routing selection and power state. It also provides information about each preset's configuration as well as a button to instantly activate each preset.

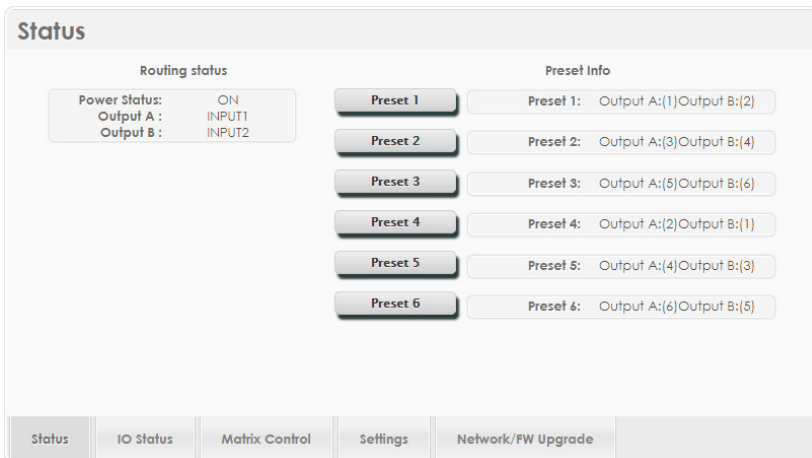

The screenshot shows the 'Status' tab in the WebGUI interface. It is divided into two main sections: 'Routing status' and 'Preset Info'. The 'Routing status' section displays the current power and output settings: Power Status is ON, Output A is INPUT1, and Output B is INPUT2. The 'Preset Info' section lists six presets, each with a button to activate it and a corresponding output configuration: Preset 1 (Output A:(1)Output B:(2)), Preset 2 (Output A:(3)Output B:(4)), Preset 3 (Output A:(5)Output B:(6)), Preset 4 (Output A:(2)Output B:(1)), Preset 5 (Output A:(4)Output B:(3)), and Preset 6 (Output A:(6)Output B:(5)). At the bottom of the interface, there is a navigation bar with tabs for Status, IO Status, Matrix Control, Settings, and Network/FW Upgrade.

To activate a stored preset, click on the appropriate button. The new routing will take effect immediately.

## I/O Status

This tab provides detailed information about all connected sink devices including type, manufacturer name, native resolution, color depth, 3D support, 4K support and audio format support as well as basic source detection information.

### IO Status

**Source Detection**

Input 1: <input type="checkbox"/> ON	Input 4: <input type="checkbox"/> OFF
Input 2: <input type="checkbox"/> ON	Input 5: <input type="checkbox"/> OFF
Input 3: <input type="checkbox"/> ON	Input 6: <input type="checkbox"/> OFF

**Sink A Info**

Type:	HDMI2.0
Manuf. Name:	STD
Native resolution:	3840x2160p
Color Depth:	8
3D:	NO
4K2K:	YES
Audio Format:	PCM

**Sink B Info**

Type:	HDMI2.0
Manuf. Name:	STD
Native resolution:	3840x2160p
Color Depth:	8
3D:	NO
4K2K:	YES
Audio Format:	PCM/BitStream/HD

**Input Naming**

INPUT 1	<input type="text" value="INPUT1"/>	INPUT 4	<input type="text" value="INPUT4"/>
INPUT 2	<input type="text" value="INPUT2"/>	INPUT 5	<input type="text" value="INPUT5"/>
INPUT 3	<input type="text" value="INPUT3"/>	INPUT 6	<input type="text" value="INPUT6"/>

**Output Naming**

OUTPUT A	<input type="text" value="OUTPUTA"/>
OUTPUT B	<input type="text" value="OUTPUTB"/>

Status
IO Status
Matrix Control
Settings
Network/FW Upgrade

When a live input source is detected on one of the 6 HDMI inputs the corresponding input in this tab will display "ON". If no source is detected on that input, it will display "OFF".

The six HDMI input ports and two HDMI output ports may be freely renamed. Each name can be up to 8 characters long. Please click the associated "Save Name" button to store any changes made.

## Matrix Control

This tab provides direct control over the unit's power state, input/output routing, and EDID management. A way to reboot the unit, or perform a factory reset is also provided.

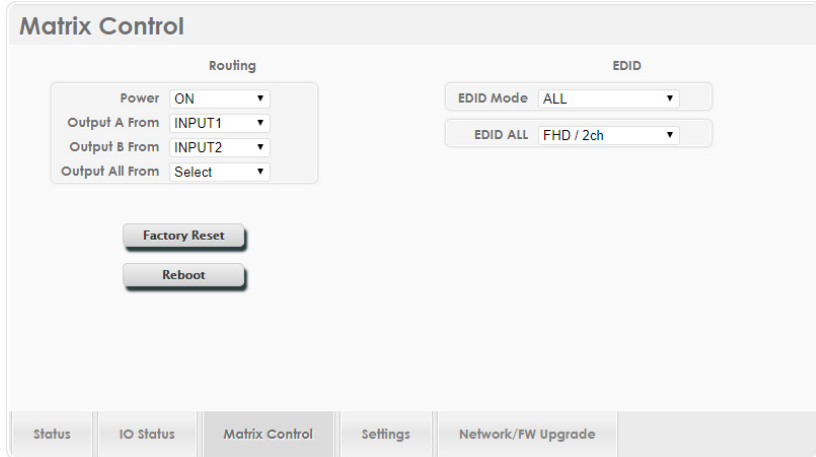

Any of the available inputs may be selected as a source for either of the two outputs by selecting the preferred input from the dropdown next to the “Output A” and “Output B” text.

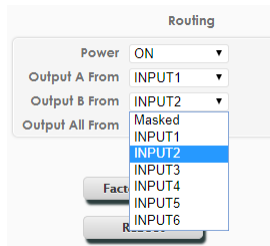

It is also possible to select a single source to be routed to both outputs quickly by selecting a source from the “Output All From” dropdown. Selecting “Masked” will output a blank video signal with no audio.

The EDID section of the Matrix Control tab controls the EDID management for the unit. All inputs can share the same assigned EDID, or each input can have a discrete EDID assigned to it.

*Note: Changes to the EDID selection will result in a brief blanking of the video signal.*

- Selecting the “ALL” mode will send the selected EDID to all inputs.
- Selecting the “APPOINT” mode allows each input to have a different EDID assigned to it.

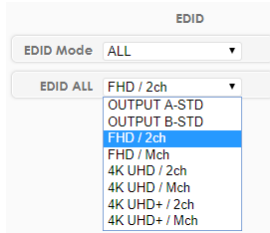

The available EDID options are:

- **OUTPUT A:** EDID is passed from the currently connected display
- **OUTPUT B:** EDID is passed from the currently connected display
- **FHD/2ch:** 1080p@60Hz, 8-bit & LPCM 2.0
- **FHD/Mch:** 1080p@60Hz, 8-bit & LPCM 7.1/Bitstream/HD Bitstream
- **4K UHD/2ch:** 4K@30Hz, 8-bit & LPCM 2.0
- **4K UHD/Mch:** 4K@30Hz, 8-bit & LPCM 7.1/Bitstream/HD Bitstream
- **4K UHD+/2ch:** 4K@60Hz (4:4:4), 8-bit & LPCM 2.0
- **4K UHD+/Mch:** 4K@60Hz (4:4:4), 8-bit & LPCM 7.1/Bitstream/HD Bitstream

The unit can also be powered on or off from this tab. Note that Ethernet, RS-232, and IR will remain active while the unit is in “OFF” (stand-by) mode. To perform a factory reset on the unit, please click the “Factory Reset” button. To reboot the unit, please click the “Reboot” button.

## Settings

This tab allows for control over each inputs HDCP mode as well as configuration of all 6 routing presets.

### Settings

#### HDCP Control

INPUT 1	Standard
INPUT 2	Standard
INPUT 3	Standard
INPUT 4	Standard
INPUT 5	Standard
INPUT 6	Standard

#### Preset Configuration

PRESET 1:	OUTPUT A	Input 1	OUTPUT B	Input 2
PRESET 2:	OUTPUT A	Input 3	OUTPUT B	Input 4
PRESET 3:	OUTPUT A	Input 5	OUTPUT B	Input 6
PRESET 4:	OUTPUT A	Input 2	OUTPUT B	Input 1
PRESET 5:	OUTPUT A	Input 4	OUTPUT B	Input 3
PRESET 6:	OUTPUT A	Input 6	OUTPUT B	Input 5

Status	IO Status	Matrix Control	Settings	Network/FW Upgrade
--------	-----------	----------------	----------	--------------------

The HDCP mode for each input may be switched between the “Standard” and “Apple” modes. “Apple” mode allows for the display of non-HDCP required content from Apple, and similar, devices on non-HDCP displays.

*Note: Changes to the HDCP mode may result in a brief blanking of the video signal.*

All 6 routing presets may be set here as well. Select the preferred video source (or “Masked” for a blank video signal with no audio) for each output to be recalled when the specified preset is activated.

## Network/FW Upgrade

This tab provides control over the unit's network settings as well as providing a simple way to update the unit's firmware, if necessary.

Network/FW Upgrade

MAC Address FF-FF-FF-FF-FF-FF

Address Type STATIC

IP Address 192.168.1.50

Net Mask 255.255.255.0

Default Gateway 192.168.1.254

Http Port 80

Telnet Port 23

Save

Firmware upgrade BROWSE... UPDATE

Status IO Status Matrix Control Settings Network/FW Upgrade

The Address Type dropdown allows selection between Static IP (manual configuration) or DHCP (automatic IP configuration) modes. When in STATIC mode the IP address, netmask and gateway can be defined manually. The HTTP and Telnet ports can also be changed from their defaults here. After making any changes, please press "Save" to store the new settings in the unit. If the IP address has been changed, it will be necessary to re-connect to the WebGUI using the new IP address.

The Firmware Upgrade section of this tab provides a way to easily update the firmware of the unit.

- **BROWSE:** Click the "BROWSE" button to select the firmware update \*.bin file which is located on your local PC.
- **UPDATE:** Click the "UPDATE" button to begin the firmware update process.



## 7. CONNECTION DIAGRAM

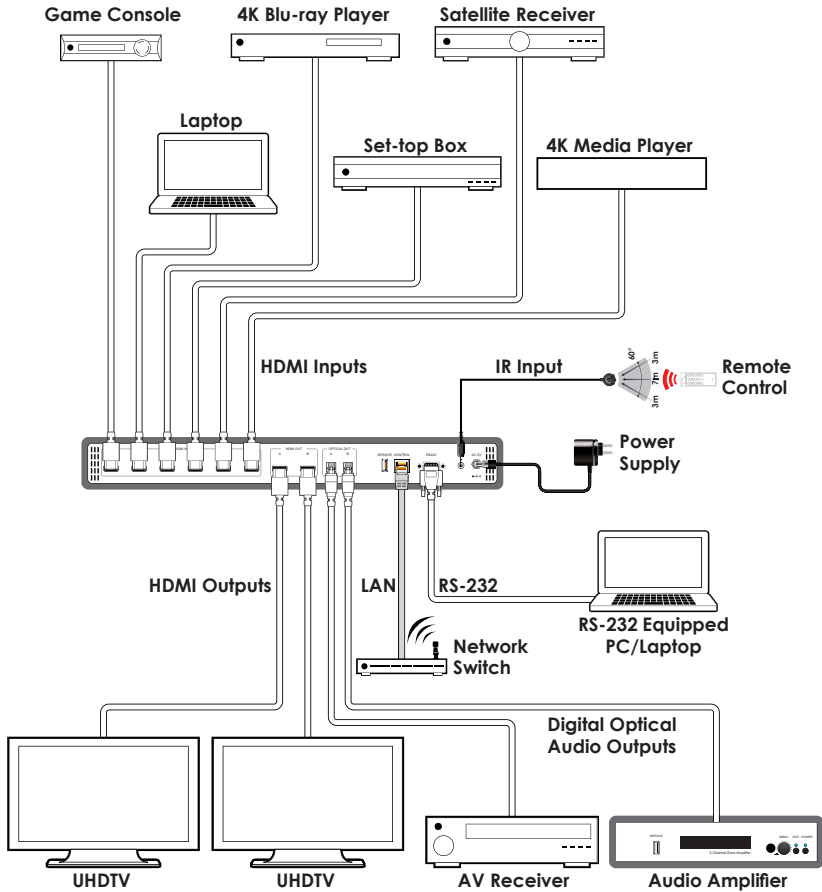



## 8. SPECIFICATIONS

### 8.1 Technical Specifications

<b>Video Bandwidth</b>	600MHz/18Gbps
<b>Input Ports</b>	6×HDMI
<b>Output Ports</b>	2×HDMI 2×TOSLINK (S/PDIF Audio)
<b>Control Interfaces</b>	1×IR Extender (3.5mm) 1×RS-232 (9-pin D-sub) 1×IP Control (RJ45)
<b>Supported Resolutions</b>	480i@60Hz - 4K@60Hz (4:4:4, 8-bit) VGA@60Hz - WUXGA@60Hz (RB)
<b>HDMI Cable Length</b>	10m (1080p@60Hz, 12-bit) 5m (4K@60Hz, 4:4:4, 8-bit)
<b>IR Frequency</b>	30 - 50kHz (30 - 60kHz under ideal conditions)
<b>Baud Rate</b>	115200bps
<b>Power Supply</b>	5V/3A DC (US/EU standards, CE/FCC/UL certified)
<b>ESD Protection</b>	Human Body Model: ±12kV (Air Discharge) ±8kV (Contact Discharge)
<b>Dimensions</b>	438mm×44mm×269mm (W×H×D) [Case Only] 482mm×52mm×276mm (W×H×D) [All Inclusive]
<b>Weight</b>	2,840g
<b>Chassis Material</b>	Metal
<b>Silkscreen Color</b>	Black
<b>Operating Temperature</b>	0°C - 40°C/32°F - 104°F
<b>Storage Temperature</b>	-20°C - 60°C/-4°F - 140°F

**Relative Humidity**            20 - 90% RH (Non-condensing)  
**Power Consumption**        12.65W

## 8.2 Video Specifications

Supported Resolutions (Hz)	Input	Output
640×480@60/72/75/85	✓	✓
800×600@60/72/75/85	✓	✓
1024×768@60/70/75	✓	✓
1366×768@60	✓	✓
1280×1024@60	✓	✓
1600×1200@60	✓	✓
1920×1200@60	✓	✓
480i/576i	✓	✓
480p/576p	✓	✓
720p@50/60	✓	✓
1080i@50/60	✓	✓
1080p@24/50/60	✓	✓
3840×2160p@24/25/30	✓	✓
4096×2160p@24/50/60	✓	✓

## 9. ACRONYMS

ACRONYM	COMPLETE TERM
<b>CLI</b>	Command Line Interface
<b>DVI</b>	Digital Visual Interface
<b>EDID</b>	Extended Display Identification Data
<b>GUI</b>	Graphical User Interface
<b>HD</b>	High-Definition
<b>HDCP</b>	High-bandwidth Digital Content Protection
<b>HDMI</b>	High-Definition Multimedia Interface
<b>HTTP</b>	HyperText Transfer Protocol
<b>IP</b>	Internet Protocol
<b>IR</b>	Infrared
<b>LPCM</b>	Linear Pulse-Code Modulation
<b>PC</b>	Personal Computer
<b>S/PDIF</b>	Sony/Philips Digital Interface Format
<b>UHD</b>	Ultra-High-Definition
<b>USB</b>	Universal Serial Bus
<b>VGA</b>	Video Graphics Array (640×480@60Hz)
<b>WUXGA</b>	Wide Ultra Extended Graphics Array (1920×1200@60Hz)









**CYPRESS TECHNOLOGY CO., LTD.**

[www.cypress.com.tw](http://www.cypress.com.tw)