



CPLUS-1082VA

4K UHD+ 10×10 HDMI/HDBaseT Matrix
with AVLC & Audio Matrixing



Operation Manual

DISCLAIMERS

The information in this manual has been carefully checked and is believed to be accurate. Cypress Technology assumes no responsibility for any infringements of patents or other rights of third parties which may result from its use.

Cypress Technology assumes no responsibility for any inaccuracies that may be contained in this document. Cypress also makes no commitment to update or to keep current the information contained in this document.

Cypress Technology reserves the right to make improvements to this document and/or product at any time and without notice.

COPYRIGHT NOTICE

No part of this document may be reproduced, transmitted, transcribed, stored in a retrieval system, or any of its part translated into any language or computer file, in any form or by any means—electronic, mechanical, magnetic, optical, chemical, manual, or otherwise—without express written permission and consent from Cypress Technology.

© Copyright 2018 by Cypress Technology.

All Rights Reserved.

TRADEMARK ACKNOWLEDGMENTS

All products or service names mentioned in this document are trademarks of the companies with which they are associated.





SAFETY PRECAUTIONS

Please read all instructions before attempting to unpack, install or operate this equipment and before connecting the power supply. Please keep the following in mind as you unpack and install this equipment:

- Always follow basic safety precautions to reduce the risk of fire, electrical shock and injury to persons.
- To prevent fire or shock hazard, do not expose the unit to rain, moisture or install this product near water.
- Never spill liquid of any kind on or into this product.
- Never push an object of any kind into this product through any openings or empty slots in the unit, as you may damage parts inside the unit.
- Do not attach the power supply cabling to building surfaces.
- Use only the supplied power supply unit (PSU). Do not use the PSU if it is damaged.
- Do not allow anything to rest on the power cabling or allow any weight to be placed upon it or any person walk on it.
- To protect the unit from overheating, do not block any vents or openings in the unit housing that provide ventilation and allow for sufficient space for air to circulate around the unit.
- Please completely disconnect the power when the unit is not in use to avoid wasting electricity.

VERSION HISTORY

REVISION	DATE	SUMMARY OF CHANGE
VS1	22/11/18	Final technical review



CONTENTS

1. Introduction	1
2. Applications	2
3. Package Contents	2
4. System Requirements	2
5. Features	3
6. Operation Controls and Functions	5
6.1 Front Panel	5
6.2 Rear Panel.....	7
6.3 Side Panel	9
6.4 Remote Control.....	10
6.5 IR Cable Pinouts	11
6.6 OLED Menu	11
6.7 WebGUI Control.....	16
6.7.1 Video Switch Tab	18
6.7.2 Zone Audio Tab.....	25
6.7.3 Extended Audio Tab.....	27
6.7.4 CAT Audio Tab	29
6.7.5 HDMI Audio Tab	30
6.7.6 HDBaseT Audio Tab	32
6.7.7 Mixer Audio Tab	34
6.7.8 Zone A/V Pairing Tab.....	36
6.7.9 EDID Settings Tab	38
6.7.10 HDBaseT & H/W Info Tab	41
6.7.11 System Settings Tab	42
6.8 RS-232 Control	44
6.9 Telnet Control	44
6.10 RS-232 and Telnet Commands	45
6.10.1 Command Syntax.....	45
6.10.2 Real World Command Use	48
6.10.3 Full Command List.....	52



7. Connection Diagram	80
8. Specifications	81
8.1 Technical Specifications	81
8.2 Video Specifications	82
8.3 Audio Specifications	83
8.3.1 Analog Audio	83
8.3.2 Analog Audio Adjustments.....	83
8.3.3 Digital Audio	84
8.4 Cable Specifications	85
8.5 HDBaseT Features.....	86
9. Acronyms	87



1. INTRODUCTION

This 10×10 HDMI/HDBaseT Matrix supports routing and transmission of video (resolutions up to 4K@60Hz w/ HDMI 2.0 & HDCP 2.2) and audio (multi-channel digital/stereo analog) while providing flexible control via IR, RS-232, Telnet or WebGUI. As many as ten UHD sources may be routed to any of eight HDBaseT outputs (up to 100m at 1080p or up to 70m at 4K) or two HDMI outputs at resolutions up to 4K@60Hz (8-bit, Despite HDBaseT's 10.2Gbps bandwidth limitation, 4K UHD HDMI video sources, up to and including 4K@60Hz (4:4:4, 8-bit) as well as 10/12-bit sources with HDR, are able to be processed and extended by the use of AVLC (Adaptive Visually Lossless Compression) when needed. The HDMI outputs can also be set to mirror any of the HDBaseT outputs for local monitoring.

Beyond basic video routing, this unit also incorporates an independent audio matrix with 14 audio outputs and 10 audio inputs. Offering discrete audio routing, insertion and extraction, this product makes it easy to have multiple audio zones within your installation. Four additional analog audio outputs are available to provide stereo breakout audio from the associated HDBaseT output (LPCM 2.0 only). This unit also contains 3 independent audio mixers allowing for the addition of music or a voice over to existing audio and video (LPCM 2.0 only). This product supports the OAR (Optical Audio Return) feature, found on compatible HDBaseT receivers, allowing optical audio sources connected to those receivers to be sent back to the matrix unit for redirection. All HDMI and HDBaseT ports support up to 7.1 channel LPCM digital audio as well as Bitstream and HD Bitstream audio formats.

Integrated LAN support allows your 100BaseT network to be extended across compatible HDBaseT Receivers to smart TVs or projectors. Internally generated test patterns (up to 1080p) are provided to assist with setup, providing a simple way to verify both matrix and sink functionality. The PoH (Power over HDBaseT) functionality provides remote power to compatible HDBaseT Receivers, providing greater flexibility in your installations. Control is via front panel buttons with OLED menu, WebGUI, Telnet, RS-232 or IR remote.



2. APPLICATIONS

- Full audio/video matrix systems
- Residential AV matrix installations
- Commercial AV matrix installations
- Security systems
- University lecture hall systems
- Retail installation system

3. PACKAGE CONTENTS

- 1×HDMI/Audio over HDBaseT Matrix
- 2×24V/6.25A DC Power Adapter
- 2×Power Cord
- 2×3.5mm to IR Extender Cable
- 2×3.5mm to IR Blaster Cable
- 1×Remote Control (CR-163)
- 1×Rackmount Ears (Set of 2)
- 1×Detachable Handles (Set of 2)
- 1×Operation Manual

4. SYSTEM REQUIREMENTS

- HDMI source equipment such as media players, video game consoles or set-top boxes.
- HDMI receiving equipment such as HDTVs, monitors or audio amplifiers.
- HDBaseT receivers equipped with AVLC (Adaptive Visually Lossless Compression) and OAR (Optical Audio Return) support are strongly recommended.
- The use of industry standard Cat.6, Cat.6a or Cat.7 cable is highly recommended.
- The use of "Premium High Speed HDMI" cables is highly recommended. Compatible display equipment is also required.

5. FEATURES

- HDMI with HDR & 4K@60Hz support, DVI 1.0 compatible
- HDCP 1.x and HDCP 2.2 compliant
- Routes ten HDMI sources to ten displays using eight HDBaseT outputs and two independent or mirrored HDMI outputs
- Supports up to 4K UHD (18Gbps, 4K@60Hz 4:4:4, 8-bit) video input and output
- Supports Deep Color input and output up to 12-bit
- Supports 10-bit and 12-bit HDR bypass
- Integrated AVLC (Adaptive Visually Lossless Compression) activates when the bandwidth requirements of the source are beyond 10.2Gbps (340MHz) allowing for support of sources up to 18Gbps (600MHz) with no loss of visual quality via compatible HDBaseT Receivers
- Supports automatic 4K@60Hz (4:4:4) to 4K@60Hz (4:2:0) and 10/12-bit color to 8-bit color conversion when connected to non-AVLC HDBaseT Receivers
- Supports automatic 4K (4:4:4) to 1080p scaling over the HDBaseT outputs when connected to displays that can't support 4K resolutions
- Supported HDBaseT feature set: HD Video & Audio, 100BaseT Ethernet, 48V PoH, and Control (Bidirectional IR/RS-232 pass through)
- All HDBaseT outputs support OAR (Optical Audio Return)
- 4K signals can be transmitted up to 70m via Cat.5e/6 and up to 100m via Cat.6a/7
- Supports pass-through of these standard digital audio formats via HDMI/HDBaseT: LPCM 2.0/5.1/7.1, Bitstream, and HD Bitstream
- Supports audio matrix functionality enabling full audio management of the system including HDBaseT audio selection, fully independent audio-only zones and HDMI audio embedding and de-embedding (LPCM only)
- Advanced DAC (Digital to Analog Conversion) and ADC (Analog to Digital Conversion) for audio integration
- Supports integrated audio over CAT inputs and outputs for transmission up to 300m



- Supports volume, treble, bass, and audio delay for lip-sync (up to 230ms) on analog audio outputs and mute on all outputs
- Audio mixer functionality (three mixers in total)
- Advanced internal and external EDID management with 4 sets of configurable EDID settings
- Internal test pattern generation (up to 1080p) for self and sink testing
- 2U rack mounted design
- Control via front panel buttons with OLED menu, Ethernet (Telnet & WebGUI), RS-232, and IR remote

6. OPERATION CONTROLS AND FUNCTIONS

6.1 Front Panel

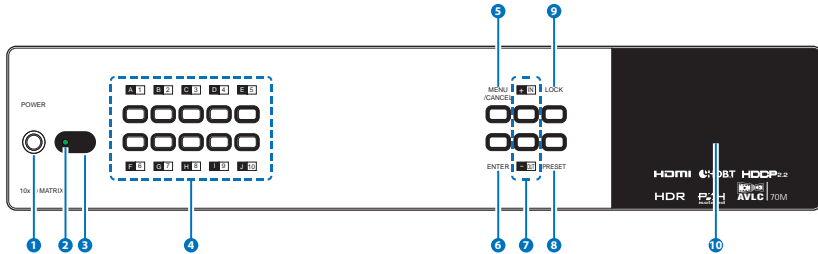

- 1 POWER BUTTON:** Press this button to power the unit on or place it into stand-by mode.

Note: Network functionality and PoH (if the second power supply is connected) remain active when the unit is in stand-by mode.

- 2 POWER LED:** This LED will illuminate GREEN to indicate the unit is on and receiving power. When the unit is in stand-by mode the LED will illuminate RED.

- 3 IR WINDOW:** Accepts IR signals from the included IR remote for control of this unit only.

- 4 OUTPUT A~J & INPUT/NUMBER 1~10 BUTTONS:** Press the "OUT" button to enter output selection mode. Next, press the output keys (A~J) of the outputs you wish to route a source to (they will flash to indicate selection). Next, press the "IN" key followed by the input (1~10) you wish to route to the selected outputs. Finally, press "ENTER" to confirm your selection and execute the routing change.

For example, if you wish to display input 1 on outputs A~D then the following sequence of button presses should be performed:

OUT → A, B, C, D → IN → 1 → ENTER

Note: When directly entering Ethernet address information into the unit all 10 buttons are used to represent the numbers from 0 to 9 (button 10 = 0) to make number entry more streamlined.

- 5 MENU/CANCEL BUTTON:** Press to enter the OLED menu, or to back out from menu items.



6 ENTER BUTTON: Press to confirm a selection or to go deeper into a menu item.

7 +/IN BUTTONS: Within the menu, this button moves you up within the menu tree. Otherwise, in routing mode, this button allows you to make your input source selection.

-/OUT BUTTONS: Within the menu, this button moves you down within the menu tree. Otherwise, this button starts routing mode and allows you to begin your output destination selections

8 PRESET BUTTON: Press this button to recall saved presets. Press the "Preset" button followed by a number button and the "Enter" button to recall the stored preset assigned to that number. A maximum of 8 presets can be stored in the unit. Presets are created and stored via the WebGUI.

Note: Please refer to section 6.7.1 for advanced preset settings.

9 LOCK BUTTON: Press and hold this button for 3 seconds to lock/unlock all buttons on the front panel. The OLED will display an "L" in the upper right corner to indicate the front panel is locked.

10 OLED WINDOW: Displays the unit's menu, settings and information.

6.2 Rear Panel

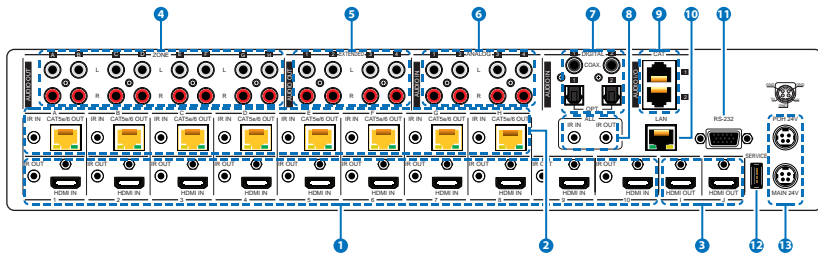

- HDMI IN & IR OUT 1~10 PORTS:** Connect up to 10 source devices to the HDMI ports using appropriate quality HDMI cables. Input source devices include Blu-ray players, set-top boxes, game systems and so on. Attach IR blasters to the IR Out ports to transmit the IR signals received from connected HDBaseT Receivers.

Note: IR signal routing follows the HDMI signal routing.

- CAT5e/6 OUT & IR IN A~H PORTS:** Connect to compatible HDBaseT Receivers with Cat.5e/6/7 cable for transmission of all data signals. In order for an IR signal to be transmitted along with the HDMI signal an IR extender must be connected to the associated IR In port. IR signals coming back from the connected HDBaseT receiver can be used to control the matrix remotely and will also be broadcast from IR blasters connected to the appropriate IR Out/ All IR outputs. 48V PoH will also be supplied if the 2nd (POH 24V) power supply has been connected to the unit.

Note: 4K signals with 10/12-bit HDR (High Dynamic Range) color are not supported by standard HDBaseT Receivers and will be automatically converted to 8-bit color. In order to properly extend these signals an AVLC supporting HDBaseT Receiver must be used. 4K (4:4:4) sources will be automatically scaled to 1080p if the connected display can't support 4K.

- HDMI OUT I~J PORTS:** Connect up to 2 HDMI displays using these HDMI output ports. These two HDMI ports can be either independent high bandwidth (18Gbps) outputs, or they can be configured to mirror two of the HDBaseT outputs for local monitoring or recording purposes.
- ZONE AUDIO OUT A~H PORTS:** Eight sets of stereo analog audio outputs. These audio ports are capable of independently



outputting audio routed from any audio source within the matrix. Audio mixing, treble, bass, volume and audio delay adjustments can be set in the WebGUI.

Note: LPCM 2.0 or analog stereo sources only.

- 5 EXTENDED AUDIO OUT 1~4 PORTS:** Four sets of stereo analog audio outputs. These audio ports are capable of independently outputting audio routed from any audio source within the matrix. Audio mixing, treble, bass, volume and audio delay adjustments can be set in the WebGUI.

Note: LPCM 2.0 or analog stereo sources only.

- 6 ANALOG AUDIO IN 1~4 PORTS:** Accepts unbalanced analog audio from sources such as DVD players, PCs, MP3 players, etc. These audio sources can be paired with the video from any HDMI input or can be mixed with another audio source. Audio mixing can be set in the WebGUI.

- 7 DIGITAL AUDIO IN 1~2 PORTS:** Accepts digital audio (LPCM 2.0 only) from sources such as Blu-ray players, game systems, PCs, etc. These audio sources can be paired with the video from any HDMI input or can be mixed with another audio source. Audio mixing can be set in the WebGUI.

- 8 IR IN (ALL) PORT:** Connect an IR extender to this port for IR signal reception. All IR signals received will be broadcast by all IR blasters connected to the matrix or connected HDBaseT receivers. Please ensure that the remote being used is within direct line-of-sight of the IR extender.

IR OUT (ALL) PORT: Connect an IR Blaster to this port to broadcast IR signals. All IR signals received by any IR extenders connected to the matrix or HDBaseT receivers will be broadcast. Please place the IR Blaster in direct line-of-sight of the equipment to be controlled.

- 9 CAT AUDIO I/O 1~2 PORTS:** Can send/receive audio to/from connected compatible CAT Audio devices via standard Cat.5e cable. This connection allows audio to be sent to/from the matrix over greater distances than would normally be possible via standard cables.

Note: 48kHz audio can be transmitted up to 300m, 96kHz audio can be transmitted up to 150m and 192kHz audio can be transmitted up to 100m.

- 10 LAN PORT:** Connect to an active Ethernet network to allow for Telnet and WebGUI control of the matrix as well as to share the network with connected compatible LAN equipped HDBaseT receivers. This allows for any Ethernet equipped device (e.g. a smart TV or game console) connected to the LAN port of a receiver to share the network/Internet access.
- 11 RS-232 PORT:** Connect directly to your PC/laptop to send RS-232 commands to control the unit.
- 12 SERVICE PORT:** Used for firmware service updates in the field via USB thumb drive. After connecting a USB thumb drive containing appropriate firmware, please navigate via the front panel menu to: 5-Firmware → 2-Update → YES to begin the firmware update.
- 13 MAIN 24V & PoH 24V PORTS:** Plug one of the 24V power supplies (included in the package) into the port marked “MAIN 24V” to power the matrix unit. If you wish to connect PoH powered HDBaseT receivers to the matrix, please plug the second 24V power supply into the “POH 24V” port. This will allow the matrix to provide 48V PoH to all connected HDBaseT receivers.

Note: The 48V PoH function is designed to power compatible Receiver units only. Non-PoH Receivers will need their own power supply. Other Receiver brands may not be compatible.

6.3 Side Panel

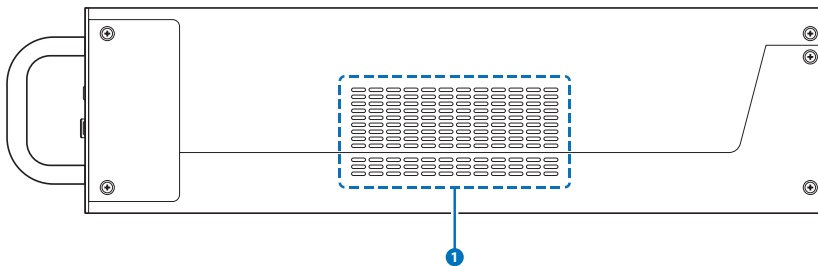

- 1 VENT FAN:** These vents are for are for air ventilation. Please allow adequate space around the unit for air circulation.

Warning: DO NOT block the airflow from these vents or cover them with any objects.

6.4 Remote Control

- 1 **POWER BUTTON:** Press to power the unit on or place it into stand-by mode.
- 2 **LOCK BUTTON:** Press to lock/unlock the front panel of the matrix unit.
- 3 **MUTE BUTTON:** Mutes Zone Audio outputs.
Note: HDBaseT audio can only be muted when an independent, non-HDMI, audio source has been routed to the output.
- 4 **IN 1~10, OUT A~J & PATTERN BUTTONS:**

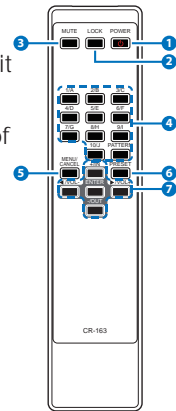

[Local matrix control] When controlling the unit directly, input and output selection behaves the same as the front panel buttons with the “Pattern” button acting as an additional test pattern source.

Note: Refer to section 6.1 for more details.

[Zone A/V Pairing] When controlling the unit via an HDBaseT receiver in a remote location, pressing buttons 1~10 will switch to the A/V source assigned to the number depending on your current zone. These assignments are configured via the WebGUI.

Note: Refer to section 6.7.8 for more details.

- 5 **MENU/CANCEL BUTTON:** Press the “MENU/CANCEL” button to enter the OLED menu, or to back out from menu items.
- 6 **PRESET BUTTON:** Recall matrix presets. Press the “Preset” button followed by a number button to recall the stored preset assigned to that number. The presets are configured within the WebGUI.
- 7 **+ / IN BUTTON:** Within the menu, this button moves you up within the menu tree. Otherwise, in routing mode, this button allows you to make your input source selection.

- / OUT BUTTON: Within the menu, this button moves you down within the menu tree. Otherwise, this button starts routing mode and allows you to begin your output destination selections.

◀ / VOL- & ▶ / VOL+ BUTTONS: Adjusts the volume of zone audio.

ENTER BUTTON: Press this button to confirm selections.

Note: This remote control is designed for the full family of matrix products. Some functions are not available on all units.

6.5 IR Cable Pinouts

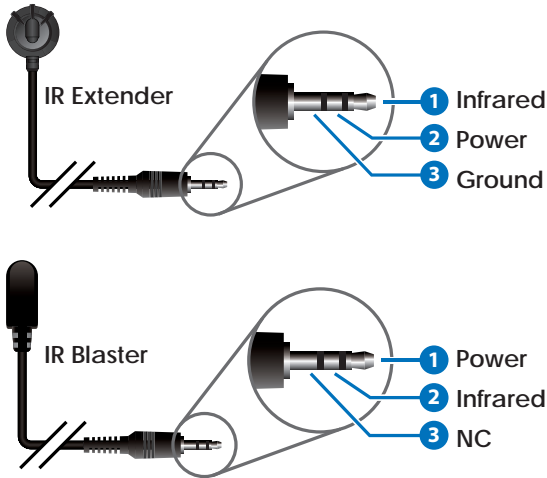

6.6 OLED Menu

All basic functions of this unit can be controlled by using the front panel's OLED menu which is activated by pressing the MENU/CANCEL button on the front of the unit. Use the + (PLUS), - (MINUS), and ENTER buttons to navigate the menu. Press the MENU/CANCEL button to back out from any menu item and then press it again to close the menu. The number buttons may also be used to quickly navigate the numbered menu items.

When not in the menu, the model name and IP address of the unit will be displayed. Additional networking information (netmask and gateway) can be displayed by repeatedly pressing the "+" or "-" buttons on the front panel or remote control unit.

MAIN MENU
1-EDID
2-Network
3-HDMI Mirroring
4-Factory Default
5-Firmware
6-Miscellaneous

The individual functions of the OLED menu will be introduced in the following section. Items marked in **BOLD** are the factory default settings.

1-EDID	
2ND LEVEL	3RD LEVEL
1-EDID Mode	ALL
	Independent
2-EDID Select (All or 1-10)	1-FHD/2CH
	2-FHD/Mch
	3-UHD/2ch
	4-UHD/Mch
	5-UHD+/2ch
	6-UHD+/Mch
	7-Sink A
	8-Sink B
	9-Sink C
	10-Sink D
	11-Sink E
	12-Sink F
	13-Sink G
	14-Sink H
15-Sink I	
16-Sink J	

1-EDID	
2ND LEVEL	3RD LEVEL
2-EDID Select (All or 1-10)	17-User 1
	18-User 2
	19-User 3
	20-User 4

- 1) **EDID Mode:** Select the EDID mode of the unit between All or Independent. "All" mode assigns the same EDID to all inputs. "Independent" mode allows each input to have a different EDID.
- 2) **EDID Select:** In "All" mode, select the EDID to use with all inputs. In "Independent" mode, press the numbered button of the input to adjust, and then select the EDID to use with that input. After making a selection press the "Enter" button to save the change.

2-NETWORK	
2ND LEVEL	3RD LEVEL
1-Link Status	[Displays current link status]
2-IP Address	[Displays current IP address]
3-Subnet Mask	[Displays current subnet mask]
4-Gateway Address	[Displays current gateway address]
5-MAC Address	[Displays MAC address]
6-DHCP Mode	On
	OFF

- 1) **Link Status:** Displays the current Ethernet link status.
- 2) **IP Address:** When DHCP is off, the IP address can be set here. The digit to edit is changed by using the +/- buttons and will flash when selected. Press the number buttons to enter a new number. Press the "Enter" button to store the current number segment and move to the next segment.
Note: When DHCP is enabled, the IP address will be assigned automatically and can not be edited.
- 3) **Subnet Mask:** When DHCP is off, the subnet mask can be set here. The digit to edit is changed by using the +/- buttons and will flash



when selected. Press the number buttons to enter a new number. Press the "Enter" button to store the current number segment and move to the next segment.

Note: When DHCP is enabled, the subnet mask will be assigned automatically and can not be edited.

- 4) **Gateway Address:** When DHCP is off, the gateway address can be set here. The digit to edit is changed by using the +/- buttons and will flash when selected. Press the number buttons to enter a new number. Press the "Enter" button to store the current number segment and move to the next segment.

Note: When DHCP is enabled, the gateway address will be assigned automatically and can not be edited.

- 5) **MAC Address:** Displays the unit's MAC address.
- 6) **DHCP Mode:** Enable or disable DHCP mode. When enabled, all IP address information will be assigned automatically by the local DHCP server. When disabled, the IP address must be set manually.

Note: The unit's default static IP address is 192.168.1.50.

3-HDMI MIRRORING	
2ND LEVEL	3RD LEVEL
Output I	A ~ H
	NONE
Output J	A ~ H
	NONE

- 1) **Output I & J Mirroring:** Enable or disable output mirroring for HDMI outputs I and J. When either output is set to mirror one of the 8 HDBaseT outputs it will display the same content as the mirrored output. Press the "Enter" button to enter selection mode and use the +/- buttons to switch between HDMI outputs I and J. To select an HDBaseT output to mirror, press the associated output letter button. To disable mirroring for the selected output, select "I" or "J" as the source. Press the "Enter" button to confirm the selection.

4-FACTORY DEFAULT	
2ND LEVEL	3RD LEVEL
Factory Reset?	Yes
	NO

- 1) **Factory Reset:** Selecting "Yes" will perform a factory reset and return the unit to its factory default state. After the reset is complete, the unit will reboot automatically.

5-FIRMWARE	
2ND LEVEL	3RD LEVEL
1-Version	[Displays current version]
2-Update	Yes
	NO

- 1) **Version:** Displays the unit's current firmware version.
- 2) **Update:** Provides a way to update the unit's firmware. To begin the firmware update process, select "Yes" followed by pressing the "Enter" button. Next, insert a USB thumb drive, with a valid firmware file (*.bin format) in the root directory, into the unit's USB service port and the update will begin automatically. The unit will automatically reboot to complete the update process.

6-MISCELLANEOUS	
2ND LEVEL	3RD LEVEL
1-IR Remote Channel	0 ~ 15 [0]
2-Discrete IR Address	[Displays current status]
3-System Baud Rate	[Displays current baud rate]

- 1) **IR Remote Channel:** Select the IR remote channel that the unit will accept signals on.
- 2) **Discrete IR Address:** Displays the current discrete IR address state.
- 3) **System Baud Rate:** Displays the unit's current serial control baud rate.

6.7 WebGUI Control

- **Device Discovery**

Please obtain the “Device Discovery” software from your authorized dealer and save it in a directory where you can easily find it.

Connect the unit and your PC/Laptop to the same active network and execute the “Device Discovery” software. Click on “Find Devices on Network” and a list of devices connected to the local network will show up indicating their current IP address.

Note: The unit’s default IP address is 192.168.1.50.



Find Devices on Network			
Product Name	Description	IP Address	MAC Address

By clicking on one of the listed devices you will be presented with the network details of that particular device.

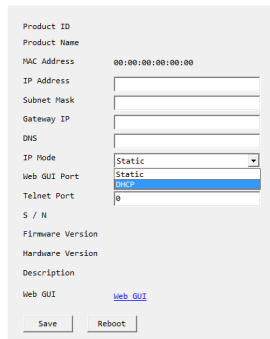

Product ID
 Product Name
 MAC Address 00:00:00:00:00
 IP Address
 Subnet Mask
 Gateway IP
 DNS
 IP Mode Static
 Web GUI Port Static
 Telnet Port 0
 S / N
 Firmware Version
 Hardware Version
 Description
 Web GUI [Web GUI](#)
 Save Reboot

- 1) **IP Mode:** If you choose, you can alter the static IP network settings for the device, or switch the unit into DHCP mode to automatically obtain proper network settings from a local DHCP server. To switch to DHCP mode, please select DHCP from the IP mode drop-down, then click “Save” followed by “Reboot”.
- 2) **WebGUI Hotkey:** Once you are satisfied with the network settings, you may use them to connect via Telnet or WebGUI. The network information window provides a convenient link to launch the WebGUI directly.

- **WebGUI Overview**

After connecting to the WebGUI's address in a web browser, the login screen will appear. Please enter the appropriate user name and password then click "Submit" to log in.

Note: The default user name and password is "admin".

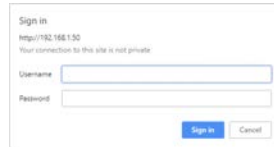

On the left side of the browser you will see the following menu tabs where all primary functions of the unit are controllable via the built in WebGUI. The individual functions will be introduced in the following sections.

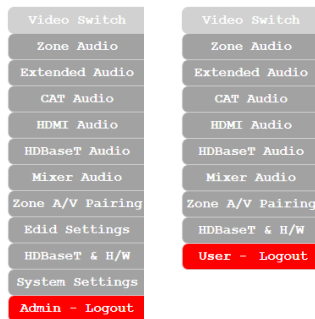

Clicking the red "Logout" tab will automatically log the currently connected user out of the WebGUI and return to login page.

Note: The "Admin" login has full access to operate and control the unit, while the "User" login has access to fewer menus and limited control over certain functions.

6.7.1 Video Switch Tab

This tab provides video routing settings including HDCP and test pattern configuration.

1) Output and Input Routing

To begin assigning a new video route, please click the button of the HDBaseT output you wish to send video to and then click on the button of the preferred HDMI input port or Pattern. If desired, you may select more than one output prior to selecting the input. As you select each button they will change their color to orange. The new route will become active immediately and the routing information displayed on the buttons will change accordingly.

Note: If you need to route an input to multiple outputs, please select all of the appropriate output buttons before selecting the input port.

The screenshot displays the 'Video Switch' configuration page. On the left is a navigation menu with options: Zone Audio, Extended Audio, CAT Audio, HDMI Audio, HDBaseT Audio, Mixer Audio, Zone A/V Pairing, Edid Settings, HDBaseT & H/W, System Settings, and Admin - Logout (highlighted in red). The main area is titled 'Switch' and is divided into two columns: 'Output' and 'Input'.

Output (HDBaseT):

- A** Display A from HDMI_In 1 Connected (Orange button)
- B** Display B from HDMI_In 1 Connected (Orange button)
- C** Display C from HDMI_In 1 No Signal (White button)
- D** Display D from HDMI_In 1 No Signal (White button)
- E** Display E from HDMI_In 1 No Signal (White button)
- F** Display F from HDMI_In 1 No Signal (White button)
- G** Display G from HDMI_In 1 No Signal (White button)
- H** Display H from HDMI_In 1 No Signal (White button)
- I** Display I from HDMI_In 1 No Signal Independent (White button)
- J** Display J from HDMI_In 1 Connected Independent (White button)

Input (Internal):

- Pattern** (White button)
- HDMI**
 - 1** HDMI_In 1 Connected (Orange button)
 - 2** HDMI_In 2 Connected (White button)
 - 3** HDMI_In 3 Connected (White button)
 - 4** HDMI_In 4 No Signal (White button)
 - 5** HDMI_In 5 No Signal (White button)
 - 6** HDMI_In 6 No Signal (White button)
 - 7** HDMI_In 7 No Signal (White button)
 - 8** HDMI_In 8 No Signal (White button)
 - 9** HDMI_In 9 No Signal (White button)
 - 10** HDMI_In 10 No Signal (White button)

2) Output and Input Naming

All inputs and outputs can be renamed as required. To rename the HDBaseT output ports and HDMI input ports please click the appropriate "Edit" icon (⚙️). Click the "Save" button to confirm the name change.

Note: Blank spaces are not allowed in names.

The screenshot displays the 'Switch' configuration page. On the left is a sidebar menu with options: Video Switch, Zone Audio, Extended Audio, CAT Audio, HDMI Audio, HDBaseT Audio, Mixer Audio, Zone A/V Pairing, Edid Settings, HDBaseT & H/W, System Settings, and Admin - Logout. The main area is titled 'Switch' and contains two columns: 'Output HDBaseT' and 'Input Internal'. The 'Output HDBaseT' column lists displays A through J, each with its source (e.g., 'from HDMI_In 1') and status (e.g., 'Connected' or 'No Signal'). A red arrow points from the gear icon next to 'Display A' to an 'Output Edit' dialog box. The dialog box has a title 'Set Output A Name - Display A' and a text input field containing 'Display A'. Below this are sections for 'TIMING' (set to '150060'), 'Test Pattern Color Control' (set to 'Color90'), and a 'Save' button. The 'Input Internal' column lists HDMI inputs 1 through 10, with their respective sources and statuses.

3) HDMI Output Settings

The two HDMI outputs (port I & port J) can be used for normal source routing (listed as “Independent” within the WebGUI) and mirroring (listed as “Mirror” within the WebGUI) for local monitoring purposes or zone monitoring (e.g. The HDBaseT output connects to a TV in a remote zone the local HDMI connection goes into an AVR).

Click the “Edit” icon (⚙️) to open a sub-window which allows changing the HDMI output mode between “Independent” and “Mirror”. When an HDMI port is in “Mirror” mode, select the input to mirror using the dropdown to the right.

Note: Only HDBaseT outputs may be selected as Mirror sources.

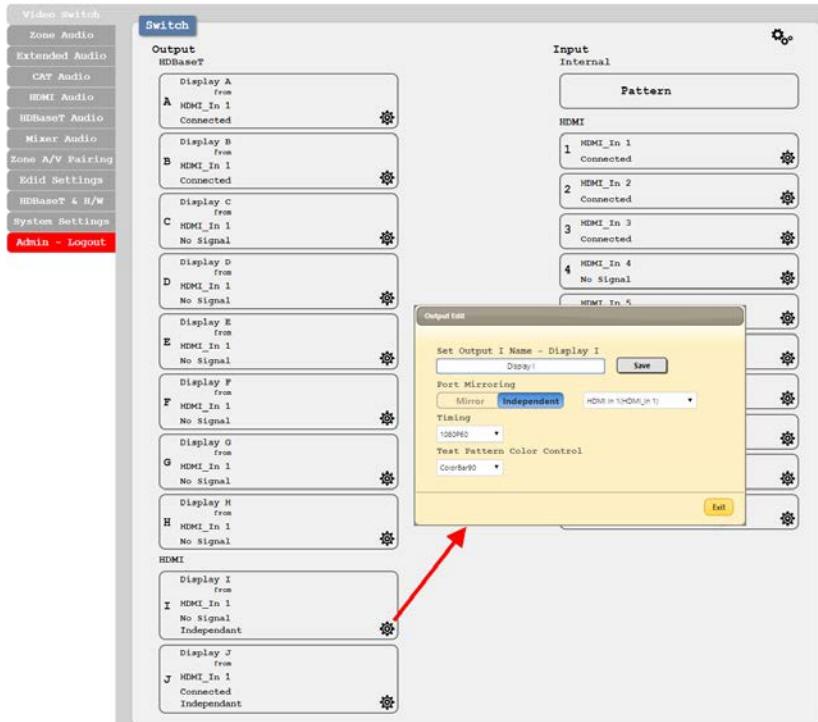

4) Internal Test Pattern

This advanced matrix system comes with an internal test pattern generation feature which can be used to test connected sink device functionality or be used as a self-test. This is a useful tool for installation engineers to troubleshoot potential issues between the matrix and connected devices.

This can also be used as a video source for any connected “audio only” sources in cases where only a TV is available for audio reproduction and it requires an active video source in order for the audio to be heard.

Note: The test pattern is only active when the “Pattern” input is routed to the specified output.

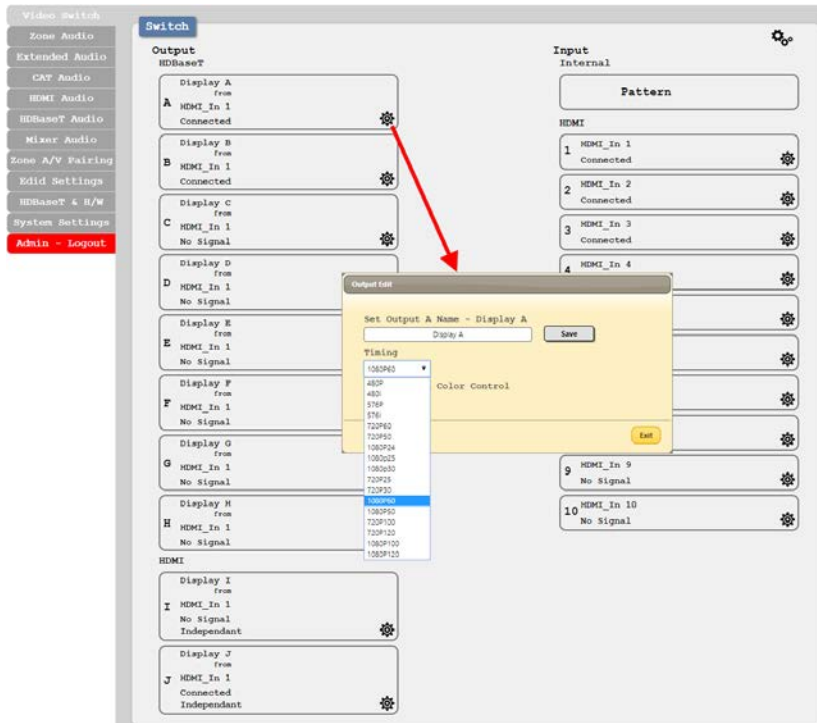

- **Timing:** Test patterns can be generated on either the HDMI or HDBaseT outputs at the following standard resolutions with a variety of refresh rates: 480i/p, 576i/p, 720p, 1080p, 4K. Test

pattern output does not enable HDCP.

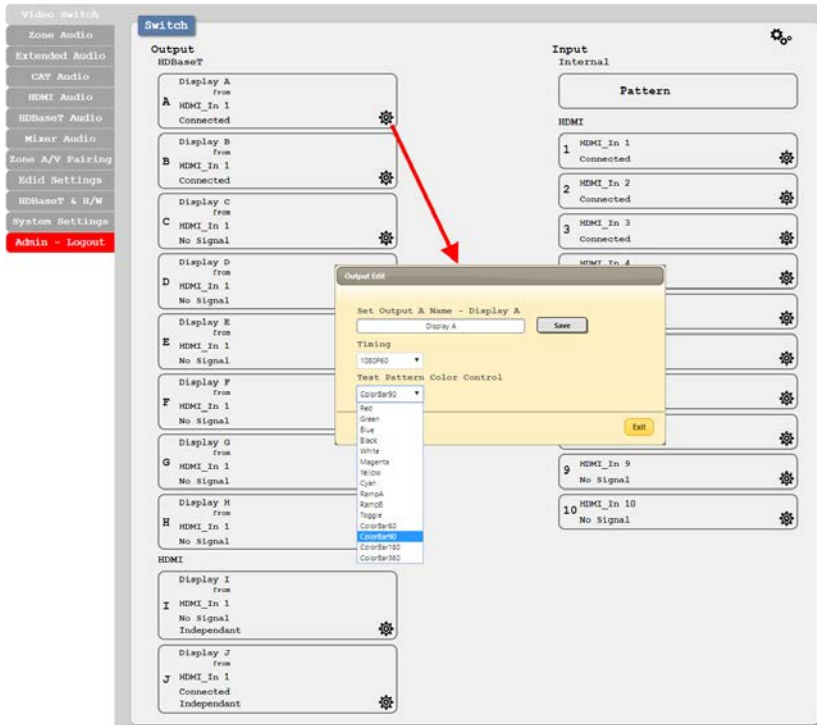

- Test Pattern Color Control:** The test pattern type can be changed to any one of sixteen different options. The patterns include full screen colors as well as a selection of other basic patterns.

5) Preset Settings

This matrix can store up to eight video and audio routing presets. Presets can be utilized to store multiple different routing states in advance for rapid, hassle-free, recall. To store, recall or view a preset, click the “Preset” icon (⚙️) in the upper right corner of the tab to open the Preset configuration window.

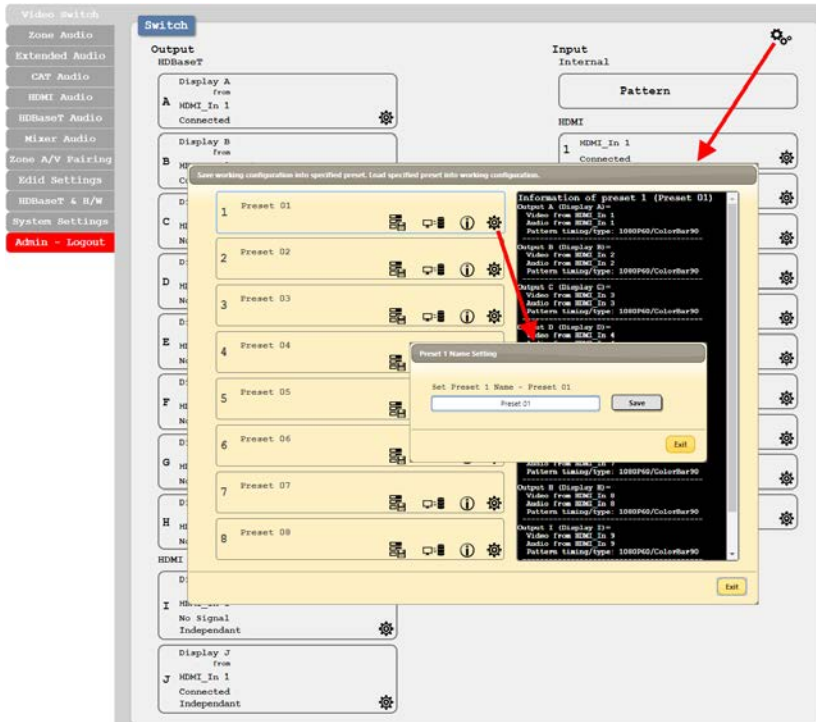

- **Save:** Click the “Save” icon (💾) next to the preferred Preset to store the current matrix configuration into that preset. After updating the preset, the information box to the right will show the new routing details.
- **Load:** When you wish to load a previously stored setting, please click the “Load” icon (📄) associated with the Preset you wish to load. The Preset will load immediately upon clicking the icon.
- **Information:** Click the “Information” icon (ℹ️) next to the preferred Preset to view the current contents of the specified



Preset in the information box to the right.

- **Rename:** Click the “Edit” icon (⚙️) to open the rename sub-window. After entering a new name, click the “Save” button to confirm the name change.

Note: Blank spaces are not allowed in names.

6.7.2 Zone Audio Tab

This advanced matrix offers a complete audio routing function. The Zone Audio ports offer analog audio breakaway capability. The audio source, treble, bass, volume and audio delay adjustments can be set on this tab.

1) Output and Input Routing

Click the buttons from left to right to choose each output's audio source. Once the new source has been selected, the change will happen immediately. Audio source options include HDMI, Optical, Coaxial, Analog, OAR, Audio CAT and Mixer.

The screenshot displays the 'Audio - Zone' configuration page. On the left is a navigation menu with options: Video Switch, Zone Audio, Extended Audio, CAT Audio, HDMI Audio, SDBaseT Audio, Mixer Audio, Zone A/V Pairing, Edid Settings, SDBaseT & H/W, System Settings, and Admin - Logout. The main area is titled 'Audio - Zone' and 'Audio Output'. It lists eight audio outputs (A through H) with their respective sources and volume controls. Output A is selected and shows 'HDMI_In 1' as the source. To the right, there are two columns: 'Audio Source' and 'Source Port'. The 'Audio Source' column includes buttons for HDMI, Optical, Coaxial, Analog, OAR, Audio CAT, and Mixer. The 'Source Port' column includes buttons for HDMI 1 through HDMI 10. An arrow points from the 'HDMI' source button to the 'HDMI 1' port button.

Audio Output	Audio Source	Source Port
A: ZoneLineOut A from HDMI_In 1	HDMI	HDMI 1, HDMI 6
B: ZoneLineOut B from OAR_In B	Optical	HDMI 2, HDMI 7
C: ZoneLineOut C from OAR_In C	Coaxial	HDMI 3, HDMI 8
D: ZoneLineOut D from OAR_In D	Analog	HDMI 4, HDMI 9
E: ZoneLineOut E from OAR_In E	OAR	HDMI 5, HDMI 10
F: ZoneLineOut F from OAR_In F	Audio CAT	
G: ZoneLineOut G from OAR_In G	Mixer	
H: ZoneLineOut H from OAR_In H		

2) Audio Output Settings

Click the "Edit" icon (⚙️) to change the following settings:

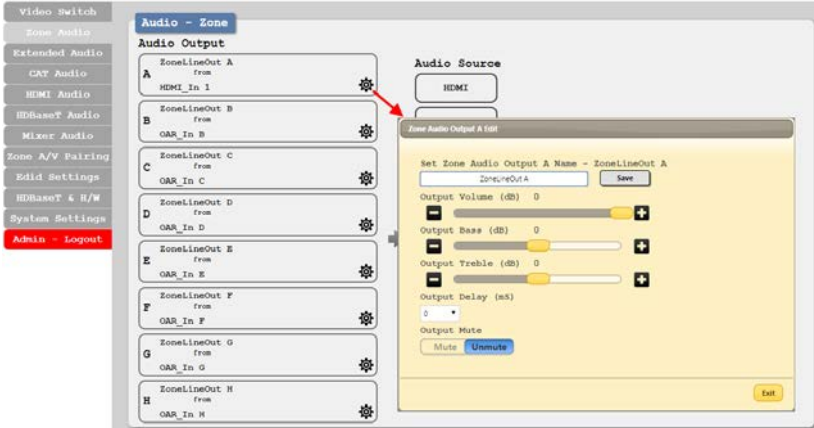

- **Output Name:** The Zone Audio outputs can be renamed here.
- **Output Volume:** Adjustable from -100dB to +12dB.
- **Output Bass:** Adjustable from -12dB to +12dB.
- **Output Treble:** Adjustable from -12dB to +12dB.
- **Output Delay:** Adjustable from 0 to 230ms.
- **Output Mute:** Mute may be turned on or off.

6.7.3 Extended Audio Tab

The Extended Audio ports offer additional analog audio breakaway capability. The audio source, treble, bass, volume and audio delay adjustments can be set on this tab.

1) Output and Input Routing

Click the buttons from left to right to choose each output's audio source. Once the new source has been selected, the change will happen immediately. Audio source options include HDMI, Optical, Coaxial, Analog, OAR, Audio CAT and Mixer.

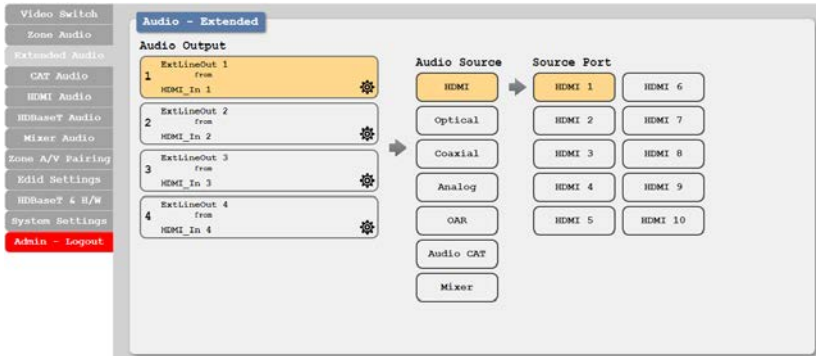

2) Extended Audio Output Settings

Click the “Edit” icon (⚙️) to change the following settings:

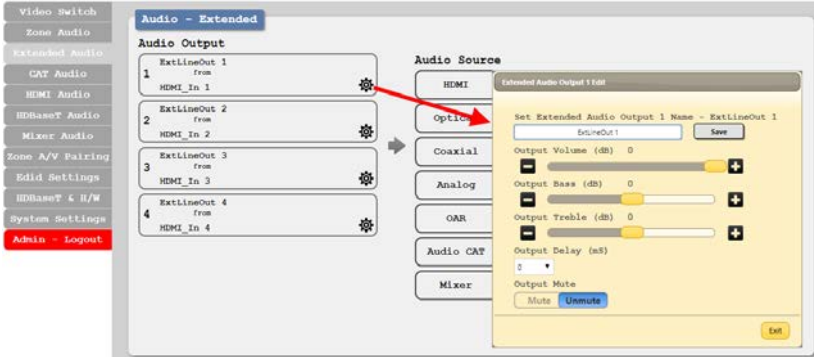

- **Output Name:** The Extended Audio outputs can be renamed here.
- **Output Volume:** Adjustable from -100dB to +12dB.
- **Output Bass:** Adjustable from -12dB to +12dB.
- **Output Treble:** Adjustable from -12dB to +12dB.
- **Output Delay:** Adjustable from 0 to 230ms.
- **Output Mute:** Mute may be turned on or off.

6.7.4 CAT Audio Tab

Connecting compatible CAT Audio receivers allows the matrix to both send and receive audio over distances up to 300m. The audio source and mute settings of audio being sent from the matrix to a receiver can be set on this tab.

1) Output and Input Routing

Click the buttons from left to right to choose each output's audio source. Once the new source has been selected, the change will happen immediately. Audio source options include HDMI, Optical, Coaxial, Analog, OAR, Audio CAT and Mixer.

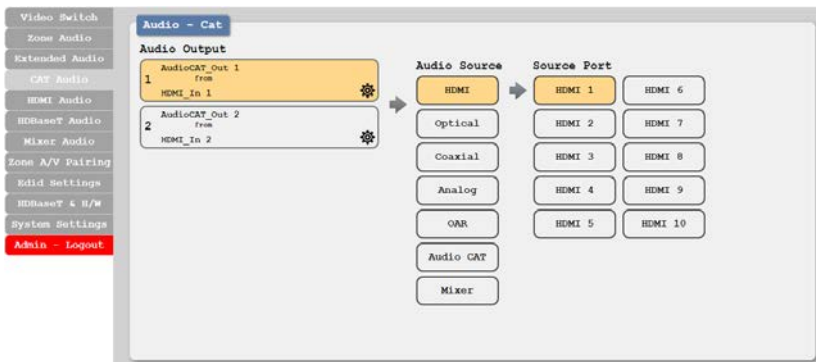

2) CAT Audio Output Settings

Click the "Edit" icon (⚙️) to change the following settings:

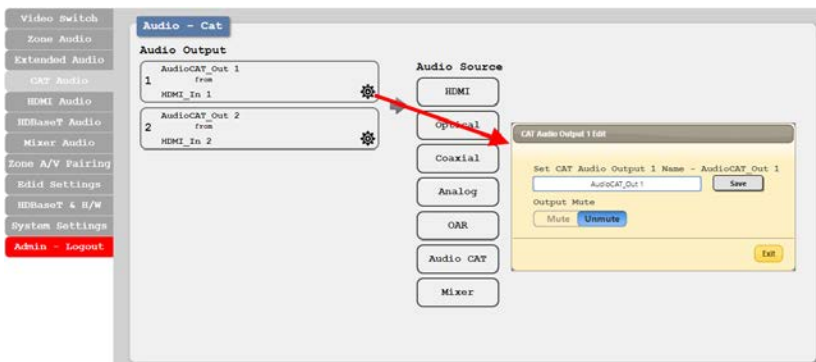

- **Output Name:** The CAT Audio outputs can be renamed here.
- **Output Mute:** Mute may be turned on or off.

6.7.5 HDMI Audio Tab

The audio routed to the two HDMI outputs (ports: I & J) and their associated settings are adjusted on this tab.

1) Output and Input Routing

Click the buttons from left to right to choose each output's audio source. Once the new source has been selected, the change will happen immediately. Audio source options include HDMI, Optical, Coaxial, Analog, OAR, Audio CAT and Mixer.

Note: Manually selecting a new audio source will automatically disable the "Follow Video" setting.

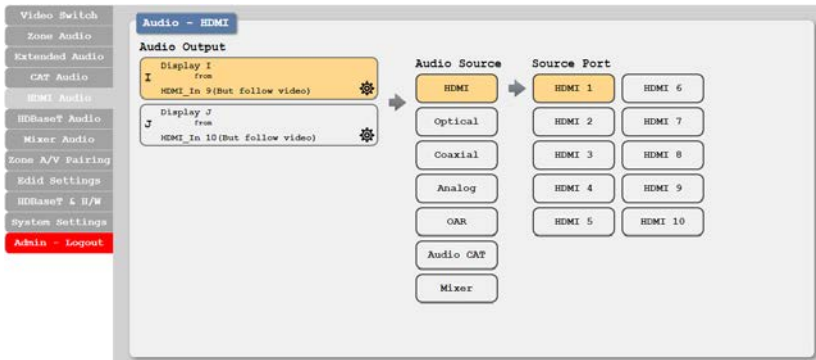

2) HDMI Audio Output Settings

Click the "Edit" icon (⚙️) to change the following settings:

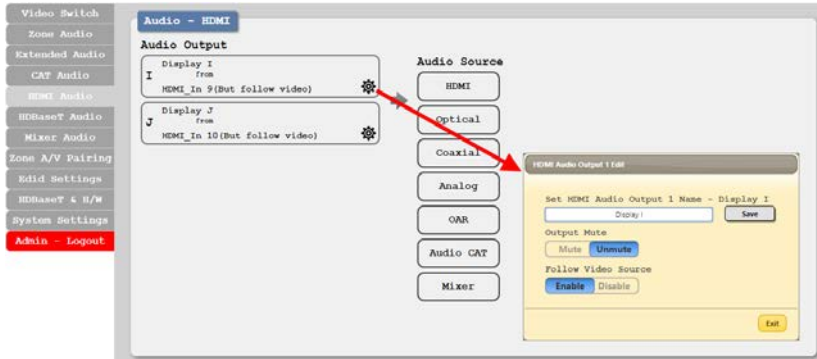

- **Output Name:** The HDMI Audio outputs can be renamed here.
- **Output Mute:** Mute may be turned on or off.
- **Follow Video Source:** Clicking the selection bar switches between Enable (follow video) and Disable (don't follow video).

6.7.6 HDBaseT Audio Tab

The audio routed to the eight HDBaseT outputs (ports: A-H) and their associated settings are adjusted on this tab.

1) Output and Input Routing

Click the buttons from left to right to choose each output's audio source. Once the new source has been selected, the change will happen immediately. Audio source options include HDMI, Optical, Coaxial, Analog, OAR, Audio CAT and Mixer.

Note: Manually selecting a new audio source will automatically disable the "Follow Video" setting.

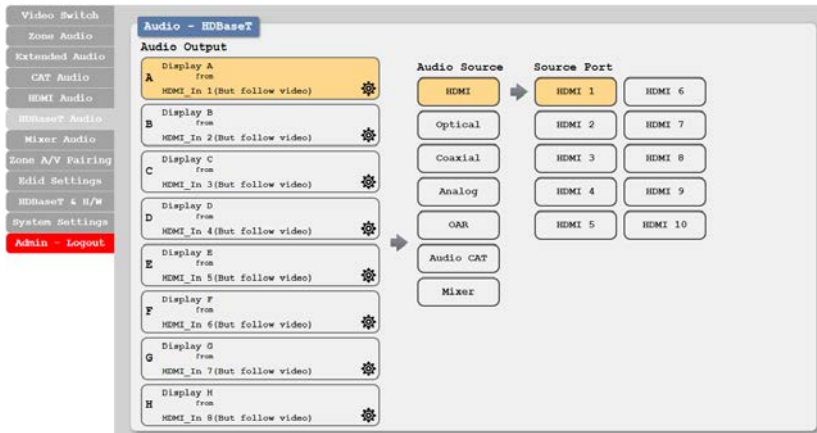

2) HDBaseT Audio Output Setting

Click the “Edit” icon (⚙️) to change the following settings:

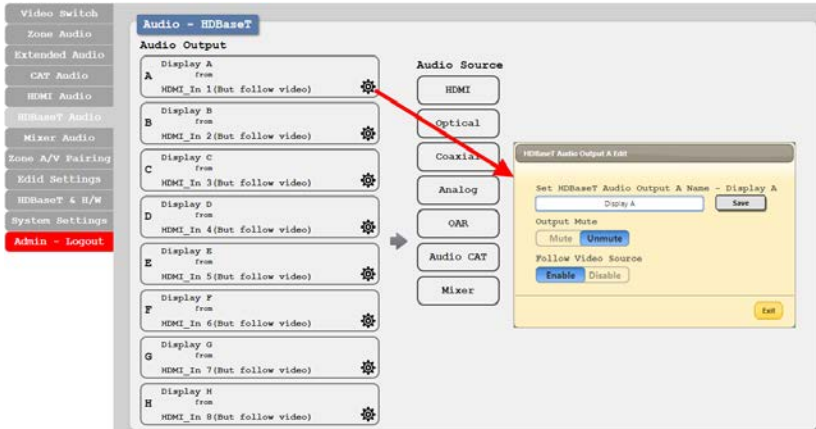

- **Output Name:** The HDBaseT Audio outputs can be renamed here.
- **Output Mute:** Mute may be turned on or off.
- **Follow Video Source:** Clicking the selection bar switches between “Enable” (follow video) or “Disable” (don’t follow video).

6.7.7 Mixer Audio Tab

The Audio Mixer feature allows for any two LPCM 2.0 audio sources to be mixed together. The matrix has three mixers in total and their settings can be adjusted on this tab.

1) Output and Input Routing

Click the buttons from left to right to choose each mixer's A & B sources. Only 2 sources total may be selected for each mixer. Once a new source has been selected, the change will happen immediately. Audio source options include HDMI, Optical, Coaxial, Analog, OAR and Audio CAT.

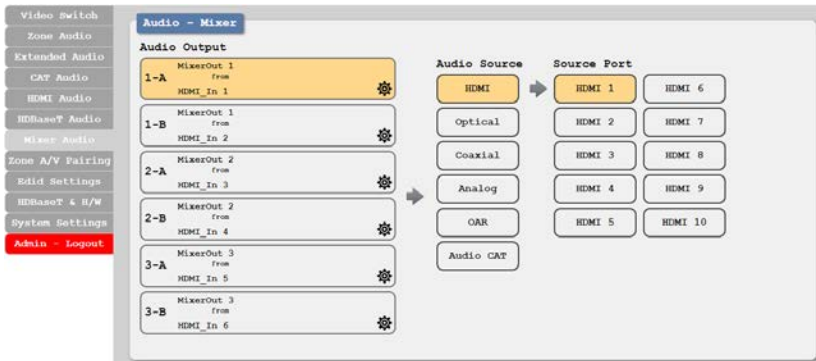

2) Mixed Audio Output Setting

Click the “Edit” icon (⚙️) to change the following settings:

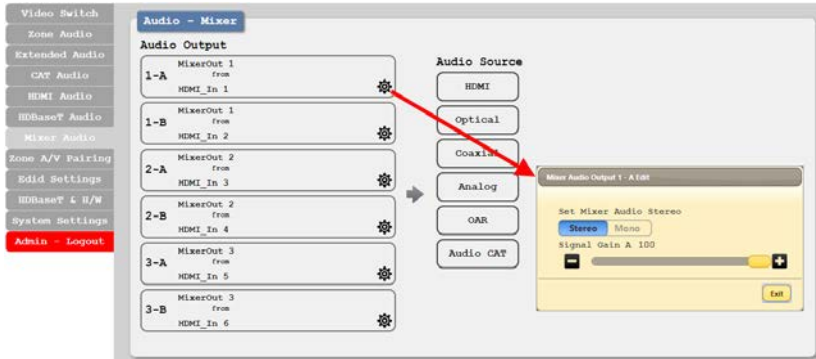

- **Set Mixer Audio Stereo:** Clicking the selection bar switches between “Stereo” and “Mono”.
- **Signal Gain:** The signal gain for each channel can be set from 0% to 100%.

6.7.8 Zone A/V Pairing Tab

The Zone A/V Pairing function allows the end user to control the matrix, using the supplied remote control, in a customized manner while in remote rooms (zones) containing an HDBaseT receiver and IR extender.

Each zone can have a different set of video/audio sources assigned to the buttons on the remote control for easy switching. The video and audio routing selections for each of the eight HDBaseT outputs need to be set up via the WebGUI in advance.

After setting them all up, the end user just needs to press a number key on the remote control unit once to change the routing status in whichever zone they are currently occupying. The distinct zone pairings can also be activated from within the WebGUI or by using Telnet/RS-232 commands.

1) Video and Audio Pairing Edit

Please click the “Edit” icon (⚙️) in the output zone you wish to configure and then set the video and audio routing settings associated with each IR remote button when used within that zone. Once you have completed your selections press “Save”.

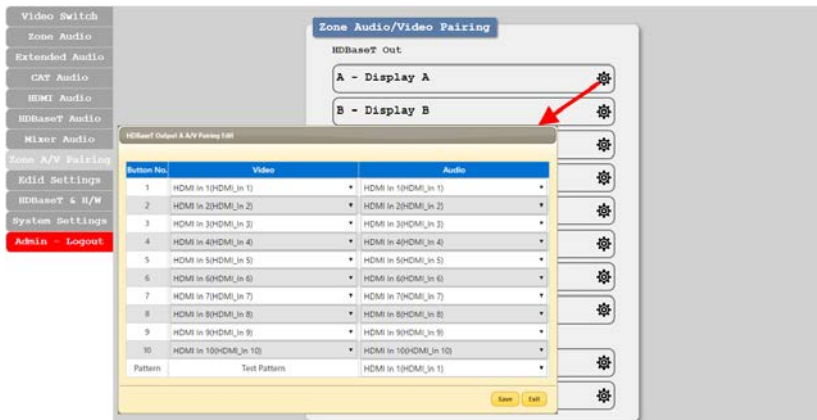

2) Quick Button Selection

To activate an audio/video pairing from the WebGUI, please select the preferred output zone to launch its selection window. The numbers 1-10 and "pattern" correspond to the keys on remote control unit and hovering the mouse over each button will reveal the routing currently associated with it.

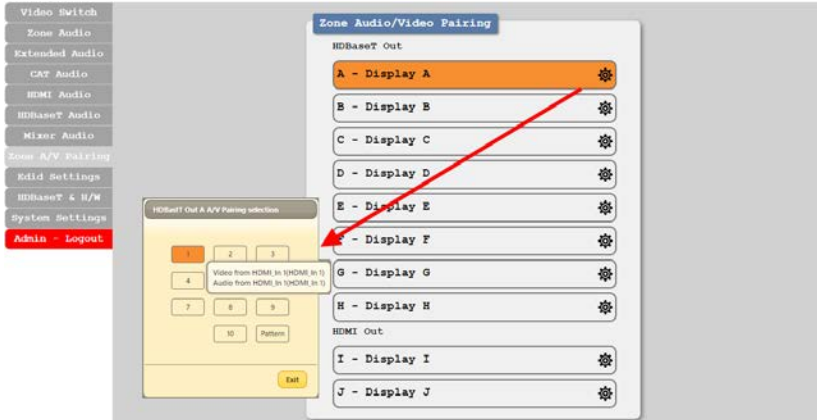

6.7.9 EDID Settings Tab

This matrix provides the option of six standard EDIDs, ten sink sourced EDIDs and four customer uploaded EDIDs that can be assigned to each input port individually. The names of the four customer uploaded EDIDs can be changed if desired.

1) Customer EDID Settings



- Edit Name:** Click the “Edit Name” button next to the custom EDID you wish to rename. Click the “Save” button to confirm the change.
- Download:** To save an existing custom EDID to your local PC, press the “Download” button next to the custom EDID you would like to save. An EDID Download sub-window will appear, allowing you to save the EDID file to your local PC. Select a save location and click the “Download” button in the sub-window, and the file will be transferred to your PC.
- Upload:** To upload a custom EDID, please click the “Upload” button next to the Customer EDID Settings item you would like to replace. An EDID Upload sub-window will appear, allowing you to select and upload your preferred EDID file from your local PC. Once the correct file has been selected, click the “Upload” button in the sub-window, and the file will be transferred to the matrix.

2) Sink EDID Download



- Download:** To save the EDID of a connected sink to your local PC, select the sink from the dropdown and then press the “Download” button. An EDID Download sub-window will appear, allowing you to save the EDID file to your local PC. Select a save location and click the “Download” button in the sub-window, and the file will be transferred to your PC.

3) Set EDID Input Content

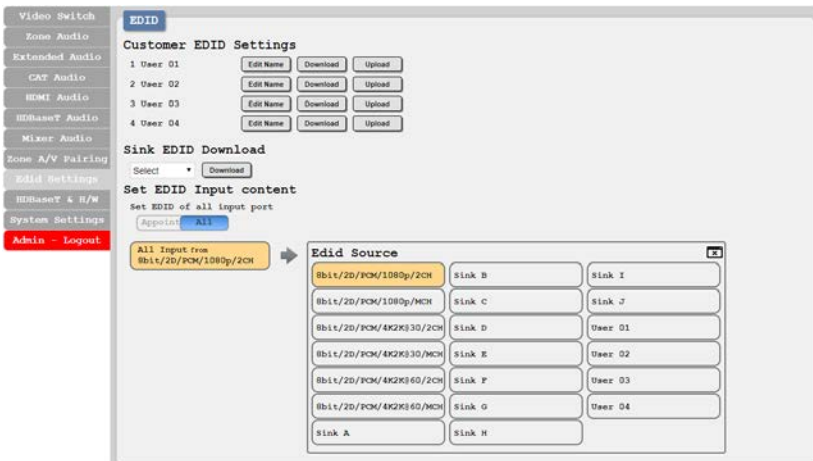

- Appoint/All:** The Set EDID Input Content section allows for the assignment of an EDID to each individual input port, or to all inputs at once. Click the selection bar to toggle between “Appoint” (individual assignment), or “All” inputs.



This unit provides the following 6 default EDIDs:

EDID Name	Video Content	Audio
FHD/2CH	1920×1080p@60Hz (148MHz), 8-bit color	LPCM 2.0
FHD/MCH	1920×1080p@60Hz (148MHz), 8-bit color	LPCM 7.1 & Bitstream
UHD/2CH	3840×2160p@30Hz (297MHz), Deep Color (8/10/12-bit)	LPCM 2.0
UHD/MCH	3840×2160p@30Hz (297MHz), Deep Color (8/10/12-bit)	LPCM 7.1 & Bitstream
UHD+/2CH	3840×2160p@60Hz (594MHz), Deep Color (8/10/12-bit)	LPCM 2.0
UHD+/MCH	3840×2160p@60Hz (594MHz), Deep Color (8/10/12-bit)	LPCM 7.1 & Bitstream

Note: In some rare cases it is possible for custom or external EDIDs to cause compatibility issues with certain sources. If this happens, it is recommended to switch to one of the 6 default EDIDs for maximum compatibility.

6.7.10 HDBaseT & H/W Info Tab

This tab provides information concerning the temperature inside the matrix (areas 1, 2 & 3) and the HDBaseT firmware versions used in the matrix and in connected receivers. Temperature area 1 is the left side of the output ports (from the front), area 2 is the right side of the output ports (from the front) and area 3 is at the middle of the HDMI inputs.

- Video Switch
- Zone Audio
- Extended Audio
- CAT Audio
- HDMI Audio
- HDBaseT Audio
- Mixer Audio
- Zone A/V Pairing
- Edd Settings
- HDBaseT & H/W
- System Settings
- Admin - Logout

HDBaseT & Hardware Information

Hardware monitor
 Area 1 : 37 °C
 Area 2 : 46 °C
 Area 3 : 43 °C

HDBaseT Information

Port	Local FWID	Remote FWID
A	V5100 Tx v3100.3	V5100 Rx v3136.1
B	V5100 Tx v3100.3	V5100 Rx v3136.1
C	V5100 Tx v3100.3	-
D	V5100 Tx v3100.3	-
E	V5100 Tx v3100.3	-
F	V5100 Tx v3100.3	-
G	V5100 Tx v3100.3	-
H	V5100 Tx v3100.3	-

6.7.11 System Settings Tab

This tab provides system configuration options including turning the power on/off, changing the network settings, downloading/restoring saved system configurations, resetting the system to factory defaults and updating the firmware.

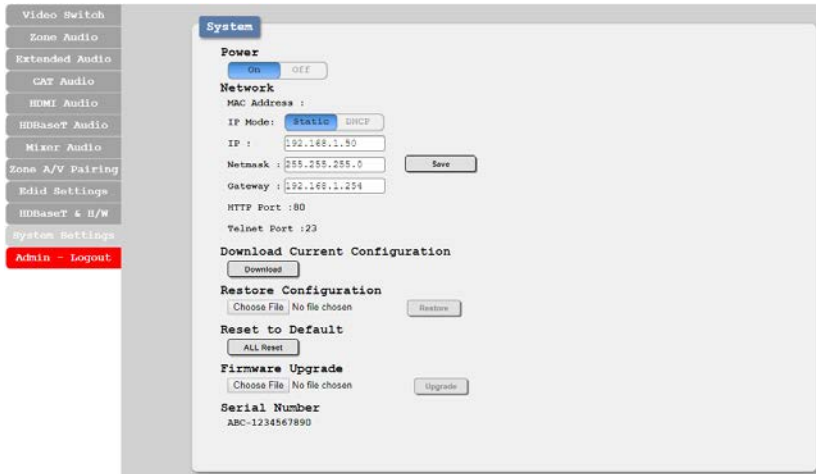

- **Power:** Press this switch to toggle the unit's power between ON and OFF (standby mode).

Note: While in standby mode the unit's WebGUI, Telnet and RS-232 controls are still active.
- **Network:** The unit's IP mode may be switched between Static IP or DHCP. In Static IP mode the IP, netmask and gateway addresses may be manually set. When in DHCP mode, the unit will attempt to connect to a local DHCP server and obtain IP, netmask and gateway addresses automatically. Please press "Save" after making any changes to the IP configuration or mode.

Note: Note: The unit's default IP address is 192.168.1.50. If the IP address is changed then the IP address required for WebGUI and Telnet access will also change accordingly.
- **Download Current Configuration:** Click the "Download" button to save the current system configuration to your local PC. The current system configuration will be saved as an XML file.
- **Restore Configuration:** To restore a previously saved system

configuration, click the “Choose File” button to locate the saved XML file, then click the “Restore” button.

- **Reset to Default:** Press the “ALL Reset” button to reset the unit to its factory default state. After the reset is complete, the unit will reboot automatically.
- **Firmware Upgrade:** To update the unit's firmware, click the “Choose File” button to open the file selection window and then select the firmware update file (*.bin format) located on your local PC. After selecting the file, click the “Upgrade” button to begin the firmware update process. The unit will automatically reboot to complete the update process.
- **Serial Number:** Displays the unit's serial number.

6.8 RS-232 Control

Serial Port Settings	
Baud Rate	115200
Data Bits	8
Parity Bit	None
Stop Bits	1
Flow Control	None

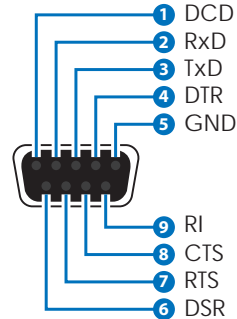

6.9 Telnet Control

Before attempting to use Telnet control, please ensure that both the unit and the PC are connected to the same active networks.

To Access the Command Line Interface (CLI)	
Windows 7	Click Start , type "cmd" in the search field, and press Enter .
Windows XP	Click Start > Run , type "cmd", and press Enter .
Mac OS X	Click Go > Applications > Utilities > Terminal .

Once in the Command Line Interface (CLI) type "**telnet**" followed by the IP address of the unit (and the port number if it is non-standard) and then hit "Enter". This will connect us to the unit we wish to control.

```
Microsoft Windows [Version 6.1.7601]
Copyright (c) 2009 Microsoft Corporation. All rights reserved.

C:\Users\Administrator>telnet 192.168.1.50 23
```

Note: The default IP address is 192.168.1.50. If the IP address is changed then the IP address required for Telnet access will also change accordingly.

6.10 RS-232 and Telnet Commands

6.10.1 Command Syntax

The RS-232/Telnet command structure for this unit is both flexible and powerful, and allows for multiple parameters to be set across multiple ports simultaneously within a single command transmission. This section will detail the command syntax used to send both simple (single port/single parameter) commands as well as the more complex (multi-port/parameter) commands.

The following multi-function syntax is specifically for use with these commands: "ZoneLineOut", "ExtLineOut", "AudioCAT_Out", "HDMI_Out", "HDBT_Out", "MixerOut", and "Pattern". "ZoneAvPair" has a special structure that will be explained separately. All other commands must be sent within discrete transmissions.

1) Basic Command Format

Use this syntax to set or change a single parameter for a single input/output port.

Command Format
<Command> {Port} {Parameter [= Value]}
Examples
ZoneLineOut B Treble= -12
HDBT_Out A Mute

2) Basic Command Format (ZoneAvPair)

The ZoneAvPair command requires multiple variables to define the location of the slot's value to adjust. This command only accepts 3 possible parameters: "VideoSrc", "AudioSrc", and "Load". Use the following syntax to set or change a single parameter for a single slot assigned to an HDBaseT or HDMI output port.

Command Format
ZoneAvPair HDBT_Out {Port} Slot {Slot} {Parameter [= Value]}
Examples
ZoneAvPair HDBT_Out B Slot 5 VideoSrc = HDMI_In 2
ZoneAvPair HDMI_Out J Slot 3 Load



3) Multi-Port Command Format

Use the following syntax to set or change a single parameter for multiple ports. Note that each additional port uses the “+” character for separation. The number of ports allowed in a single command is limited by the number of ports on that specific interface.

Command Format
<Command> {Port1}+{Port2}+{Etc.} {Parameter [= Value]}
Examples
ZoneLineOut A+B+C Treble = -12
HDBT_Out A+D+H Mute

4) Multi-Slot Command Format (ZoneAvPair)

The ZoneAvPair command allows for multiple slots on a single HDBaseT or HDMI output to be assigned the same value simultaneously. Use the following syntax to accomplish this. Note that each additional slot uses the “+” character for separation. The number of slots allowed in a single command is limited by the number of slots on that specific interface.

Command Format
ZoneAvPair HDBT_Out {Port} Slot {Slot1}+{Slot2}+{Etc.} {Param [= Value]}
Example
ZoneAvPair HDBT_Out B Slot 1+3+5 VideoSrc = HDMI_In 2

5) Multi-Parameter Command Format

Use the following syntax to set or change multiple parameters for a single port. Note that each additional parameter uses the “,” character for separation and spaces are allowed. The number of parameters allowed in a single command is limited only by the number of individual parameters that command has.

Command Format
<Command> {Port} {Param1 [= Value]}, {Param2 [= Value]}, {Etc.}
Examples
ZoneLineOut C Treble = -12, Mute, Delay = 100
HDBT_Out A VideoSrc = HDMI_In 1, AudioSrc = HDMI_In 1

6) Multi-Parameter Command Format (ZoneAvPair)

The “VideoSrc”, “AudioSrc” and “Load” parameters may be combined on a ZoneAvPair command. Note that the “,” character is used for separation.

Command Format
ZoneAvPair HDBT_Out {Port} Slot {Slot} {Param1=Value},{Param2=Value}
Example
ZoneAvPair HDBT_Out B Slot 5 VideoSrc=HDMI_In 2, AudioSrc=CoaxIn 1

7) Complex Multi-Port/Parameter Command Format

It is possible to have a single command that affects multiple ports with multiple groupings of parameters. All previously explained syntax rules must be observed and each additional set of ports/parameters are separated by the “&” character.

Command Format
<Command> {Port1}+{Port2}+{Etc.} {Param1 [= Value]}, {Param2 [= Value]}, {Etc.} & {Port1}+{Port2}+{Etc.} {Param1 [= Value]}, {Param2 [= Value]}, {Etc.} & Etc.
Example
HDBT_Out A+C+E VideoSrc=HDMI_In 2, AudioSrc=CoaxIn 2 & B+D Mute & F VideoSrc=HDMI_In 1, AudioSrc=HDMI_In 1



8) Complex Multi-Slot/Parameter Command Format (ZoneAvPair)

The ZoneAvPair command can also control multiple slots with multiple parameter groupings however the syntax is slightly different. Each command can only affect a single port at a time. Each additional set of slots/parameters are separated by the "&" character.

Command Format
ZoneAvPair HDBT_Out {Port} Slot {Slot1}+{Slot2}+{Etc.} {Param1=Value}, {Param2=Value} & Slot {Slot1}+{Slot2}+{Etc.} {Param1=Value}, {Param2=Value} & Etc.
Example
ZoneAvPair HDBT_Out B Slot 1 VideoSrc=HDMI_In 2, AudioSrc=CoaxIn 1 & Slot 2+3+4 VideoSrc=HDMI_In 2, AudioSrc=AnalogIn 1 & Slot 5+6 VideoSrc=HDMI_In 1, AudioSrc=HDMI_In 1 & Slot 1 Load

6.10.2 Real World Command Use

1) Zone A/V Pairing Mode Command Example

The easiest way to use the matrix for simple HDMI switching while still allowing for individually tailored zone audio is to use the Zone A/V Pairing setting within the WebGUI.

This is a configured and saved setting allowing each HDMI input to be paired with different audio inputs, depending on the zone it is being output to, for easy selection from a remote within that zone. For example, certain zones might not be able to handle surround sound, so you can pair the video in that zone with stereo inputs. Please refer to section 6.7.8 for details of Zone A/V Pairing configuration.

Command
Description
ZoneAvPair HDBT_Out A Slot 1 Load
Load the 1st A/V pairing for HDBaseT Output A's zone

2) Optical Audio Return (OAR) Command Example

If you are also using the Zone Audio outputs (Stereo Zones) for any zone we recommend using the Optical Audio Return (OAR) function to set the Zone Audio output to always play the audio coming from the TV itself. In this way the end user can freely switch between the matrix input on the TV and the internal tuner/smart functions of the TV and always be guaranteed audio (remember to set the TV's optical output to LPCM 2.0).

This command only needs to be resent after an audio only source has been selected for that individual Zone Audio output. Commonly a control system would have a "TV" button in the audio source selection area along with your other audio sources.

Command
Description
ZonelineOut A AudioSrc=OAR_In A
Zone Audio output "A" plays OAR audio from the TV connected to HDBaseT output "A"

3) HDMI Mirroring Command Example

If you have rack (head end) based AVR's for surround sound rooms we recommend using the HDMI outputs and the HDMI mirroring mode to easily have the audio and video sent to the AVR follow the signal sent to that zone's TV.

As long as no further commands are ever sent to the HDMI outputs of the matrix you only need to set this up once:

When using the mirroring function you can use any standard commands with the mirrored HDBaseT output and the mirroring HDMI output will follow the commands. These can be an A/V Pairing, Video or Audio commands, etc.

Command
Description
HDMI_Out I Mirroring=HDBT_Out A
Set HDMI output "I" to mirror HDBaseT output "A"



4) Audio Only source selection Command Examples

This unit offers 8 direct audio only inputs, while some of these inputs will likely be used for down mixed audio signals from surround sound sources (for stereo only zones) we expect audio only sources to be connected to deliver just audio to both TV zones and Audio Only zones.

Command
Description
ZonelineOut A AudioSrc=AnalogIn 1
Route Analog input 1 to Zone Audio output "A"
ZonelineOut A AudioSrc=OpticIn 1
Route Optical input 1 to Zone Audio output "A"
ZonelineOut A AudioSrc=CoaxIn 1
Route Coaxial input 1 to Zone Audio output "A"
ExtLineOut 1 AudioSrc=AnalogIn 1
Route Analog input 1 to Extended Line output "1"
ExtLineOut 1 AudioSrc=OpticIn 1
Route Optical input 1 to Extended Line output "1"
ExtLineOut 1 AudioSrc=CoaxIn 1
Route Coaxial input 1 to Extended Line output "1"

Above are just a few example of the audio selections available. Please refer to the full command listing for all possible commands. Remember if you have configured any audio zones to play the OAR audio from the TV within a zone you must be able to select this again to return to "listening" to that TV.

5) Individual Audio and Video Routing Command Examples

To offer the greatest level of flexibility the matrix can be used to send individual commands for both video and audio, this allows the installer to completely tailor the matrix to suit any possible configuration the end user may require.

Route audio and video from HDMI input 1 to HDBaseT output A independently:

Command
Description
HDBT_Out A VideoSrc=HDMI_In 1
Video switch command
HDBT_Out A AudioSrc=HDMI_In 1
Audio switch command

6) Combined Audio and Video Routing Command Example

It is also possible to switch audio and video simultaneous by using an advanced command structure. In this case the individual parameters of the "HDBT_Out" command are separated by a comma. Please refer to section 6.10.1 for additional information on how commands can be combined.

Route audio and video from HDMI input 1 to HDBaseT output A simultaneously:

Command
Description
HDBT_Out A VideoSrc=HDMI_In 1, AudioSrc=HDMI_In 1
Video and Audio switch command

Every individual audio and video input has a bespoke command (including separate commands for the audio and video within a HDMI source).

6.10.3 Full Command List

General System Commands

Command
Description & Parameters
?
Display all available commands.
Help
Display all available commands.
? {Command}
Display basic instructions for the command.
Ver
Display the firmware version.
P0
Enter light stand-by mode. <i>Note: RS-232, Ethernet and PoH functionality remains active.</i>
P1
Turn the power on.
P2
Enter deep stand-by mode. <i>Note: Only RS-232 functionality is still active.</i>
P?
Report the current power status.
FactoryDefault
Reset all settings to their factory defaults.
MAC
Display the unit's MAC address.

ZoneLineOut Commands

Command														
Description & Parameters														
<p>ZoneLineOut M AudioSrc=XXX</p> <p>Set the audio source for a zone line output.</p> <p>M = A ~ H</p> <p>Available values for XXX:</p> <table style="width: 100%; border-collapse: collapse;"> <tr> <td>HDMI_In n</td> <td style="text-align: right;">[n = 1 ~ 10]</td> </tr> <tr> <td>Opticl n</td> <td style="text-align: right;">[n = 1 ~ 2]</td> </tr> <tr> <td>Coaxln n</td> <td style="text-align: right;">[n = 1 ~ 2]</td> </tr> <tr> <td>Analogln n</td> <td style="text-align: right;">[n = 1 ~ 4]</td> </tr> <tr> <td>OAR_In n</td> <td style="text-align: right;">[n = A ~ H]</td> </tr> <tr> <td>CAT_In n</td> <td style="text-align: right;">[n = 1 ~ 2]</td> </tr> <tr> <td>MixerOut n</td> <td style="text-align: right;">[n = 1 ~ 3]</td> </tr> </table>	HDMI_In n	[n = 1 ~ 10]	Opticl n	[n = 1 ~ 2]	Coaxln n	[n = 1 ~ 2]	Analogln n	[n = 1 ~ 4]	OAR_In n	[n = A ~ H]	CAT_In n	[n = 1 ~ 2]	MixerOut n	[n = 1 ~ 3]
HDMI_In n	[n = 1 ~ 10]													
Opticl n	[n = 1 ~ 2]													
Coaxln n	[n = 1 ~ 2]													
Analogln n	[n = 1 ~ 4]													
OAR_In n	[n = A ~ H]													
CAT_In n	[n = 1 ~ 2]													
MixerOut n	[n = 1 ~ 3]													
<p>ZoneLineOut M Treble=XXX</p> <p>Set the treble value for a zone line output.</p> <p>M = A ~ H</p> <p>XXX = -12 ~ 12 (units: dB)</p>														
<p>ZoneLineOut M Bass=XXX</p> <p>Set the bass value for a zone line output.</p> <p>M = A ~ H</p> <p>XXX = -12 ~ 12 (units: dB)</p>														
<p>ZoneLineOut M Volume=XXX</p> <p>Set the volume for a zone line output.</p> <p>M = A ~ H</p> <p>XXX = 12 ~ -100 (units: dB)</p>														
<p>ZoneLineOut M Volume=Fast XXX</p> <p>Adjust the volume of a zone line output in large steps (2dB steps).</p> <p>M = A ~ H</p> <p>Available values for XXX:</p> <p>Up</p> <p>Down</p>														

ZoneLineOut Commands

Command
Description & Parameters
<p>ZoneLineOut M Volume=Slow XXX</p> <p>Adjust the volume of a zone line output in small steps (0.5dB steps).</p> <p>M = A ~ H</p> <p>Available values for XXX:</p> <p>Up Down</p>
<p>ZoneLineOut M Delay=XXX</p> <p>Set the audio delay for a zone line output.</p> <p>M = A ~ H</p> <p>XXX = 0 ~ 230 (units: ms)</p>
<p>ZoneLineOut M Mute</p> <p>Mute a zone line output.</p> <p>M = A ~ H</p>
<p>ZoneLineOut M Unmute</p> <p>Unmute a zone line output.</p> <p>M = A ~ H</p>
<p>ZoneLineOut M Status</p> <p>Display the status of a zone line output.</p> <p>M = A ~ H</p>
<p>ZoneLineOut M Name={NameString}</p> <p>Set the verbose name of a zone line output. Maximum 32 characters.</p> <p>M = A ~ H</p> <p><i>Note: Multi-port selection is not supported.</i></p>

ExtLineOut Commands

Command														
Description & Parameters														
<p>ExtLineOut M AudioSrc=XXX</p> <p>Set the audio source for an extended line output.</p> <p>M = 1 ~ 4</p> <p>Available values for XXX:</p> <table style="width: 100%; border-collapse: collapse;"> <tr> <td>HDMI_In n</td> <td style="text-align: right;">[n = 1 ~ 10]</td> </tr> <tr> <td>OpticIn n</td> <td style="text-align: right;">[n = 1 ~ 2]</td> </tr> <tr> <td>CoaxIn n</td> <td style="text-align: right;">[n = 1 ~ 2]</td> </tr> <tr> <td>AnalogIn n</td> <td style="text-align: right;">[n = 1 ~ 4]</td> </tr> <tr> <td>OAR_In n</td> <td style="text-align: right;">[n = A ~ H]</td> </tr> <tr> <td>CAT_In n</td> <td style="text-align: right;">[n = 1 ~ 2]</td> </tr> <tr> <td>MixerOut n</td> <td style="text-align: right;">[n = 1 ~ 3]</td> </tr> </table>	HDMI_In n	[n = 1 ~ 10]	OpticIn n	[n = 1 ~ 2]	CoaxIn n	[n = 1 ~ 2]	AnalogIn n	[n = 1 ~ 4]	OAR_In n	[n = A ~ H]	CAT_In n	[n = 1 ~ 2]	MixerOut n	[n = 1 ~ 3]
HDMI_In n	[n = 1 ~ 10]													
OpticIn n	[n = 1 ~ 2]													
CoaxIn n	[n = 1 ~ 2]													
AnalogIn n	[n = 1 ~ 4]													
OAR_In n	[n = A ~ H]													
CAT_In n	[n = 1 ~ 2]													
MixerOut n	[n = 1 ~ 3]													
<p>ExtLineOut M Treble=XXX</p> <p>Set the treble value for an extended line output.</p> <p>M = 1 ~ 4</p> <p>XXX = -12 ~ 12 (units: dB)</p>														
<p>ExtLineOut M Bass=XXX</p> <p>Set the bass value for an extended line output.</p> <p>M = 1 ~ 4</p> <p>XXX = -12 ~ 12 (units: dB)</p>														
<p>ExtLineOut M Volume=XXX</p> <p>Set the volume for an extended line output.</p> <p>M = 1 ~ 4</p> <p>XXX = 12 ~ -100 (units: dB)</p>														
<p>ExtLineOut M Volume=Fast XXX</p> <p>Adjust the volume of an extended line output in large steps (2dB steps).</p> <p>M = 1 ~ 4</p> <p>Available values for XXX:</p> <p>Up</p> <p>Down</p>														

ExtLineOut Commands

Command
Description & Parameters
ExtLineOut M Volume=Slow XXX
<p>Adjust the volume of an extended line output in small steps (0.5dB steps).</p> <p>M = 1 ~ 4.</p> <p>Available values for XXX:</p> <p>Up</p> <p>Down</p>
ExtLineOut M Delay=XXX
<p>Set the audio delay for an extended line output.</p> <p>M = 1 ~ 4</p> <p>XXX = 0 ~ 230 (units: ms)</p>
ExtLineOut M Mute
<p>Mute an extended line output.</p> <p>M = 1 ~ 4</p>
ExtLineOut M Unmute
<p>Unmute an extended line output.</p> <p>M = 1 ~ 4</p>
ExtLineOut M Status
<p>Display the status of an extended line output.</p> <p>M = 1 ~ 4</p>
ExtLineOut M Name={NameString}
<p>Set the verbose name of an extended line output. Maximum 32 characters.</p> <p>M = 1 ~ 4</p> <p><i>Note: Multi-port selection is not supported.</i></p>

OpticalIn Commands

Command
Description & Parameters
OpticalIn M Mute
Mute the specified optical audio input. M = 1 ~ 2
OpticalIn M unMute
Unmute the specified optical audio input. M = 1 ~ 2
OpticalIn M status
Show the current status of the specified optical audio input. M = 1 ~ 2

CoaxialIn Commands

Command
Description & Parameters
CoaxialIn M Mute
Mute the specified coaxial audio input. M = 1 ~ 2
CoaxialIn M unMute
Unmute the specified coaxial audio input. M = 1 ~ 2
CoaxialIn M status
Show the current status of the specified coaxial audio input. M = 1 ~ 2

AnalogIn Commands

Command
Description & Parameters
AnalogIn M Mute
Mute the specified analog audio input. M = 1 ~ 4
AnalogIn M unMute
Unmute the specified analog audio input. M = 1 ~ 4
AnalogIn M status
Show the current status of the specified analog audio input. M = 1 ~ 4

OARIn Commands

Command
Description & Parameters
OAR_In n M Mute
Mute the specified HDBaseT OAR audio source. M = A ~ H
OAR_In M unMute
Unmute the specified HDBaseT OAR audio source. M = A ~ H
OAR_In M status
Show the current status of the specified HDBaseT OAR audio source. M = A ~ H

CAT_In Commands

Command
Description & Parameters
CAT_In M Mute
Mute the specified Audio CAT audio input. M = 1 ~ 2
CAT_In M unMute
Unmute the specified Audio CAT audio input. M = 1 ~ 2
CAT_In M status
Show the current status of the specified Audio CAT audio input. M = 1 ~ 2

AudioCAT_Out Commands

Command														
Description & Parameters														
<p>AudioCAT_Out M AudioSrc=XXX</p> <p>Set the audio source for an AudioCAT output.</p> <p>M = 1 ~ 2</p> <p>Available values for XXX:</p> <table style="width: 100%; border-collapse: collapse;"> <tr> <td>HDMI_In n</td> <td style="text-align: right;">[n = 1 ~ 10]</td> </tr> <tr> <td>OpticIn n</td> <td style="text-align: right;">[n = 1 ~ 2]</td> </tr> <tr> <td>CoaxIn n</td> <td style="text-align: right;">[n = 1 ~ 2]</td> </tr> <tr> <td>AnalogIn n</td> <td style="text-align: right;">[n = 1 ~ 4]</td> </tr> <tr> <td>OAR_In n</td> <td style="text-align: right;">[n = A ~ H]</td> </tr> <tr> <td>CAT_In n</td> <td style="text-align: right;">[n = 1 ~ 2]</td> </tr> <tr> <td>MixerOut n</td> <td style="text-align: right;">[n = 1 ~ 3]</td> </tr> </table>	HDMI_In n	[n = 1 ~ 10]	OpticIn n	[n = 1 ~ 2]	CoaxIn n	[n = 1 ~ 2]	AnalogIn n	[n = 1 ~ 4]	OAR_In n	[n = A ~ H]	CAT_In n	[n = 1 ~ 2]	MixerOut n	[n = 1 ~ 3]
HDMI_In n	[n = 1 ~ 10]													
OpticIn n	[n = 1 ~ 2]													
CoaxIn n	[n = 1 ~ 2]													
AnalogIn n	[n = 1 ~ 4]													
OAR_In n	[n = A ~ H]													
CAT_In n	[n = 1 ~ 2]													
MixerOut n	[n = 1 ~ 3]													
<p>AudioCAT_Out M Status</p> <p>Display the status of an AudioCAT port.</p> <p>M = 1 ~ 2</p>														
<p>AudioCAT_Out M Name={NameString}</p> <p>Set the verbose name of an AudioCAT port. Maximum 32 characters.</p> <p>M = 1 ~ 2</p> <p><i>Note: Multi-port selection is not supported.</i></p>														

HDBT_Out Commands

Command																
Description & Parameters																
<p>HDBT_Out M AudioSrc=XXX</p> <p>Set the audio source for an HDBaseT output.</p> <p>M = A ~ H</p> <p>Available values for XXX:</p> <table style="width: 100%; border-collapse: collapse;"> <tr> <td>HDMI_In n</td> <td style="text-align: right;">[n = 1 ~ 10]</td> </tr> <tr> <td>OpticIn n</td> <td style="text-align: right;">[n = 1 ~ 2]</td> </tr> <tr> <td>CoaxIn n</td> <td style="text-align: right;">[n = 1 ~ 2]</td> </tr> <tr> <td>AnalogIn n</td> <td style="text-align: right;">[n = 1 ~ 4]</td> </tr> <tr> <td>OAR_In n</td> <td style="text-align: right;">[n = A ~ H]</td> </tr> <tr> <td>CAT_In n</td> <td style="text-align: right;">[n = 1 ~ 2]</td> </tr> <tr> <td>MixerOut n</td> <td style="text-align: right;">[n = 1 ~ 3]</td> </tr> <tr> <td>FollowVideo</td> <td></td> </tr> </table>	HDMI_In n	[n = 1 ~ 10]	OpticIn n	[n = 1 ~ 2]	CoaxIn n	[n = 1 ~ 2]	AnalogIn n	[n = 1 ~ 4]	OAR_In n	[n = A ~ H]	CAT_In n	[n = 1 ~ 2]	MixerOut n	[n = 1 ~ 3]	FollowVideo	
HDMI_In n	[n = 1 ~ 10]															
OpticIn n	[n = 1 ~ 2]															
CoaxIn n	[n = 1 ~ 2]															
AnalogIn n	[n = 1 ~ 4]															
OAR_In n	[n = A ~ H]															
CAT_In n	[n = 1 ~ 2]															
MixerOut n	[n = 1 ~ 3]															
FollowVideo																
<p>HDBT_Out M Mute</p> <p>Mute an HDBaseT output's audio.</p> <p>M = A ~ H</p>																
<p>HDBT_Out M Unmute</p> <p>Unmute an HDBaseT output's audio.</p> <p>M = A ~ H</p>																
<p>HDBT_Out M VideoSrc=XXX</p> <p>Set the video source for an HDBaseT output.</p> <p>M = A ~ H</p> <p>Available values for XXX:</p> <table style="width: 100%; border-collapse: collapse;"> <tr> <td>HDMI_In n</td> <td style="text-align: right;">[n = 1 ~ 10]</td> </tr> </table>	HDMI_In n	[n = 1 ~ 10]														
HDMI_In n	[n = 1 ~ 10]															
<p>HDBT_Out M VideoSrc=Pattern</p> <p>Set the video source of an HDBaseT output to the internal test pattern.</p> <p>M = A ~ H</p>																

HDBT_Out Commands

Command									
Description & Parameters									
<p>HDBT_Out M VideoSrc=Default</p> <p>Reset the video source of an HDBaseT Tx output to the factory default.</p> <p>M = A ~ H</p>									
<p>HDBT_Out M Status</p> <p>Display the status & properties of an HDBaseT output including audio/video matrix.</p> <p>M = A ~ H</p>									
<p>HDBT_Out M Name={NameString}</p> <p>Set the verbose name of an HDBaseT output. Maximum 32 characters.</p> <p>M = A ~ H</p> <p><i>Note: Multi-port selection is not supported.</i></p>									
<p>HDBT_Out M OSDString={OSDString}</p> <p>Set the OSD banner text for the specified HDBaseT output.</p> <p>M = A ~ H</p> <p><i>Note: Multi-port selection is not supported.</i></p>									
<p>HDBT_Out M OSDArea=XXX</p> <p>Set the OSD banner position for the specified HDBaseT output.</p> <p>M = A ~ H</p> <p>Available values for XXX:</p> <table style="width: 100%; border: none;"> <tr> <td style="padding: 2px 10px;">TopLeft</td> <td style="padding: 2px 10px;">TopCenter</td> <td style="padding: 2px 10px;">TopRight</td> </tr> <tr> <td style="padding: 2px 10px;">MiddleLeft</td> <td style="padding: 2px 10px;">MiddleCenter</td> <td style="padding: 2px 10px;">MiddleRight</td> </tr> <tr> <td style="padding: 2px 10px;">BottomLeft</td> <td style="padding: 2px 10px;">BottomCenter</td> <td style="padding: 2px 10px;">BottomRight</td> </tr> </table> <p><i>Note: Multi-port selection is not supported.</i></p>	TopLeft	TopCenter	TopRight	MiddleLeft	MiddleCenter	MiddleRight	BottomLeft	BottomCenter	BottomRight
TopLeft	TopCenter	TopRight							
MiddleLeft	MiddleCenter	MiddleRight							
BottomLeft	BottomCenter	BottomRight							

HDBT_Out Commands

Command
<p>Description & Parameters</p>
<p>HDBT_Out M OSDTimeout=Second</p> <p>Set the OSD banner display time for the specified HDBaseT output.</p> <p>M = A ~ H</p> <p>Available values for XXX:</p> <p>XXX = 0 ~ 60 (units: seconds, 0 = OSD is always on)</p> <p><i>Note: Multi-port selection is not supported.</i></p>
<p>HDBT_Out M OSDRow1=XXX</p> <p>Enable or disable row 1 of the OSD banner for the specified HDBaseT output.</p> <p>M = A ~ H</p> <p>Available values for XXX:</p> <p>On</p> <p>Off</p> <p><i>Note: Multi-port selection is not supported.</i></p>
<p>HDBT_Out M OSDRow2=XXX</p> <p>Enable or disable row 2 of the OSD banner for the specified HDBaseT output.</p> <p>M = A ~ H</p> <p>Available values for XXX:</p> <p>On</p> <p>Off</p> <p><i>Note: Multi-port selection is not supported.</i></p>

HDBT_Out Commands

Command
Description & Parameters
<p>HDBT_Out M OSDRow3=XXX</p> <p>Enable or disable row 3 of the OSD banner for the specified HDBaseT output.</p> <p>M = A ~ H</p> <p>Available values for XXX:</p> <p>On Off</p> <p><i>Note: Multi-port selection is not supported.</i></p>
<p>HDBT_Out M POE=XXX</p> <p>Enable or disable Power over HDBaseT support for the specified HDBaseT output.</p> <p>M = A ~ H</p> <p>Available values for XXX:</p> <p>On Off</p> <p><i>Note: Multi-port selection is not supported.</i></p>
<p>HDBT_Out M AVLC=XXX</p> <p>Set the AVLC compression quality for the specified HDBaseT output.</p> <p>M = A ~ H</p> <p>Available values for XXX:</p> <p>STD HQ</p> <p><i>Note: Multi-port selection is not supported.</i></p>
<p>HDBT_Out M CECSend={CEC hex code}</p> <p>Transmit the specified CEC command over the specified HDBaseT output.</p> <p>M = A ~ H</p>

HDBT_Out Commands

Command			
Description & Parameters			
HDBT_Out M PatternType=XXX			
Set the style to use for the test pattern on the specified HDBaseT output.			
M = A ~ H			
Available values for XXX :			
Red	Green	Blue	Black
White	Magenta	Yellow	Cyan
RampA	RampB	Toggle	ColorBar80
ColorBar90	ColorBar180	ColorBar360	
HDBT_Out M PatternTiming=XXX			
Set the output resolution for the test pattern used on the specified HDBaseT output.			
M = A ~ H			
Available values for XXX :			
480i	480p	576i	576p
720p50	720p60	1080p24	1080p25
1080p30	720p25	720p30	1080p50
1080p60	720p100	720p120	1080p100
1080p120	2160p24	2160p25	2160p30
2160p50	2160p60	2160p24DCI	2160p25DCI
2160p30DCI			

HDMI_In Commands

Command
Description & Parameters
HDMI_In M Status
<p>Display the status of an HDMI input.</p> <p>M = 1 ~ 10</p>
HDMI_In M Name={NameString}
<p>Set the verbose name of an HDMI input. Maximum 32 characters.</p> <p>M = 1 ~ 10</p> <p><i>Note: Multi-port selection is not supported.</i></p>
HDMI_In M CECSend={CEC hex code}
<p>Transmit the specified CEC command over the specified HDMI input.</p> <p>M = 1 ~ 10</p>
HDMI_In M HDCP=XXX
<p>Enable or disable HDCP support on the specified HDMI input.</p> <p>M = 1 ~ 10</p> <p>Available values for XXX:</p> <p>On</p> <p>Off</p>

HDMI_Out Commands

Command									
<p>Description & Parameters</p>									
<p>HDMI_Out M OSDString={OSDString}</p> <p>Set the OSD banner text for the specified HDMI output.</p> <p>M = I ~ J</p> <p><i>Note: Multi-port selection is not supported.</i></p>									
<p>HDMI_Out M OSDArea=XXX</p> <p>Set the OSD banner position for the specified HDMI output.</p> <p>M = I ~ J</p> <p>Available values for XXX:</p> <table border="0"> <tr> <td>TopLeft</td> <td>TopCenter</td> <td>TopRight</td> </tr> <tr> <td>MiddleLeft</td> <td>MiddleCenter</td> <td>MiddleRight</td> </tr> <tr> <td>BottomLeft</td> <td>BottomCenter</td> <td>BottomRight</td> </tr> </table> <p><i>Note: Multi-port selection is not supported.</i></p>	TopLeft	TopCenter	TopRight	MiddleLeft	MiddleCenter	MiddleRight	BottomLeft	BottomCenter	BottomRight
TopLeft	TopCenter	TopRight							
MiddleLeft	MiddleCenter	MiddleRight							
BottomLeft	BottomCenter	BottomRight							
<p>HDMI_Out M OSDTimeout=XXX</p> <p>Set the OSD banner display time for the specified HDMI output.</p> <p>M = I ~ J</p> <p>Available values for XXX:</p> <p>XXX = 0 ~ 60 (units: seconds, 0 = OSD is always on)</p> <p><i>Note: Multi-port selection is not supported.</i></p>									
<p>HDMI_Out M OSDRow1=XXX</p> <p>Enable or disable row 1 of the OSD banner for the specified HDMI output.</p> <p>M = I ~ J</p> <p>Available values for XXX:</p> <p>On</p> <p>Off</p> <p><i>Note: Multi-port selection is not supported.</i></p>									

HDMI_Out Commands

Command																
<p>Description & Parameters</p>																
<p>HDMI_Out M OSDRow2=XXX</p> <p>Enable or disable row 2 of the OSD banner for the specified HDMI output.</p> <p>M = I ~ J</p> <p>Available values for XXX:</p> <p>On Off</p> <p><i>Note: Multi-port selection is not supported.</i></p>																
<p>HDMI_Out M OSDRow3=XXX</p> <p>Enable or disable row 3 of the OSD banner for the specified HDMI output.</p> <p>M = I ~ J</p> <p>Available values for XXX:</p> <p>On Off</p> <p><i>Note: Multi-port selection is not supported.</i></p>																
<p>HDMI_Out M AudioSrc=XXX</p> <p>Set the audio source for an HDMI output.</p> <p>M = I ~ J</p> <p>Available values for XXX:</p> <table> <tbody> <tr> <td>HDMI_In n</td> <td>[n = 1 ~ 10]</td> </tr> <tr> <td>OpticIn n</td> <td>[n = 1 ~ 2]</td> </tr> <tr> <td>CoaxIn n</td> <td>[n = 1 ~ 2]</td> </tr> <tr> <td>AnalogIn n</td> <td>[n = 1 ~ 4]</td> </tr> <tr> <td>OAR_In n</td> <td>[n = A ~ H]</td> </tr> <tr> <td>CAT_In n</td> <td>[n = 1 ~ 2]</td> </tr> <tr> <td>MixerOut n</td> <td>[n = 1 ~ 3]</td> </tr> <tr> <td>FollowVideo</td> <td></td> </tr> </tbody> </table>	HDMI_In n	[n = 1 ~ 10]	OpticIn n	[n = 1 ~ 2]	CoaxIn n	[n = 1 ~ 2]	AnalogIn n	[n = 1 ~ 4]	OAR_In n	[n = A ~ H]	CAT_In n	[n = 1 ~ 2]	MixerOut n	[n = 1 ~ 3]	FollowVideo	
HDMI_In n	[n = 1 ~ 10]															
OpticIn n	[n = 1 ~ 2]															
CoaxIn n	[n = 1 ~ 2]															
AnalogIn n	[n = 1 ~ 4]															
OAR_In n	[n = A ~ H]															
CAT_In n	[n = 1 ~ 2]															
MixerOut n	[n = 1 ~ 3]															
FollowVideo																
<p>HDMI_Out M Mute</p> <p>Mute an HDMI output's audio.</p> <p>M = I ~ J</p>																

HDMI_Out Commands

Command
Description & Parameters
HDMI_Out M Unmute
Unmute an HDMI output's audio. M = I ~ J
HDMI_Out M VideoSrc=XXX
Set the video source for an HDMI output. M = I ~ J Available values for XXX : HDMI_In n [n = 1 ~ 10]
HDMI_Out M VideoSrc=Pattern
Set the video source of an HDMI output to the internal test pattern. M = I ~ J
HDMI_Out M VideoSrc=Default
Reset the video source of an HDMI output to the factory default. M = I ~ J
HDMI_Out M Mirroring=XXX
Set the audio/video mirroring source for an HDMI output. M = I ~ J Available values for XXX : HDBT_Out n [n = A ~ H]
HDMI_Out M Status
Display the status & properties of an HDMI output including audio/video matrix. M = I ~ J

HDMI_Out Commands

Command																												
Description & Parameters																												
<p>HDMI_Out M Name={NameString}</p> <p>Set the verbose name of an HDMI output. Maximum 32 characters.</p> <p>M = I ~ J</p> <p><i>Note: Multi-port selection is not supported.</i></p>																												
<p>HDMI_Out M PatternType=XXX</p> <p>Set the style to use for the test pattern on the specified HDMI output.</p> <p>M = I ~ J</p> <p>Available values for XXX:</p> <table style="width: 100%; border-collapse: collapse;"> <tr> <td style="width: 25%;">Red</td> <td style="width: 25%;">Green</td> <td style="width: 25%;">Blue</td> <td style="width: 25%;">Black</td> </tr> <tr> <td>White</td> <td>Magenta</td> <td>Yellow</td> <td>Cyan</td> </tr> <tr> <td>RampA</td> <td>RampB</td> <td>Toggle</td> <td>ColorBar80</td> </tr> <tr> <td>ColorBar90</td> <td>ColorBar180</td> <td>ColorBar360</td> <td></td> </tr> </table>	Red	Green	Blue	Black	White	Magenta	Yellow	Cyan	RampA	RampB	Toggle	ColorBar80	ColorBar90	ColorBar180	ColorBar360													
Red	Green	Blue	Black																									
White	Magenta	Yellow	Cyan																									
RampA	RampB	Toggle	ColorBar80																									
ColorBar90	ColorBar180	ColorBar360																										
<p>HDMI_Out M PatternTiming=XXX</p> <p>Set the output resolution for the test pattern used on the specified HDMI output.</p> <p>M = I ~ J</p> <p>Available values for XXX:</p> <table style="width: 100%; border-collapse: collapse;"> <tr> <td style="width: 25%;">480i</td> <td style="width: 25%;">480p</td> <td style="width: 25%;">576i</td> <td style="width: 25%;">576p</td> </tr> <tr> <td>720p50</td> <td>720p60</td> <td>1080p24</td> <td>1080p25</td> </tr> <tr> <td>1080p30</td> <td>720p25</td> <td>720p30</td> <td>1080p50</td> </tr> <tr> <td>1080p60</td> <td>720p100</td> <td>720p120</td> <td>1080p100</td> </tr> <tr> <td>1080p120</td> <td>2160p24</td> <td>2160p25</td> <td>2160p30</td> </tr> <tr> <td>2160p50</td> <td>2160p60</td> <td>2160p24DCI</td> <td>2160p25DCI</td> </tr> <tr> <td>2160p30DCI</td> <td></td> <td></td> <td></td> </tr> </table>	480i	480p	576i	576p	720p50	720p60	1080p24	1080p25	1080p30	720p25	720p30	1080p50	1080p60	720p100	720p120	1080p100	1080p120	2160p24	2160p25	2160p30	2160p50	2160p60	2160p24DCI	2160p25DCI	2160p30DCI			
480i	480p	576i	576p																									
720p50	720p60	1080p24	1080p25																									
1080p30	720p25	720p30	1080p50																									
1080p60	720p100	720p120	1080p100																									
1080p120	2160p24	2160p25	2160p30																									
2160p50	2160p60	2160p24DCI	2160p25DCI																									
2160p30DCI																												
<p>HDMI_Out M CECSend={CEC hex code}</p> <p>Transmit the specified CEC command over the specified HDMI output.</p> <p>M = I ~ J</p>																												

MixerOut Commands

Command												
<p>Description & Parameters</p>												
<p>MixerOut M AudioSrc N=XXX</p> <p>Set the audio source for an audio mixer input channel.</p> <p>M = 1 ~ 3</p> <p>N = A ~ B</p> <p>Available values for XXX:</p> <table> <tr> <td>HDMI_In n</td> <td>[n = 1 ~ 10]</td> </tr> <tr> <td>Opticl n</td> <td>[n = 1 ~ 2]</td> </tr> <tr> <td>Coaxln n</td> <td>[n = 1 ~ 2]</td> </tr> <tr> <td>Analogln n</td> <td>[n = 1 ~ 4]</td> </tr> <tr> <td>OAR_In n</td> <td>[n = A ~ H]</td> </tr> <tr> <td>CAT_In n</td> <td>[n = 1 ~ 2]</td> </tr> </table>	HDMI_In n	[n = 1 ~ 10]	Opticl n	[n = 1 ~ 2]	Coaxln n	[n = 1 ~ 2]	Analogln n	[n = 1 ~ 4]	OAR_In n	[n = A ~ H]	CAT_In n	[n = 1 ~ 2]
HDMI_In n	[n = 1 ~ 10]											
Opticl n	[n = 1 ~ 2]											
Coaxln n	[n = 1 ~ 2]											
Analogln n	[n = 1 ~ 4]											
OAR_In n	[n = A ~ H]											
CAT_In n	[n = 1 ~ 2]											
<p>MixerOut M Gain N=XXX</p> <p>Set the gain level of an audio mixer input channel.</p> <p>M = 1 ~ 3</p> <p>N = A ~ B</p> <p>XXX = 0 ~ 100 (units: percent)</p>												
<p>MixerOut M Mono</p> <p>Set the output of a mixer channel to "mono" mode. Left and right channel outputs will be the same.</p> <p>M = 1 ~ 3</p>												
<p>MixerOut M Stereo</p> <p>Set the output of a mixer channel to "stereo" mode.</p> <p>M = 1 ~ 3</p>												
<p>MixerOut M Status</p> <p>Display the status of a mixer channel.</p> <p>M = 1 ~ 3</p>												

Preset Commands

Command
Description & Parameters
<p>Preset Save M</p> <p>Save the current A/V routing as a preset.</p> <p>M = 1 ~ 8</p>
<p>Preset Load M</p> <p>Load and activate a saved A/V preset.</p> <p>M = 1 ~ 8</p>
<p>Preset Show [M]</p> <p>List the contents of a stored A/V preset.</p> <p>M = 1 ~ 8</p> <p><i>Note: If M is omitted, all A/V presets will be listed.</i></p>
<p>Preset Name M={NameString}</p> <p>Set the verbose name of a preset. Maximum 32 characters.</p> <p>M = 1 ~ 8</p>

EDID Commands

Command						
Description & Parameters						
<p>EDID All=XXX</p> <p>Set the EDID source for all HDMI input ports.</p> <p>Available values for XXX:</p> <table style="width: 100%; border: none;"> <tr> <td style="width: 50%;">1 ~ 6</td> <td>[Factory EDIDs]</td> </tr> <tr> <td>7 ~ 16</td> <td>[Sink EDIDs]</td> </tr> <tr> <td>17 ~ 20</td> <td>[User EDIDs]</td> </tr> </table>	1 ~ 6	[Factory EDIDs]	7 ~ 16	[Sink EDIDs]	17 ~ 20	[User EDIDs]
1 ~ 6	[Factory EDIDs]					
7 ~ 16	[Sink EDIDs]					
17 ~ 20	[User EDIDs]					
<p>EDID HDMI_In M=XXX</p> <p>Set the EDID source for a single HDMI port.</p> <p>M = 1 ~ 10</p> <p>Available values for XXX:</p> <table style="width: 100%; border: none;"> <tr> <td style="width: 50%;">1 ~ 6</td> <td>[Factory EDIDs]</td> </tr> <tr> <td>7 ~ 16</td> <td>[Sink EDIDs]</td> </tr> <tr> <td>17 ~ 20</td> <td>[User EDIDs]</td> </tr> </table>	1 ~ 6	[Factory EDIDs]	7 ~ 16	[Sink EDIDs]	17 ~ 20	[User EDIDs]
1 ~ 6	[Factory EDIDs]					
7 ~ 16	[Sink EDIDs]					
17 ~ 20	[User EDIDs]					
<p>EDID M Name={NameString}</p> <p>Set the verbose name of a user EDID slot. Maximum 16 characters.</p> <p>M = 17 ~ 20</p>						

ZoneAVPair Commands

Command														
Description & Parameters														
<p>ZoneAvPair HDBT_Out M Slot N AudioSrc=XXX</p> <p>Assign an audio source to a Zone A/V Pair slot on an HDBaseT output.</p> <p>M = A ~ H N = 1 ~ 10</p> <p>Available values for XXX:</p> <table style="width: 100%; border-collapse: collapse;"> <tr> <td>HDMI_In n</td> <td style="text-align: right;">[n = 1 ~ 10]</td> </tr> <tr> <td>OpticIn n</td> <td style="text-align: right;">[n = 1 ~ 2]</td> </tr> <tr> <td>CoaxIn n</td> <td style="text-align: right;">[n = 1 ~ 2]</td> </tr> <tr> <td>AnalogIn n</td> <td style="text-align: right;">[n = 1 ~ 4]</td> </tr> <tr> <td>OAR_In n</td> <td style="text-align: right;">[n = A ~ H]</td> </tr> <tr> <td>CAT_In n</td> <td style="text-align: right;">[n = 1 ~ 2]</td> </tr> <tr> <td>MixerOut n</td> <td style="text-align: right;">[n = 1 ~ 3]</td> </tr> </table>	HDMI_In n	[n = 1 ~ 10]	OpticIn n	[n = 1 ~ 2]	CoaxIn n	[n = 1 ~ 2]	AnalogIn n	[n = 1 ~ 4]	OAR_In n	[n = A ~ H]	CAT_In n	[n = 1 ~ 2]	MixerOut n	[n = 1 ~ 3]
HDMI_In n	[n = 1 ~ 10]													
OpticIn n	[n = 1 ~ 2]													
CoaxIn n	[n = 1 ~ 2]													
AnalogIn n	[n = 1 ~ 4]													
OAR_In n	[n = A ~ H]													
CAT_In n	[n = 1 ~ 2]													
MixerOut n	[n = 1 ~ 3]													
<p>ZoneAvPair HDBT_Out M Slot N VideoSrc=XXX</p> <p>Assign a video source to a Zone A/V Pair slot on an HDBaseT output.</p> <p>M = A ~ H N = 1 ~ 11</p> <p>Available values for XXX:</p> <table style="width: 100%; border-collapse: collapse;"> <tr> <td>HDMI_In n</td> <td style="text-align: right;">[n = 1 ~ 10]</td> </tr> <tr> <td>Pattern</td> <td></td> </tr> </table> <p><i>Note: HDMI_In is not available for use with slot 11.</i></p>	HDMI_In n	[n = 1 ~ 10]	Pattern											
HDMI_In n	[n = 1 ~ 10]													
Pattern														
<p>ZoneAvPair HDBT_Out M Slot N Load</p> <p>Load and activate the contents of a Zone A/V Pair slot on an HDBaseT output.</p> <p>M = A ~ H N = 1 ~ 11</p>														

ZoneAVPair Commands

Command														
Description & Parameters														
ZoneAvPair HDMI_Out M Slot N AudioSrc=XXX														
<p>Assign an audio source to a Zone A/V Pair slot on an HDMI output.</p> <p>M = I ~ J N = 1 ~ 11</p> <p>Available values for XXX:</p> <table style="width: 100%; border-collapse: collapse;"> <tr> <td>HDMI_In n</td> <td style="text-align: right;">[n = 1 ~ 10]</td> </tr> <tr> <td>Opticl n</td> <td style="text-align: right;">[n = 1 ~ 2]</td> </tr> <tr> <td>Coaxln n</td> <td style="text-align: right;">[n = 1 ~ 2]</td> </tr> <tr> <td>Analogln n</td> <td style="text-align: right;">[n = 1 ~ 4]</td> </tr> <tr> <td>OAR_In n</td> <td style="text-align: right;">[n = A ~ H]</td> </tr> <tr> <td>CAT_In n</td> <td style="text-align: right;">[n = 1 ~ 2]</td> </tr> <tr> <td>MixerOut n</td> <td style="text-align: right;">[n = 1 ~ 3]</td> </tr> </table>	HDMI_In n	[n = 1 ~ 10]	Opticl n	[n = 1 ~ 2]	Coaxln n	[n = 1 ~ 2]	Analogln n	[n = 1 ~ 4]	OAR_In n	[n = A ~ H]	CAT_In n	[n = 1 ~ 2]	MixerOut n	[n = 1 ~ 3]
HDMI_In n	[n = 1 ~ 10]													
Opticl n	[n = 1 ~ 2]													
Coaxln n	[n = 1 ~ 2]													
Analogln n	[n = 1 ~ 4]													
OAR_In n	[n = A ~ H]													
CAT_In n	[n = 1 ~ 2]													
MixerOut n	[n = 1 ~ 3]													
ZoneAvPair HDMI_Out M Slot N VideoSrc=XXX														
<p>Assign a video source to a Zone A/V Pair slot on an HDMI output.</p> <p>M = I ~ J N = 1 ~ 11</p> <p>Available values for XXX:</p> <table style="width: 100%; border-collapse: collapse;"> <tr> <td>HDMI_In n</td> <td style="text-align: right;">[n = 1 ~ 10]</td> </tr> <tr> <td>Pattern</td> <td></td> </tr> </table> <p><i>Note: HDMI_In is not available for use with slot 11.</i></p>	HDMI_In n	[n = 1 ~ 10]	Pattern											
HDMI_In n	[n = 1 ~ 10]													
Pattern														
ZoneAvPair HDMI_Out M Slot N Load														
<p>Load and activate the contents of a Zone A/V Pair slot on an HDMI output.</p> <p>M = I ~ J N = 1 ~ 11</p>														

IRGenerator Commands

Command
Description & Parameters
IRGenerator Code={IR hex code}
Transmit the specified IR code.

IR_Route Commands

Command								
Description & Parameters								
<p>IR_Route HDBT_Out M0 M1 M2</p> <p>Select the IR source(s) for an HDBaseT output. M0 is the output port index. M1 is the function to use. M2 is the IR input source.</p> <p>M0 = A ~ H</p> <p>Available values for M1:</p> <table style="width: 100%; border: none;"> <tr> <td style="padding: 2px 5px;">Add</td> <td style="padding: 2px 5px;">[Add M2 source to M0]</td> </tr> <tr> <td style="padding: 2px 5px;">Del</td> <td style="padding: 2px 5px;">[Delete M2 source from M0]</td> </tr> </table> <p>Available values for M2:</p> <table style="width: 100%; border: none;"> <tr> <td style="padding: 2px 5px;">IR_InAll</td> <td style="padding: 2px 5px;">[IR In (ALL) input jack]</td> </tr> <tr> <td style="padding: 2px 5px;">Generator</td> <td style="padding: 2px 5px;">[Internal IR encoder]</td> </tr> </table>	Add	[Add M2 source to M0]	Del	[Delete M2 source from M0]	IR_InAll	[IR In (ALL) input jack]	Generator	[Internal IR encoder]
Add	[Add M2 source to M0]							
Del	[Delete M2 source from M0]							
IR_InAll	[IR In (ALL) input jack]							
Generator	[Internal IR encoder]							
<p>IR_Route HDBT_Out M0 Show</p> <p>Display the current IR source of the HDBaseT output.</p> <p>M0 = A ~ H</p>								
<p>IR_Route IR_Out M0 M1 M2</p> <p>Select the IR source(s) for an IR Output jack (next to each HDMI input). M0 is the output port index. M1 is the function to use. M2 is the IR input source.</p> <p>M0 = 1 ~ 10</p> <p>Available values for M1:</p> <table style="width: 100%; border: none;"> <tr> <td style="padding: 2px 5px;">Add</td> <td style="padding: 2px 5px;">[Add M2 source to M0]</td> </tr> <tr> <td style="padding: 2px 5px;">Del</td> <td style="padding: 2px 5px;">[Delete M2 source from M0]</td> </tr> </table> <p>Available values for M2:</p> <table style="width: 100%; border: none;"> <tr> <td style="padding: 2px 5px;">IR_InAll</td> <td style="padding: 2px 5px;">[IR In (ALL) input jack]</td> </tr> <tr> <td style="padding: 2px 5px;">Generator</td> <td style="padding: 2px 5px;">[Internal IR encoder]</td> </tr> </table>	Add	[Add M2 source to M0]	Del	[Delete M2 source from M0]	IR_InAll	[IR In (ALL) input jack]	Generator	[Internal IR encoder]
Add	[Add M2 source to M0]							
Del	[Delete M2 source from M0]							
IR_InAll	[IR In (ALL) input jack]							
Generator	[Internal IR encoder]							
<p>IR_Route IR_Out M0 Show</p> <p>Display the current IR source for an IR Output jack (next to each HDMI input).</p> <p>M0 = 1 ~ 10</p>								

UART Commands

Command												
Description & Parameters												
<p>UART M BaudRate=XXX</p> <p>Set the RS-232 baud rate for the specified HDBaseT output.</p> <p>M = A ~ H</p> <p>Available values for XXX:</p> <table style="width: 100%; border: none;"> <tr> <td style="text-align: center;">2400</td> <td style="text-align: center;">4800</td> <td style="text-align: center;">7200</td> <td style="text-align: center;">9600</td> </tr> <tr> <td style="text-align: center;">14400</td> <td style="text-align: center;">19200</td> <td style="text-align: center;">38400</td> <td style="text-align: center;">57600</td> </tr> <tr> <td style="text-align: center;">115200</td> <td></td> <td></td> <td></td> </tr> </table>	2400	4800	7200	9600	14400	19200	38400	57600	115200			
2400	4800	7200	9600									
14400	19200	38400	57600									
115200												
<p>UART M DataBit=XXX</p> <p>Set the RS-232 data bits for the specified HDBaseT output.</p> <p>M = A ~ H</p> <p>XXX = 5 ~ 8</p>												
<p>UART M Parity=XXX</p> <p>Set the RS-232 parity for the specified HDBaseT output.</p> <p>M = A ~ H</p> <p>Available values for XXX:</p> <table style="width: 100%; border: none;"> <tr> <td style="text-align: center;">None</td> <td style="text-align: center;">Odd</td> <td style="text-align: center;">Even</td> </tr> </table>	None	Odd	Even									
None	Odd	Even										
<p>UART M UartSend={DataString}</p> <p>Transmit a data string to the RS-232 port on the specified HDBaseT output.</p> <p>M = A ~ H</p>												
<p>UART M Status</p> <p>Display the current RS-232 settings for the specified HDBaseT output.</p> <p>M = A ~ H</p>												

Note: Commands will not be executed unless followed by a carriage return. Commands are not case-sensitive.

7. CONNECTION DIAGRAM

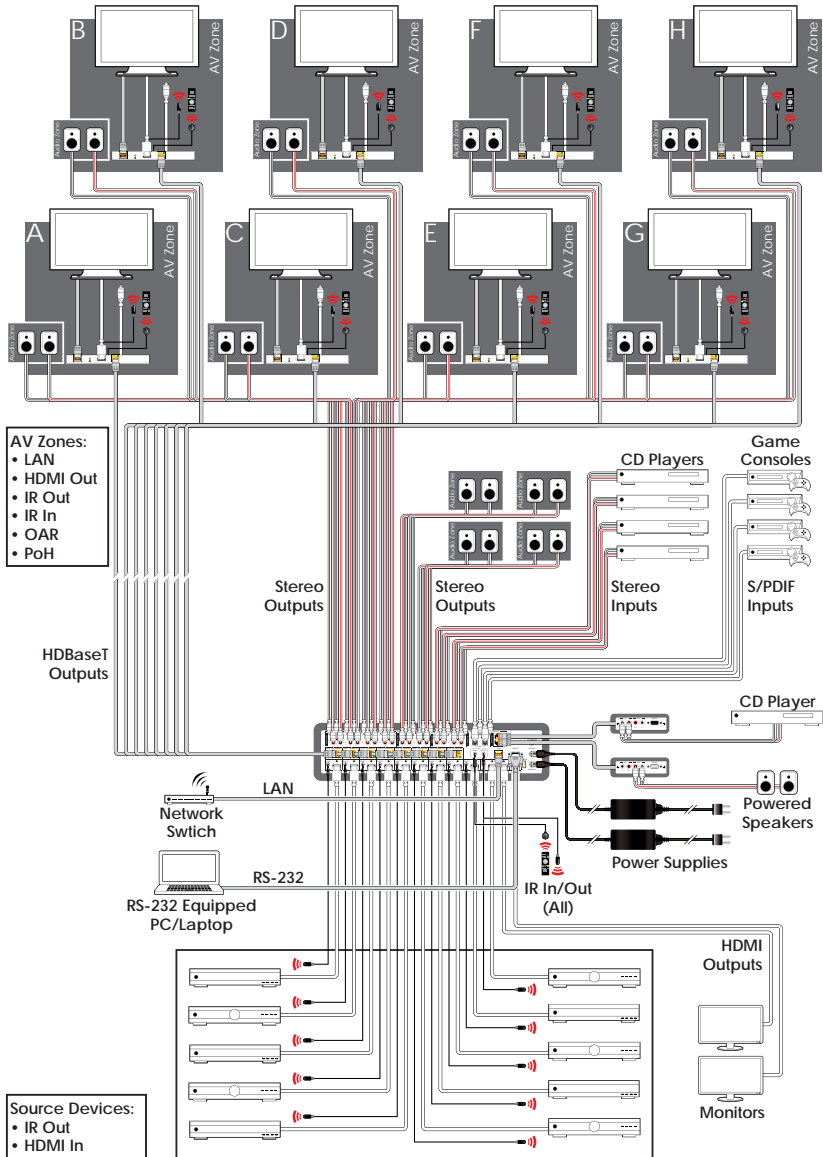

8. SPECIFICATIONS

8.1 Technical Specifications

HDMI Bandwidth	600MHz/18Gbps
HDBaseT Bandwidth	340MHz/10.2Gbps
Input Ports	10×HDMI 2×S/PDIF (TOSLINK) 2×S/PDIF (RCA) 4×Analog Stereo (8×RCA)
Output Ports	8×HDBaseT (RJ-45) 2×HDMI 12×Analog Stereo (24×RCA)
Bidirectional Ports	2×Audio CAT (RJ-45)
Pass-through/Control Ports	9×IR Extender (3.5mm) 11×IR Blaster (3.5mm) 1×RS-232 (DE-9) 1×LAN (RJ-45)
Service Port	1×USB (Type-A)
IR Frequency	30–50kHz (30–60kHz under ideal conditions)
Baud Rate	Up to 115200bps
Power Supply	24V/6.25A DC (US/EU standards, CE/FCC/UL certified)
ESD Protection	Human Body Model: ±8kV (Air Discharge) ±4kV (Contact Discharge)
Dimensions	438mm×88mm×316mm (W×H×D) [Case Only] 483mm×96mm×356mm (W×H×D) [All Inclusive]
Weight	6,500g



Chassis Material	Metal (Steel)
Silkscreen Color	Black
Operating Temperature	0 °C–40 °C/32 °F–104 °F
Storage Temperature	-20 °C–60 °C/-4 °F–140 °F
Relative Humidity	20–90% RH (Non-condensing)
Power Consumption	236W

8.2 Video Specifications

Supported Resolutions (Hz)	Input	Output	
	HDMI	HDMI	HDBaseT
480i@60	✓	✓	✓
480p@60	✓	✓	✓
576i@60	✓	✓	✓
576p@60	✓	✓	✓
640×480@60	✓	✓	✓
800×600@60	✓	✓	✓
720p@50/60	✓	✓	✓
1080i@50/60	✓	✓	✓
1080p@24/50/60	✓	✓	✓
1024×768@60	✓	✓	✓
1280×1024@60	✓	✓	✓
1360×768@60	✓	✓	✓
1600×1200@60	✓	✓	✓
1920×1200@60	✓	✓	✓
2560×1440@60	✓	✓	✓
3840×2160@24/25/30	✓	✓	✓
3840×2160@50/59.94/60 (4:2:0)	✓	✓	✓
3840×2160@50/59.94/60 (4:4:4)	✓	✓	AVLC

Supported Resolutions (Hz)	Input	Output	
	HDMI	HDMI	HDBaseT
4096×2160@24/25/30	✓	✓	✓
4096×2160@50/59.94/60 (4:2:0)	✓	✓	✓
4096×2160@50/59.94/60 (4:4:4)	✓	✓	x

8.3 Audio Specifications

8.3.1 Analog Audio

Analog (Stereo) Input	
Max Audio Level	2Vrms
Impedance	10kΩ
Type	Unbalanced

Analog (Stereo) Output	
Max Audio Level	2Vrms
THD+N	< -80dB@0dBFS 1kHz (A-wt)
SNR	> 100dB@0dBFS
Frequency Response	< ±0.5dB@20Hz~20kHz
Crosstalk	< -90dB@10kHz
Impedance	470Ω
Type	Unbalanced

8.3.2 Analog Audio Adjustments

- 1) **Output Volume:** -100dB to 0dB with 0.5dB per step (for both zone and extended audio).
- 2) **Treble/Bass:** From -12dB to +12dB with 1dB per step.
- 3) **Audio Delay:** Up to 230ms per channel, for line-out only, with 1ms per step.
- 4) **Audio Mixer:** Mixes any two audio sources into a single channel. Three mixers in total. Mixer gain is adjustable from 0%~100%.

Note: Audio break away functionality is only supported with LPCM



2.0 format audio. The OAR, optical, coaxial, and Audio CAT inputs only support LPCM 2.0 audio.

8.3.3 Digital Audio

HDMI Input/Output	
LPCM	
Max Channels	8 Channels
Sampling Rate (kHz)	32, 44.1, 48, 88.2, 96, 176.4, 192
Bitstream	
Supported Formats	Standard & High-Definition

Digital (S/PDIF) Input	
LPCM	
Max Channels	2 Channels
Sampling Rate (kHz)	32, 44.1, 48, 88.2, 96, 176.4, 192
Bitstream	
Supported Formats	None

Audio CAT	
LPCM	
Max Channels	2 Channels
Sampling Rate (kHz)	32, 44.1, 48, 88.2, 96, 176.4, 192
Bitstream	
Supported Formats	None

Optical Audio Return (OAR)	
LPCM	
Max Channels	2 Channels
Sampling Rate (kHz)	32, 44.1, 48, 88.2, 96
Bitstream	
Supported Formats	None

8.4 Cable Specifications

HDMI Cable Length	1080p		4K30	4K60
	8-bit	12-bit	8-bit	8-bit
High Speed HDMI Cable				
HDMI Input	10m		5m	3m
HDMI Output	10m		5m	3m
Ethernet Cable				
Cat.5e/6	100m		70m	
Cat.6a/7	100m		100m	

- **1080p (FHD Video)**
 - Up to 1080p@60Hz, 12-bit color
 - Data rates lower than 5.3Gbps or below 225MHz TMDS clock
- **4K30 (UHD Video)**
 - 4K@24/25/30Hz & 4K@50/60Hz (4:2:0), 8-bit color
 - 4K@50/60Hz (4:4:4, 8-bit) with AVLC active
 - Data rates higher than 5.3Gbps or above 225MHz TMDS clock but below 10.2Gbps
- **4K60 (UHD+ Video)**
 - 4K@50/60Hz (4:4:4, 8-bit), AVLC required over HDBaseT
 - 4K@50/60Hz (4:2:0, 10-bit HDR), AVLC required over HDBaseT
 - Data rates higher than 10.2Gbps



8.5 HDBaseT Features

HDBaseT Feature Set	
Video & Audio	Supported
IR Pass-through	Supported
RS-232 Pass-through	Supported
Accept power from Receiver	Unsupported
Send power to Receiver	Supported
LAN Pass-through	Supported

9. ACRONYMS

ACRONYM	COMPLETE TERM
ADC	Analog-to-Digital Converter
AVLC	Adaptive Visually Lossless Compression
AVR	Audio/Video Recorder or Audio/Video Receiver
Cat.5e	Category 5 (enhanced) cable
Cat.6	Category 6 cable
Cat.7	Category 7 cable
COAX	Coaxial
CEC	Consumer Electronics Control
CLI	Command-Line Interface
DAC	Digital-to-Analog Converter
DHCP	Dynamic Host Configuration Protocol
DVI	Digital Visual Interface
EDID	Extended Display Identification Data
GUI	Graphical User Interface
HD	High-Definition
HDCP	High-bandwidth Digital Content Protection
HDMI	High-Definition Multimedia Interface
HDR	High Dynamic Range
HDTV	High-Definition Television
IP	Internet Protocol
IR	Infrared
LAN	Local Area Network
LPCM	Linear Pulse-Code Modulation
OAR	Optical Audio Return
OLED	Organic Light-Emitting Diode
OPT	Optical
PC	Personal Computer

ACRONYM	COMPLETE TERM
PD	Powered Device
PoH	Power over HDBaseT
PSE	Power Sourcing Equipment
S/PDIF	Sony/Philips Digital Interface Format
SNR	Signal-to-Noise Ratio
THD+N	Total Harmonic Distortion plus Noise
UHD	Ultra-High-Definition
UHDTV	Ultra-High-Definition Television
USB	Universal Serial Bus
VGA	Video Graphics Array
WUXGA (RB)	Widescreen Ultra Extended Graphics Array (Reduced Blanking)



CYPRESS TECHNOLOGY CO., LTD.

www.cypress.com.tw