

The all-in-one video processor with more pixels than you'll ever need.

# CORIOmaster<sup>2</sup>

Industry leading  
**4K/8K performance**



tvONE  
CORIOmaster<sup>2</sup>

192.168.1.20  
CORIOmaster2 - Status OK

CORIOmaster<sup>2</sup>

Captivate your audience with the most powerful video processor on the planet!  
Create the ultimate 4K60 video experiences for your high-profile LED installations,  
projection edge blends or monitor walls.

 tvONE<sup>®</sup>

# The Video Processor Redefined

A truly massive video design canvas allows for unbridled creativity with more 4K60 windows than you ever imagined possible.



- **Huge 12 Gigapixel Design Canvas**

Seamlessly manage multiple walls from a single chassis.

- **Go large and creative**

360° rotation and up to 56 displays with high bandwidth outputs.

- **Multi-user control options**

Choose from software, app, 3rd party control or button panel.

- **Up to 128 video windows**

Up to 64 windows per canvas with 128 windows for the total system.

- **Make it sing**

Embedded audio or external audio connectivity.

- **Source labelling**

Easy identification of IP sources.

CORIOmaster / CORIOmaster<sup>2</sup>

tvONE has delivered video wall excellence since 2011 with the multiple award-winning CORIOmaster. With higher resolutions becoming a standard requirement in many installs, CORIOmaster<sup>2</sup> has been designed from the ground up to give massive performance gains.

Experience **ten times**  
more 4K60 windows!



## Powerful



### Unparalleled Performance

Simultaneously display up to 40 windows in 4K60 with normally one frame of latency.



### Smart Design

Future proofed design to grow with you and featuring a striking front panel that will stand out in any rack!



### Extreme Reliability

5-year warranty and optional dual redundant PSU's - it's easy to see why we are trusted by professionals.

## Creative

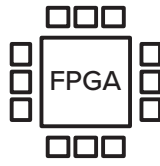

### CORIO Video Processing

Proprietary FPGA technology optimized for 4K60, 4:4:4 outputs and is 8K ready.

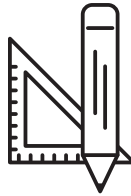

### Design Flexibility

Create mosaics, square walls, expansive edge blends and power your LED walls with pixel-perfect performance.

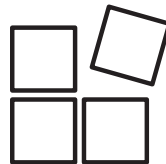

### Modular Platform

Flexible architecture accepts digital, IP, broadcast and legacy AV inputs to exceed requirements.

## Simple



### Simple to Configure

Intuitive and versatile, software - perfect for powerful creative design and control.



### Independent Canvases

12 Gigapixels of design canvas allows three independent working areas for multiple walls.



### Secure Comms

Keep your information safe with HTTPS SSL connectivity and experience RESTful multi-user control with remote monitoring.



# Control Rooms



- **Assured communication**

HTTPS & RESTful API control using software, button panels or 3rd party solutions.

- **IP Stream connectivity**

Low latency H.264 and H.265 IP with mixed feed playlist carousels.

- **Flexible display choice**

Deploy LED, edge blended projectors or display panels. Control multiple walls from a single system.

- **Ultra-reliable**

tvONE exclusive design and manufacturing with a 5-year warranty.

- **Low cost of ownership**

Low power consumption when compared to competitor systems that are based on PC architecture.

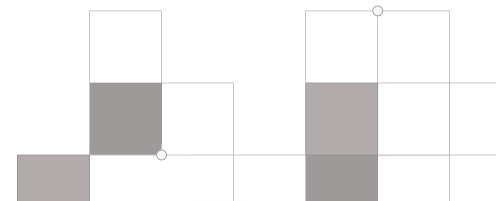

# Corporate



- **See every detail**

Seamless 8K workflows when every detail matters with quad 4K60 stitching.

- **Engage the team**

Eye-catching transitions and animations or seamless video switching.

- **Mix and match**

Source choices include; IP decoding, digital AV, Broadcast, legacy AV or a media player for 4K video and stills.

- **Make it sing**

Embedded audio from source to display or choose external breakout for hook up to external systems.

- **Take control**

Multi-user control options include software, app, 3rd party controllers or our button panel.

- **CORIO inside**

The best up, down and cross conversion in the world!



## Ease of **Control**

Choose from an iOS or Android App to change windows presets, switch video sources or control a host of other settings right from your tablet or mobile.

Other control options include a control button panel, third-party automation plug-ins or CORIOgrapher software.



## 4:4:4 Output **Performance**

Manage your video chroma subsampling for seamless integration with LED walls that require 4:4:4 input. CORIO**master2** can also upsample 4:2:0 or 4:2:2 content to 4:4:4 for maximum flexibility.

doing **LED** right





# Retail & Museums



## ▪ Captivate your audience

Create eye catching walls using LED, projector edge blending or display panels.

## ▪ See every detail

Seamless 8K workflows when every detail matters with quad 4K60 stitching.

## ▪ Go creative

Unlimited 360° rotation of sources and displays and up to 56 screens.

## ▪ Built in media player

Bring 4K video, stills and IP streams to life with our playlist carousels.

## ▪ Make it sing

With embedded audio or external breakout making it easy to get your message heard.

## ▪ Doing LED right

Pixel perfect set-ups with the best in class up, down and cross conversion.

## 8K Workflows

8K is seen as essential in industries that rely on detailed, color accurate reproduction. CORIOmaster2 can seamlessly stitch four 4K60 sources together and deliver them as quad link HDMI 2.0 to an 8K monitor.

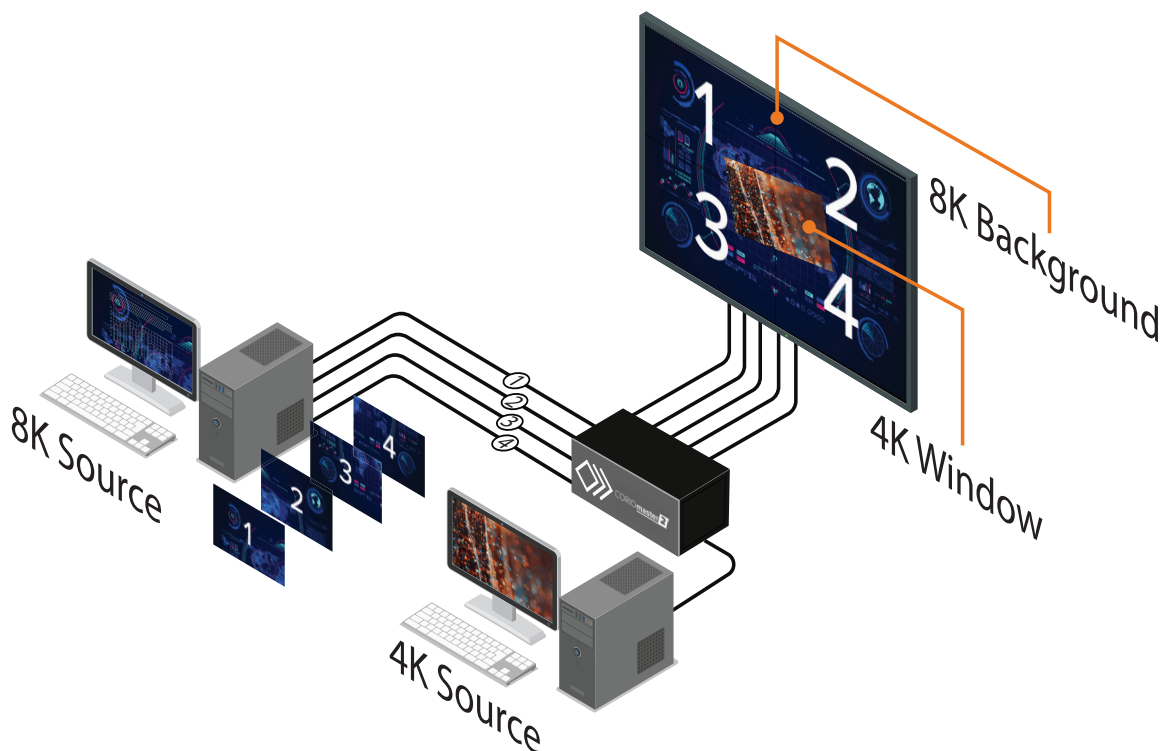



# Broadcast



## ▪ Lifelike video

High bandwidth processing for immersive 4K60 4:4:4 performance.

## ▪ Be creative

Unlimited 360° source and display rotation and up to 56 outputs.

## ▪ Mix and match

Full support for IP, digital AV, broadcast and legacy AV sources.

## ▪ Simple control

Multi-user control options include software, app, 3rd party controllers or our button panel.

## ▪ CORIO inside

The best up, down and cross conversion in the world!

## ▪ Synchronize your videowall

Lock to any input to remove conversion artifacts.

## Best in Class Scaling using **CORIO<sup>®</sup> Technology**

Experience industry leading scaling for HD, 4K and 8K sources with CORIO<sup>®</sup>, our proprietary technology. CORIOmaster2 processes the equivalent of 891 billion video matrix calculations per second with less than two frames of signal delay from input to output, guaranteeing the highest quality video possible with no visible lag.

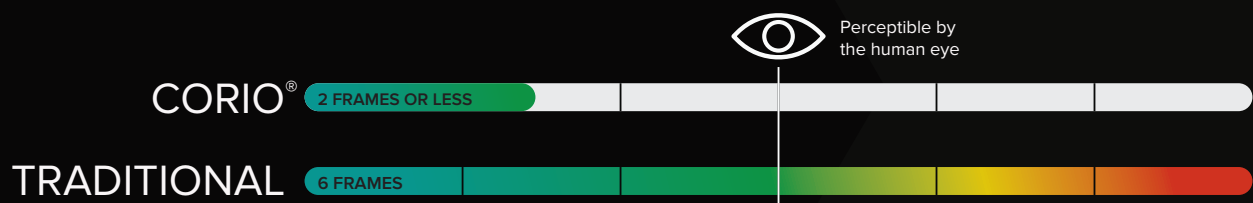

# Rental & Staging



- **Go large**  
Manage multiple walls from a single chassis.
- **Go large and creative**  
360° source and display rotation and up to 56 displays.
- **Every detail matters**  
Support for seamless 8K workflows with quad 4K60 stitching.
- **Eye-catching transitions**  
Window movement and source switching transitions
- **Doing LED right**  
Pixel perfect installations.
- **Ultra-reliable**  
tvONE exclusive design and manufacturing with extreme reliability and 5-year warranty.

## Smart Dynamic Window Layering for **Visual Impact**

A CORIOmaster2 window is a highly flexible video layer that can be independently positioned, layered and have a transition applied.

For maximum flexibility, CORIOmaster2 can have up to 128 video windows on screen at the same time, hidden behind other windows or be ready to bring on screen.

Your favorite windows layouts can be saved as a system preset for quick recall from a PC, button panel, app or automation system.

true pixel power





# Live Events

- **CORIO inside**

The best up, down and cross conversion in the world!

- **Mix and match**

Full support for low latency IP, digital AV, broadcast and legacy AV sources.

- **Demand lip sync perfection**

Best in class video latency for video and IP sources.

- **Future proof your investment**

Modular platform and field upgradeable software.

- **Experience life-like color**

4K60 4:4:4 output performance even with 4:2:0 and 4:2:2 sources.

- **Synchronize your world**

Synchronise your videowall sources to prevent image tearing.



## Doing **LED** Right!

CORIOmaster<sup>2</sup> is the perfect addition for LED installations with best-in-class up and downscaling together, SDI ingest and a huge range of output resolutions

Power multiple LED walls from a single chassis and add multiple windows with animating transitions to create eye-catching appeal on any wall.



# Chassis

CORIOmaster<sup>2</sup> is the modular and field upgradeable solution to future proof your investment.



INPUT MODULES

OUTPUT MODULES



**Dual 4K HDBaseT**  
Supports resolutions up to 4096x2160/60p or 500ft reach with HD-ONE DX500.



**Dual 4K Streaming & Media**  
Dual low latency H.264 & H.265 streaming decoder. IP source labeling. Playback of video clips and stills from on-board 128Gb HDD.



**Quad 3G-SDI Broadcast**  
Supports resolutions up to 3G-SDI (1080/60p) versions.



**Dual 4K HDMI**  
Supports resolutions up to 4096x2160/60p.

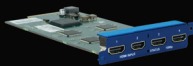

**Quad 1080p HDMI**  
Supports resolutions up to 1920x1080/60p.



**Quad 4K60 HDMI**  
Supports resolutions up to 3840x2160/60p.



**Eight HDMI**  
Supports resolutions up to 1920x1080/60p.



**Dual DVI Universal**  
Supports resolutions up to 1920x1200/60p.



**S/PDIF and Analog Audio**  
Embed and de-embed audio from S/PDIF or analog cross convert digital and analog audio.

## ADAPTORS

For use with legacy AV formats



HDMI



CV



Analog PC

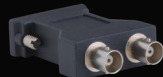

YC (S-Video)



Analog RGBHV



YPbPr/YUV





# EASY YET POWERFUL SETUP



## CORIOgrapher

Our creative video wall software allows ultra-quick videowall set up working in either online or offline modes. Resize and move sources, control media clips or IP streams and control your entire visual experience using presets with our dashboard interface.

## Control

Other options for real-time control include Apps. Control panels or 3rd party control linking to our open source, real-time API.



### tvONE CORIOmaster App

- Available for IOS & Android
- Select custom presets
- Switch sources

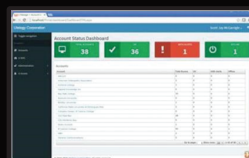

### Infrastructure Control Solutions

- Control an API level function
- API available at [api.tvone.com](http://api.tvone.com)

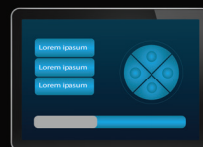

### Automation Control Solutions

- Control any API level function
- API available at [api.tvone.com](http://api.tvone.com)
- Plug-ins for Crestron



### tvONE Hardware Control Panel

- Control an API level function
- US and European form factors
- Supports up to 128 commands

# Accessorize your CORIOmaster<sup>2</sup>

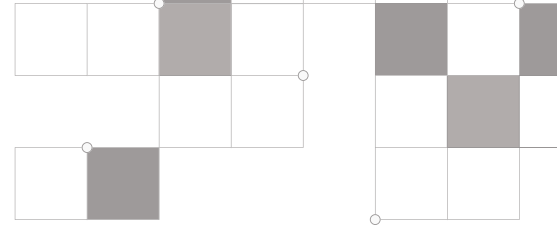





















## Software & Spares

CORIOmaster Software and Apps
<b>CORIO</b> discover
<b>CORIO</b> grapher
<b>CORIO</b> grapher IOS App
<b>CORIO</b> grapher Android App

Automation and Control Plug-ins
Crestron plug-in
RESTful API
Websockets API
Command Line Interface (CLI)

CORIOmaster <sup>2</sup> Spares
Replacement CPU Module
Replacement Inlet Fan Filter
Dual Redundant PSU
Replacement Bonding Module
Blanking Plates
Input Module Union

## Companion Products

<b>IP Encoding</b>	H.264 encoding Magenta encoder 100 		
<b>KVM over IP</b>	1080p KVM Pathfinder 500 Series 	4K KVM Pathfinder 800 Series 	
<b>Wall Plate Transmitters</b>	US form factor MG-WP-611-US 	European form factor MG-WP-611-EU 	
<b>HDMI Extension</b>	HDMI 2.0 Fiber Magenta MG-FB-61x 	HDMI 2.0 Active Optical MG-AOC-66x series 	HDMI over HDBaseT HD-One series 
<b>Pre-input Multi Windowing</b>	IP, HDMI, HDBaseT & 3G-SDI CORIOview series 	3G-SDI or HDMI/DVI/VGA C2-6x04 series 	HDMI or DisplayPort 1T-MV-8474 
<b>HDMI Matrix Solutions</b>	Universal matrix CORIOmatrix 	HDMI 2.0 4x4 MX-6544 	HDMI 2.0 8x8 MX-6588 
<b>HDMI Distribution</b>	Splitter MG-DA-612 	4 Port DA MG-DA-614 	8 Port DA MG-DA-618 
<b>Accessory Rack Mounting</b>	Universal racking, powering & cooling ONERack 		
<b>Hippotizer Media Server</b>	8K Playback at 60FPS. 4x DP 1.2 outputs. Tierra+ 	2x DP 1.2 outputs Montane+ RTX 	6x DP 1.2 or DVI-DL outputs Taiga+ 

Toll Free: 44 (0)1628 566830

sales.europe@tvone.com

www.tvone.com