



CDPS-CS6

Control System Center



Operation Manual

DISCLAIMERS

The information in this manual has been carefully checked and is believed to be accurate. Cypress Technology assumes no responsibility for any infringements of patents or other rights of third parties which may result from its use.

Cypress Technology assumes no responsibility for any inaccuracies that may be contained in this document. Cypress also makes no commitment to update or to keep current the information contained in this document.

Cypress Technology reserves the right to make improvements to this document and/or product at any time and without notice.

COPYRIGHT NOTICE

No part of this document may be reproduced, transmitted, transcribed, stored in a retrieval system, or any of its part translated into any language or computer file, in any form or by any means—electronic, mechanical, magnetic, optical, chemical, manual, or otherwise—without express written permission and consent from Cypress Technology.

© Copyright 2018 by Cypress Technology.

All Rights Reserved.

TRADEMARK ACKNOWLEDGMENTS

All products or service names mentioned in this document are trademarks of the companies with which they are associated.



SAFETY PRECAUTIONS

Please read all instructions before attempting to unpack, install or operate this equipment and before connecting the power supply. Please keep the following in mind as you unpack and install this equipment:

- Always follow basic safety precautions to reduce the risk of fire, electrical shock and injury to persons.
- To prevent fire or shock hazard, do not expose the unit to rain, moisture or install this product near water.
- Never spill liquid of any kind on or into this product.
- Never push an object of any kind into this product through any openings or empty slots in the unit, as you may damage parts inside the unit.
- Do not attach the power supply cabling to building surfaces.
- Use only the supplied power supply unit (PSU). Do not use the PSU if it is damaged.
- Do not allow anything to rest on the power cabling or allow any weight to be placed upon it or any person walk on it.
- To protect the unit from overheating, do not block any vents or openings in the unit housing that provide ventilation and allow for sufficient space for air to circulate around the unit.
- Please completely disconnect the power when the unit is not in use to avoid wasting electricity.

VERSION HISTORY

REV.	DATE	SUMMARY OF CHANGE
RDV1	2016/01/07	Preliminary release
RDV2	2016/04/21	Add WebGUI
RDV3	2016/06/14	Revised trigger event number to 8
VS0	2017/02/21	Updated text/diagrams
VS1	2019/10/04	Added scheduling and additional macro support
VS2	2020/07/29	Full update to revised manual format

CONTENTS

1. Introduction	1
2. Applications	1
3. Package Contents	1
4. System Requirements	2
5. Features	2
6. Operation Controls and Functions	3
6.1 Front Panel.....	3
6.2 Left Side Panel.....	3
6.2 Rear Panel.....	4
6.4 IR Cable Pinouts.....	5
6.5 RS-232/422/485 Pinouts	5
6.6 WebGUI Control	6
6.6.1 Macro Settings Tab.....	8
6.6.2 Extension Macro Tabs 1~3.....	10
6.6.3 Command Settings Tab.....	11
6.6.4 Schedule Settings Tab.....	13
6.6.5 Network Settings Tab	15
6.6.6 System Settings Tab.....	16
6.6.7 Time Settings Tab.....	17
6.7 Telnet Control	18
6.8 Telnet Commands.....	18
7. Connection Diagram	22
8. Specifications	23
8.1 Technical Specifications	23
9. Acronyms	24



1. INTRODUCTION

This Control System Center is ideal for a user who has a wide variety of devices that need to be controlled. It comes with eight external trigger connections which directly activate 8 (of 32 total) user defined macro events stored within the unit. All 32 macros are available to be activated via the WebGUI, or by Telnet. Those user defined macros can send control signals to remote devices via Ethernet, IR, relay, or serial port (RS-232/422/485) allowing for the control of a large array of devices at the push of a button. A battery backed-up clock allows for detailed event scheduling based on a repeating daily/weekly schedule, or single events.

An integrated IR code learning function is also available, allowing the user to store and re-transmit the IR codes sent by nearly any standard IR remote. A number of user control interfaces are available including WebGUI and Telnet. Last but not least, this unit supports PoE (Power over Ethernet) allowing it to be powered directly from a standard PoE network switch, without the need for an external power adapter, allowing for incredible installation flexibility.

2. APPLICATIONS

- 1× Control System Center
- 1× 5V/2.6A DC Power Adapter
- 1× IR Learner/Extender Cable
- 4× IR Blaster Cable
- 7× Terminal Block Connectors
- 1× Operation Manual

3. PACKAGE CONTENTS

- 1× UHD⁺ HDMI/DP over Fiber Transceiver
- 1× 12V/3A DC Power Adapter
- 1× Power Cord
- 1× 3-pin Terminal Block
- 1× Shockproof Feet (Set of 4)
- 1× Operation Manual

4. SYSTEM REQUIREMENTS

- Equipment which can be controlled via Telnet, serial, IR remote or relay.
- An active internet connection from a switch or router for control of Ethernet devices.

5. FEATURES

- 8 trigger inputs linked directly to 8 user macros allowing for instant control activation
- 24 additional macros that can be activated via Ethernet, or on a schedule.
- 4 relay bypasses to control devices such as projector screens, lighting, etc.
- 4 IR outputs to control devices such as TVs, media players, etc.
- Integrated IR code learning functionality
- Battery backed up clock for scheduling events
- Multiple user control interfaces including WebGUI, Telnet and RS-232 / 422/485
- Simple configuration of macros, triggers and relay settings via the WebGUI
- PoE (Power over Ethernet) support
- Firmware can easily be updated in the field via USB

6. OPERATION CONTROLS AND FUNCTIONS

6.1 Front Panel

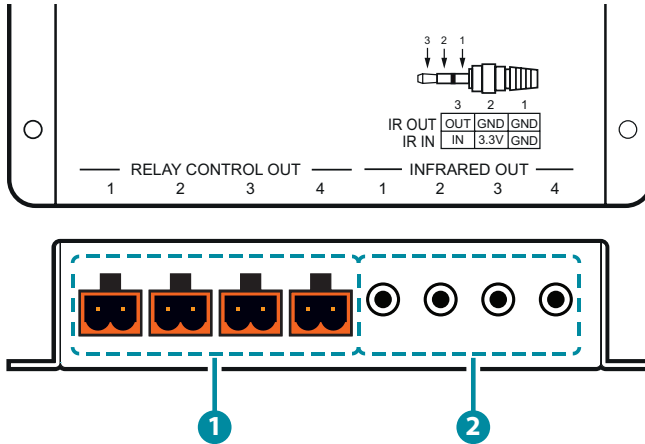

- 1 RELAY CONTROL OUT Ports 1~4:** Connect to devices that support relayed power (0~30VDC/10A or 0~250VAC/10A) activation to control them via macro commands.
- 2 INFRARED OUT Ports 1~4:** Connect to the provided IR Blaster to transmit IR signals to devices within direct line-of-sight of the IR Blaster.

6.2 Left Side Panel

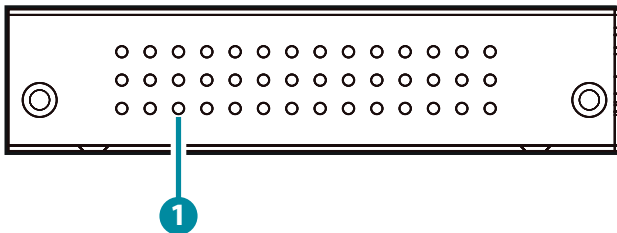

- 1 IP RESET Pinhole:** Use a paperclip to press and hold this recessed button for 10 seconds to reset the IP configuration to the factory defaults.

Note: The unit's default IP address is 192.168.1.50.

6.2 Rear Panel

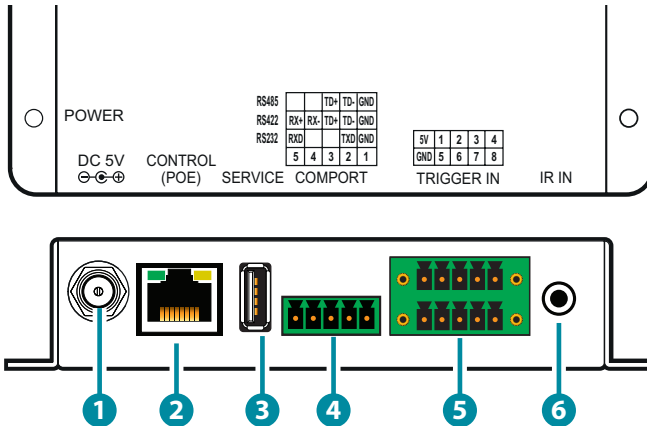

- 1 DC 5V Port:** Plug the 5V DC power adapter into the unit and connect it to an AC wall outlet for power. (Optional)

Note: Not required if the unit is being powered via PoE.
- 2 CONTROL (PoE) Port:** Connect directly, or through a network switch, to your PC/laptop to control the unit via Telnet/WebGUI.

Note: If the unit is connected to a network switch that provides PoE then no power adapter is required to power the unit.
- 3 SERVICE Port:** This slot is reserved for firmware update use only.
- 4 COMPORT Terminal Block:** Connect to the device you wish to control via a 3(or 5)-pin adapter cable to send RS-232/422/485 commands from the unit. Baud rates up to 115200 are supported. For pin connection details please refer to the diagram above.
- 5 TRIGGER IN Terminal Block:** Connect to any device with trigger or switch functionality such as window security alarms, motion detectors, door switches, etc. Each of the 8 trigger inputs will activate the associated macro when triggered. A minimum of 5V DC is required to activate the trigger. For pin connection details please refer to the diagram above.
- 6 IR IN Port:** Connect to the provided IR Extender to allow IR control of the unit or for learning IR commands. Ensure that the remote being used is within direct line-of-sight of the IR Extender.

Note: For additional IR learning details please refer to section 6.6.3.

6.4 IR Cable Pinouts

IR Blaster Cable

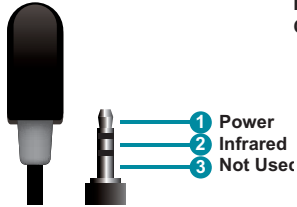

IR Extender Cable

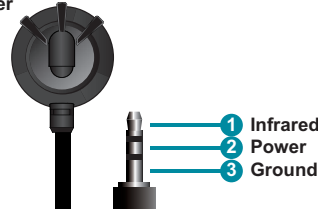

6.5 RS-232/422/485 Pinouts

RS-232

5-pin Terminal Block

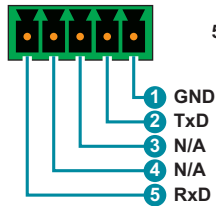

RS-422

5-pin Terminal Block

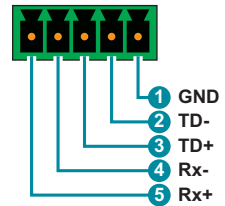

RS-485

5-pin Terminal Block

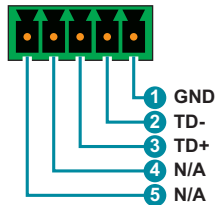

6.6 WEBGUI CONTROL

• Device Discovery

Please obtain the “Device Discovery” software from your authorized dealer and save it in a directory where you can easily find it.

Connect the unit and your PC/Laptop to the same active network and execute the “Device Discovery” software. Click on “Find Devices on Internet” and a list of devices connected to the local network will show up indicating their current IP address.

Note: The unit’s default IP address is 192.168.1.50.

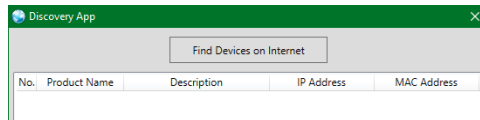

By clicking on one of the listed devices you will be presented with the network details of that particular device.

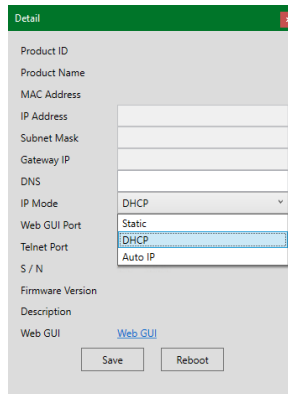

- 1) **IP Mode:** If you choose, you can alter the static IP network settings for the device, or switch the unit into DHCP mode to automatically obtain proper network settings from a local DHCP server. To switch to DHCP mode, please select DHCP from the IP mode drop-down, then click “Save” followed by “Reboot”.
- 2) **WebGUI Hotkey:** Once you are satisfied with the network settings, you may use them to connect via Telnet or WebGUI. The network information window provides a convenient link to launch the WebGUI directly.

- **WebGUI Overview**

After connecting to the WebGUI's address in a web browser, the login screen will appear. Please enter the appropriate user name and password then click "Submit" to log in.

Note: The default user name and password is "admin".

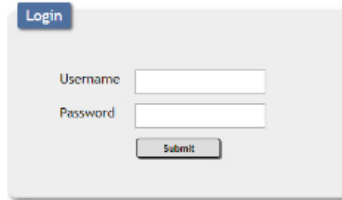

A login form with a blue "Login" button at the top left. Below it are two input fields: "Username" and "Password". At the bottom center is a "Submit" button.

On the left side of the browser you will see the following menu tabs where all primary functions of the unit are controllable via the built in WebGUI. The individual functions will be introduced in the following sections.

- Macro Settings
- Extension Macro 1
- Extension Macro 2
- Extension Macro 3
- Command Settings
- Schedule Settings
- Network Settings
- System Settings
- Time Settings

6.6.1 Macro Settings Tab

Click on the “Macro Settings” tab to execute or edit the settings for the primary macro buttons. These macros can be executed by activating the 8 input triggers on the unit as well as via the WebGUI or Telnet.

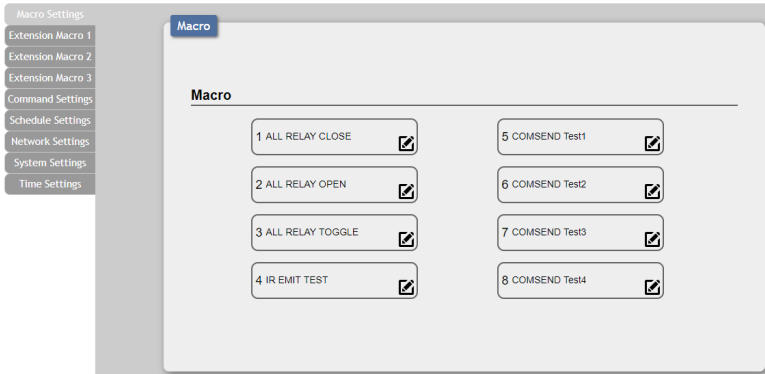

- 1) **Macros 1~8:** These align with Trigger Inputs 1~8. When a trigger is activated the unit will execute the associated macro command.
By default, the unit comes with multiple macros pre-configured for testing the unit’s functionality. These presets are:

- **Macro 1:** Sequentially close Relays 1 through 4 with a 100ms delay.
- **Macro 2:** Sequentially open Relays 1 through 4 with a 100ms delay.
- **Macro 3:** Sequentially toggle the state of Relays 1 through 4 with a 100ms delay.
- **Macro 4:** Sequentially send IR signals from emitters 1 through 4 with a 100ms delay.
- **Macros 5~8:** Send a sample text string over the COM port with a 100ms delay afterwards.

Click on the macro buttons to demonstrate and test the various functions.

- 2) **Macro Edit:** Clicking on the edit icon (✎) in any macro button will open up the Macro Edit window. After all desired changes to the macro have been made, click on the “Save Change” button to commit the changes to memory.

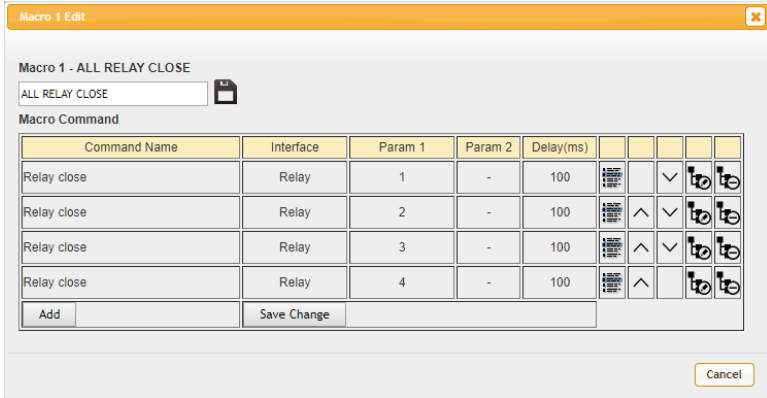

- **Edit Name:** At the top of the Macro Edit window is a text field where you can edit the name of the macro. Type your new macro name into the box and then click the save icon (💾) to save it.
- **Insert Command:** Clicking on the insert command icon (⚙) will add a new command before the current one. The “Command Select” window will open where you can select one of the pre-defined commands from the list. After selecting a command the “Set Destination” window will open to allow the selection of the delay and target interface for the command.

Note: Configuring pre-defined commands is covered in section 6.6.3.

- **Reorder Commands:** Within the Macro Edit window the up/down arrows will move the current command’s position and change the command execution order.
- **Set Destination:** Clicking on the destination edit icon (⚙) allows you to edit the delay and target interface for the command.
 - **Delay(ms):** This setting is the length of time to wait before sending the next command and is set in milliseconds.
 - **Interface:** The interface for sending commands can be set to the unit itself (SysCMD), to a specified IP address (TELNET), to a specified RS-232 port (COM), to a specified IR port (IR) or to trigger a relay port (Relay). Sending commands to devices on the local network, or across the internet requires entering the IP address and network port of the destination device. Once the destination information is complete please click on the “Save Change” button.

Note: It is strongly suggested to not set a delay time less than 100ms for system, RS-232, IR, and relay commands or less than

500ms for Telnet commands to ensure that the command is properly received and executed before the next command is sent.

- **Delete Command:** Clicking on the delete command icon (🗑️) will delete the command.
- **Add Command:** To add a new command to the end of the execution list, click on the “Add” button. The “Command Select” window will open where you can select one of the pre-defined commands from the list. After selecting a command the “Set Destination” window will open to allow the selection of the delay and target interface for the command.

6.6.2 Extension Macro Tabs 1~3

Click on any of the three “Extension Macro” tabs to execute/edit the 24 additional software-only macro buttons. These macros can only be activated via the WebGUI or Telnet. Extension Macro editing is identical to editing macros 1 through 8, please refer to section 6.6.1 for more details.

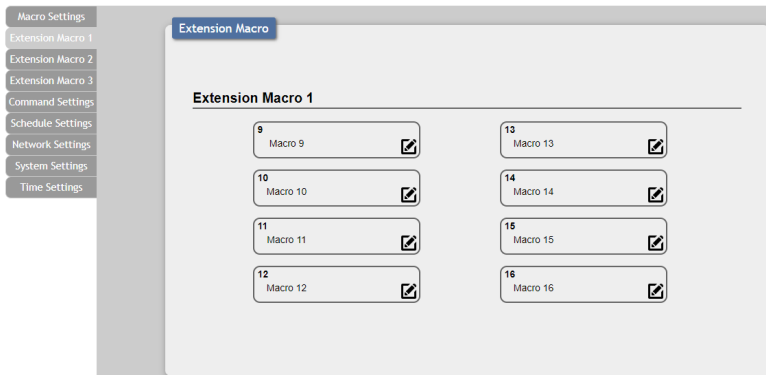

6.6.3 Command Settings Tab

The “Command Settings” tab provides a way to create, edit or delete the commands used by macros. Each command is composed of standard ASCII or HEX data and represents either a system command, relay command, IR code, or telnet/serial port command.

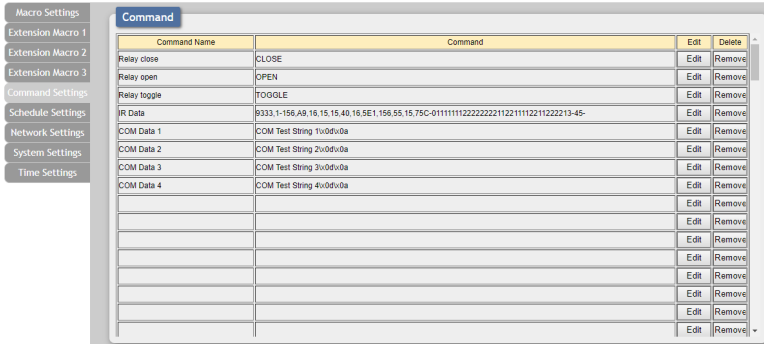

Command Name	Command	Edit	Delete
Relay close	CLOSE	Edit	Remove
Relay open	OPEN	Edit	Remove
Relay toggle	TOGGLE	Edit	Remove
IR Data	3333 1-156,AB,16,15,15,40,16,5E1,156,55,15,75C-0111111122222222112211112211222213-45-	Edit	Remove
COM Data 1	COM Test String 1\x0d\x0a	Edit	Remove
COM Data 2	COM Test String 2\x0d\x0a	Edit	Remove
COM Data 3	COM Test String 3\x0d\x0a	Edit	Remove
COM Data 4	COM Test String 4\x0d\x0a	Edit	Remove
		Edit	Remove
		Edit	Remove
		Edit	Remove
		Edit	Remove
		Edit	Remove
		Edit	Remove
		Edit	Remove

Note: The number of commands that can be stored in the unit is limited by memory and it is generally recommended that commands be under 128 characters long (including spaces). However, if longer commands are needed there is limited support for commands up to 512 characters long. In this case the number of (up to) 512 character commands is limited to 32 and the remaining 96 commands must be under 128 characters.

- Edit Command:** Clicking on the “Edit” button will open up the “Command Edit” window which provides a way to define the contents of each individual command. Once all changes are satisfactory, click on the “Save Change” button to save them into the unit.

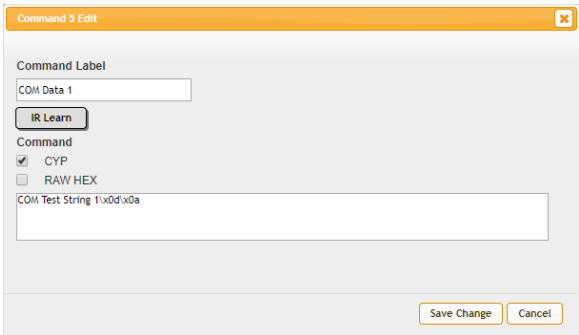

- **Command Label:** Assign a name for the command by entering the text into this field. All commands must have a label.

- **IR Learn:** To learn an IR command, first make sure the included IR Receiver is connected to the unit's IR IN port, then press the "IR Learn" button. After doing this a notice will appear in the WebGUI to send the IR signal within 5 seconds. Point the remote control at the IR receiver and press the button that contains the command you wish to learn. A command string will appear in the text entry window containing the information captured from the IR remote.
- **Command Data:** The command data to send is entered in this text box. The types of commands available and the interface to use with them are detailed below.

Note: Except where explicitly mentioned, the "CYP" format checkbox should always be checked.

- **System Commands (SysCMD Interface): Commands to control** functions of the unit directly using the Telnet functions detailed in section 6.8.

Note: Care must be taken when sending system commands, as they can impact the functionality of the unit itself.

- **Telnet or Serial Commands (Telnet & COM Interfaces):** Simply enter the plain ASCII text of the command in the space provided. Hex codes should be entered using the format: \xHH where "HH" is replaced by an octet pair. For example a standard carriage return would be entered as: \x0D.
- **IR Commands (IR Interface):** Typically this data is automatically filled in by using the IR Learning function, however an IR code may also be manually entered if necessary.

Note: If the IR code is in "Pronto" format the "RAW HEX" checkbox must be checked.

- **Relay Commands (Relay Interface):** Commands to control the state of each relay port. The port to control is assigned during the creation of each individual macro.
 - **CLOSE:** Closes the assigned relay port.
 - **OPEN:** Opens the assigned relay port.
 - **TOGGLE:** Toggles the state of the assigned relay port.

- 2) **Delete Command:** To clear the contents of a command, click on the "Remove" button. The contents will be removed immediately.

Note: There is no "Undo" function! Please use caution when using the "Remove" button!

6.6.4 Schedule Settings Tab

The “Schedule Settings” tab provides multiple ways to automate and schedule the execution of any of the macros defined in this unit. Scheduled events can be individually disabled without deleting the event from the master list.

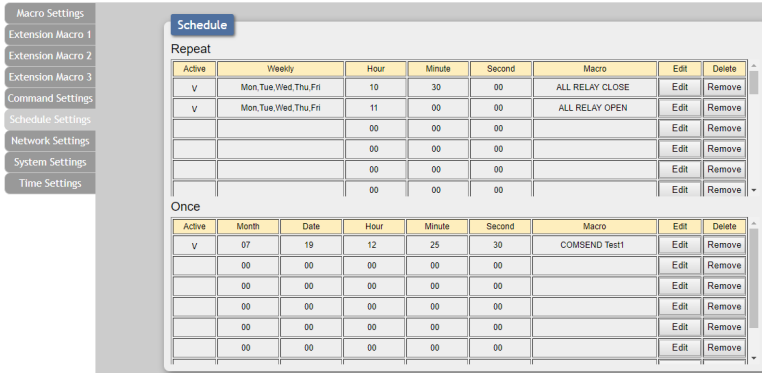

Repeat								
Active	Weekly	Hour	Minute	Second	Macro	Edit	Delete	
v	Mon, Tue, Wed, Thu, Fri	10	30	00	ALL RELAY CLOSE	Edit	Remove	
v	Mon, Tue, Wed, Thu, Fri	11	00	00	ALL RELAY OPEN	Edit	Remove	
		00	00	00		Edit	Remove	
		00	00	00		Edit	Remove	
		00	00	00		Edit	Remove	
		00	00	00		Edit	Remove	

Once								
Active	Month	Date	Hour	Minute	Second	Macro	Edit	Delete
v	07	19	12	25	30	COMSEND Test1	Edit	Remove
	00	00	00	00	00		Edit	Remove
	00	00	00	00	00		Edit	Remove
	00	00	00	00	00		Edit	Remove
	00	00	00	00	00		Edit	Remove
	00	00	00	00	00		Edit	Remove

- 1) **Event Scheduling:** Events can be scheduled to automatically activate at a single set time, or on a repeating schedule.

Note: Each scheduled item must be set as “Active” for it to activate at the scheduled time.

- **Repeat:** Items in this section will execute at their set times on the selected days (Sunday through Saturday) every week as long as they are marked as “Active”.
- **Once:** Items in this section are scheduled to occur a single time at the specified time and date. Each item will automatically change to “None Active” after they have been executed once.

- 2) **Schedule Edit:** To edit an existing scheduled event, or configure a new one, click on the “Edit” button. To delete a scheduled event, click on the “Remove” button.

Note: The available options are slightly different between Repeat and Once events.

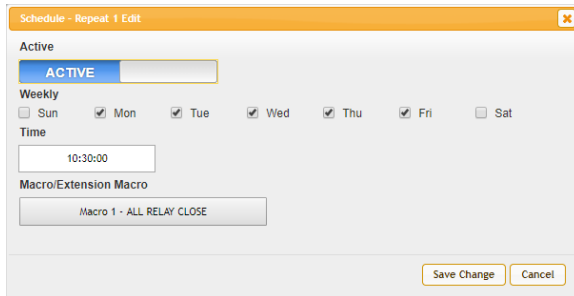

- **Active:** Click this to toggle if the scheduled event is enabled or disabled.
- **Weekly (Repeat Schedule Only):** When editing a repeating event schedule, click the checkboxes next to the days of the week for the event to occur on.
- **Date & Time:** Click within the Time/date box to open up the time/date selection window. Use the available controls to set the activation time (and date, if applicable) for the current event schedule.

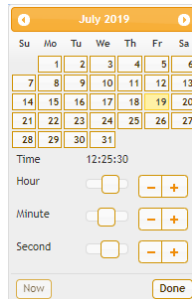

- **Macro/Extension Macro:** Click on this button to open a window displaying all currently defined macros. Select the macro to be executed by the currently selected event schedule.

6.6.5 Network Settings Tab

Click on the “Network Settings” tab to change the network settings for the unit. You can manually set the IP address, netmask and gateway address in “Static IP” mode, or you can obtain an IP address automatically by enabling DHCP.

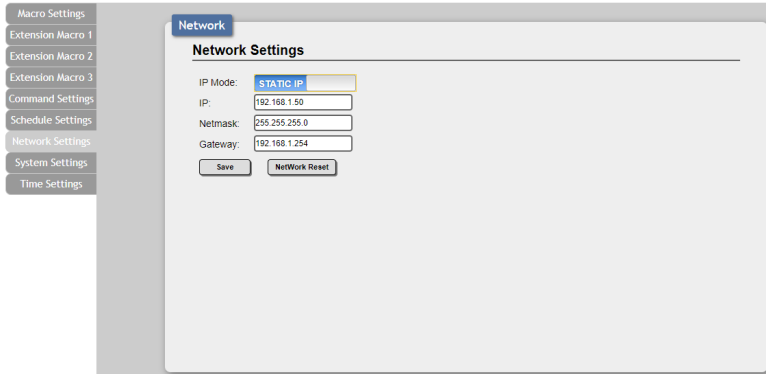

- 1) **Network Settings:** IP mode may be switched between Static IP or DHCP. In Static IP mode the IP, netmask and gateway addresses may be manually set. When in DHCP mode, the unit will attempt to connect to a local DHCP server and obtain IP, netmask and gateway addresses automatically. Please press “Save” after making any changes to the IP configuration or mode. To return all network settings to their defaults, press the “Network Reset” button.

Note: If the IP address is changed then the IP address required for WebGUI/Telnet access will also change accordingly.

6.6.6 System Settings Tab

Click on the “System Settings” tab to make changes to various system settings. From this tab you can change the WebGUI login password and login timeout settings. You may also save the full system configuration, including all macros, to your connected PC/Laptop or restore them from a previously saved configuration. Finally, this tab provides buttons to reset the unit to factory defaults and to reboot the unit.

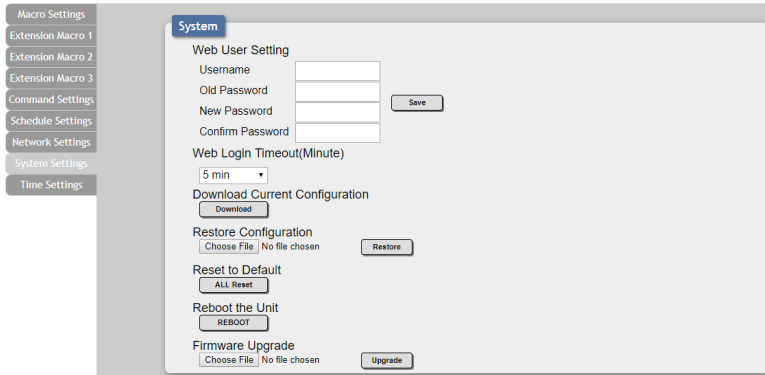

- 1) **Web User Setting:** This section allows for the login password to be changed. The username is “admin” and cannot be changed. The default password is “admin”.
- 2) **Web Login Timeout:** Set the length of time, in minutes, to wait before logging the user out of the WebGUI due to inactivity. This can be set from 5 to 60 minutes.
- 3) **Download Current Configuration:** The current system configuration, including routing and settings, may be saved as an XML file to a PC. Click the “Download” button to save the current system configuration to your local PC. This file will also include all macros, commands, and scheduled events.
- 4) **Restore Configuration:** Previously saved system configurations may be restored from a saved XML file. Click the “Choose File” button to locate the saved XML file, then click the “Restore” button.
- 5) **Reset to Default:** Press the “ALL Reset” button to reset the unit to its factory default state. After the reset is complete, the unit will reboot automatically.

Note: All customized macros, commands, and scheduled events will also be reset to their factory defaults.

- 6) **Reboot the Unit:** Click this button to manually reboot the unit.
- 7) **Firmware Upgrade:** To update the unit's firmware, click the "Choose File" button to open the file selection window and then select the firmware update file (*.bin format) located on your local PC. After selecting the file, click the "Upgrade" button to begin the firmware update process. After the upgrade is complete, the unit will reboot automatically.

6.6.7 Time Settings Tab

The Time Settings tab provides a way to set the system's time, date, and time zone. After setting the system time, the unit will maintain the correct time, even when powered off, due to a battery backed up clock. If your country uses DST (Daylight Saving Time) you can enable or disable it here and configure the start and end times/dates so that your scheduled events will always occur at the correct times throughout the year.

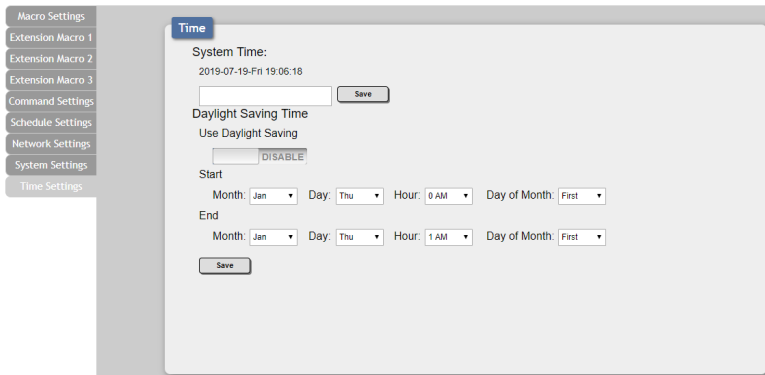

- 1) **System Time:** The unit's time and date can be manually configured here. Click on the empty box to open the time and date configuration screen and select the preferred values. After entering a new time and date, click the "Save" button to store it in the unit and start the clock running.
- 2) **Daylight Saving Time:** Enable or disable the use of DST adjustments for the unit's time.

Note: Enabling Daylight Saving Time while outside the configured DST range will result in no change to the current time.

- **Start:** Set the month, week, day and time for the start of DST in the current time zone.
- **End:** Set the month, week, day and time for the end of DST in the current time zone.

6.7 Telnet Control

Before attempting to use Telnet control, please ensure that both the unit and the PC are connected to the same active networks.

Start your preferred Telnet/Console client, or use the built in client provided by most modern computer operating systems. After starting the client, connect by using the current IP address of the unit and port 23 (if the communication port number used by the unit has not been changed previously). This will connect us to the unit we wish to control and commands may now be entered directly.

Note 1: If the IP address of the unit is changed then the IP address required for Telnet access will also change accordingly.

Note 2: The default IP address is 192.168.1.50 and the default communication port is 23.

6.8 Telnet Commands

COMMAND
Description and Parameters
help ↵ Show the full command list.
? ↵ Show the full command list.
help N1 ↵ Show details about the specified command. N1 = {Command Name}
ipconfig ↵ Show the unit's current IP configuration information.
sipmode N1 ↵ Set the IP address assignment mode. Available values for N1 : STATIC [Static IP mode] DHCP [DHCP mode]

COMMAND	
Description and Parameters	
sipaddr N1 ←	
Set the unit's static IP address.	
N1 = X.X.X.X	[X = 0~255, Static IP address]
snetmask N1 ←	
Set the unit's static netmask.	
N1 = X.X.X.X	[X = 0~255, Static netmask]
sgateway N1 ←	
Set the unit's static gateway address.	
N1 = X.X.X.X	[X = 0~255, Static gateway address]
telnet_timeout N1 ←	
Enable or disable the Telnet timeout.	
Available values for N1 :	
ON	[Timeout enabled]
OFF	[Timeout disabled]
eth_fadefault ←	
Reset the unit's network settings to the factory defaults.	
ver ←	
Show the unit's current firmware version.	
fadefault ←	
Reset the unit to the factory defaults.	
reboot ←	
Reboot the unit.	
relay N1 N2 ←	
Open, close, or toggle the specified relay.	
N1 = 1~4	[Relay port]
Available values for N2 :	
OPEN	[Open the relay]
CLOSE	[Close the relay]
TOGGLE	[Toggle the relay]

COMMAND	
Description and Parameters	
iremit ir N1 0 N2	
Emit the specified IR command data from the specified IR output port.	
N1 = 1~4	[IR output port]
N2 = {IR data}	[CYP format data]
irlearn 0	
Initiate the unit's IR capture function. The captured code will be displayed in CYP format.	
macro run N1	
Run the specified macro immediately.	
N1 = 1~32	[Macro number]
macro stop	
Stop the execution of the current macro.	
comconf N1 N2 N3 N4 N5	
Set the serial port format, baud rate, data bits, parity and stop bits of the serial port.	
Available values for N1 :	
RS232	[RS-232 signal format]
RS422	[RS-422 signal format]
RS485	[RS-485 signal format]
Available values for N2 :	
4800	[4800 baud]
9600	[9600 baud]
19200	[19200 baud]
38400	[38400 baud]
57600	[57600 baud]
115200	[115200 baud]
250000	[250000 baud]
1000000	[1000000 baud]
N3 = 7~8	[Data Bits]
Available values for N4 :	
NONE	[No parity]

COMMAND	
Description and Parameters	
ODD	[Odd parity]
EVEN	[Even parity]
N5 = 1	[Stop Bits]
comsend N1 ↵	
Transmit the specified ASCII data content over the serial port.	
N1 = {ASCII data}	[ASCII text, up to 512 characters]
trigger status ↵	
Show the current state of all triggers on the unit.	
trigger info ↵	
Show the current configurations of all triggers on the unit.	
trigger info N1 ↵	
Show the current configuration of the specified trigger.	
N1 = 1~8	[Trigger port]
trigger mode N1 N2 ↵	
Set the activation mode of the specified trigger.	
N1 = 1~8	[Trigger port]
Available values for N2 :	
RAISING	[Trigger on low to high change]
FALLING	[Trigger on high to low change]
CHANGE	[Trigger on a change in state]
trigger active N1 N2 ↵	
Enable or disable the specified trigger.	
N1 = 1~8	[Trigger port]
Available values for N2 :	
ENABLE	[Enable trigger]
DISABLE	[Disable trigger]

Note: Commands will not be executed unless followed by a carriage return. Commands are not case-sensitive.

7. CONNECTION DIAGRAM

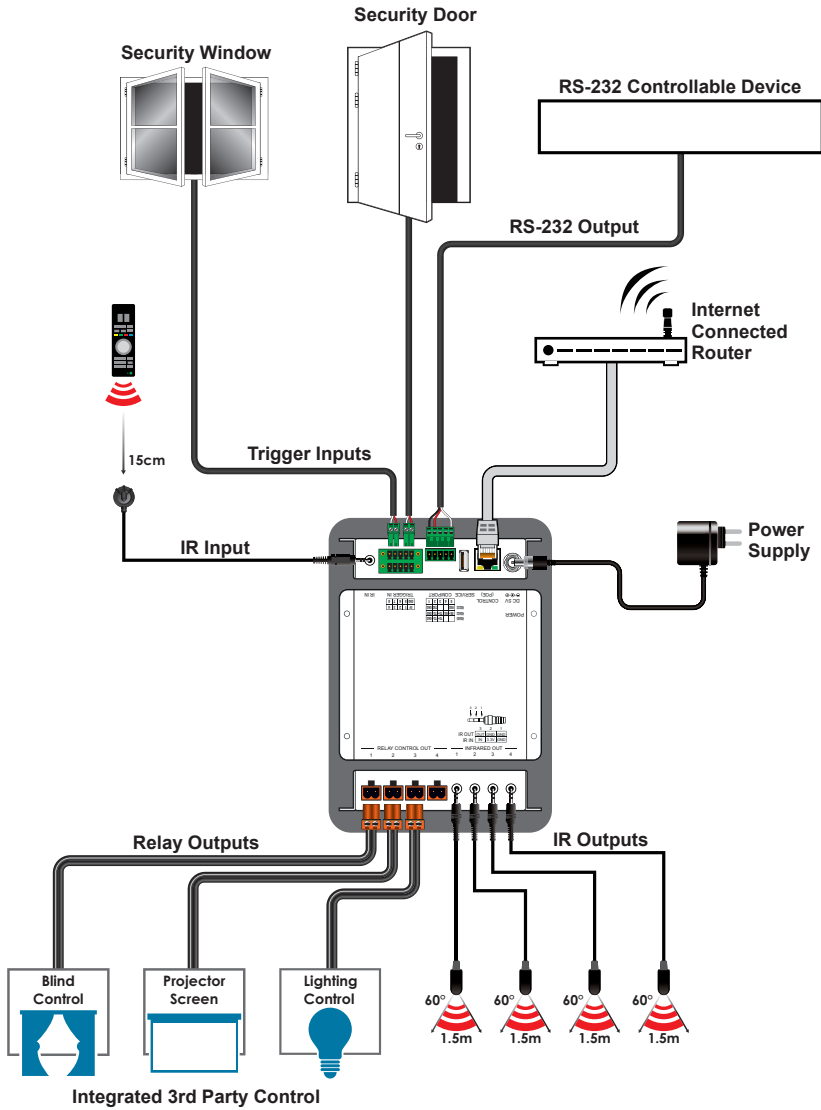

8. SPECIFICATIONS

8.1 Technical Specifications

Input Ports	1×IR Learner/Extender (3.5mm) 8×Trigger (10-pin Terminal Block)
Output Ports	4×IR Blaster (3.5mm) 4×Relay (2-pin Terminal Block) 1×Serial (5-pin Terminal Block)
Pass-through Ports	1×IR Extender (3.5mm) 1×IR Blaster (3.5mm) 1×RS-232 (DE-9) 1×LAN (RJ-45)
Control Ports	1×IP Control (RJ-45)
Service Port	1×USB 2.0 (Type-A)
IR Frequency	30 ~ 50kHz (30 ~ 60kHz under ideal conditions)
Baud Rate	Up to 115200
Power Supply	5V/2.6A DC or PoE (US/EU standards, CE/FCC/UL certified)
ESD Protection (HBM)	±8kV (Air Discharge) ±4kV (Contact Discharge)
Dimensions (W×H×D)	128mm×25mm×108mm [Case Only] 128mm×25mm×118mm [All Inclusive]
Weight	400g
Chassis Material	Metal (Steel)
Chassis Color	Black
Operating Temperature	0°C – 40°C/32°F – 104°F
Storage Temperature	-20°C – 60°C/-4°F – 140°F
Relative Humidity	20 – 90% RH (Non-condensing)
Power Consumption	3.63W

9. ACRONYMS

ACRONYM	COMPLETE TERM
ASCII	American Standard Code for Information Interchange
Cat.5e	Enhanced Category 5 cable
Cat.6	Category 6 cable
Cat.6A	Augmented Category 6 cable
Cat.7	Category 7 cable
CLI	Command-Line Interface
COM	Communication
DHCP	Dynamic Host Configuration Protocol
GUI	Graphical User Interface
IP	Internet Protocol
IR	Infrared
kHz	Kilohertz
LAN	Local Area Network
LED	Light-Emitting Diode
PD	Powered Device
PoE	Power over Ethernet
PSE	Power Sourcing Equipment
TCP	Transmission Control Protocol
USB	Universal Serial Bus



CYPRESS TECHNOLOGY CO., LTD.
www.cypress.com.tw
