

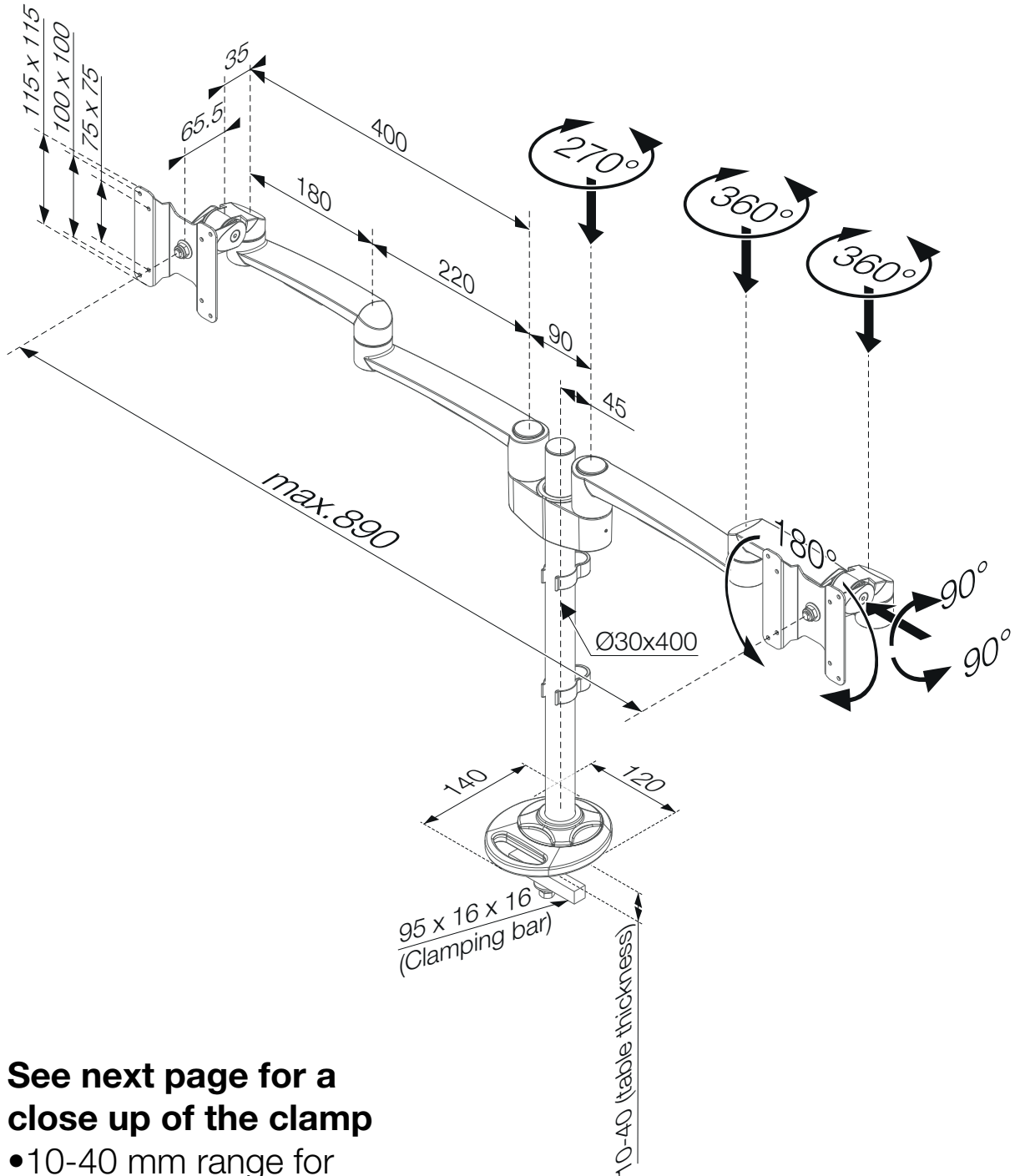

- 438-LC28
- 438-LC28W
- 438-LC28B

Monitor Arm Oslo - System 2 with grommet mount

Oriented View



See next page for a close up of the clamp

- 10-40 mm range for table thickness.



- 438-LC28
- 438-LC28W
- 438-LC28B

Monitor Arm Oslo - System 2 with grommet mount

Oriented View

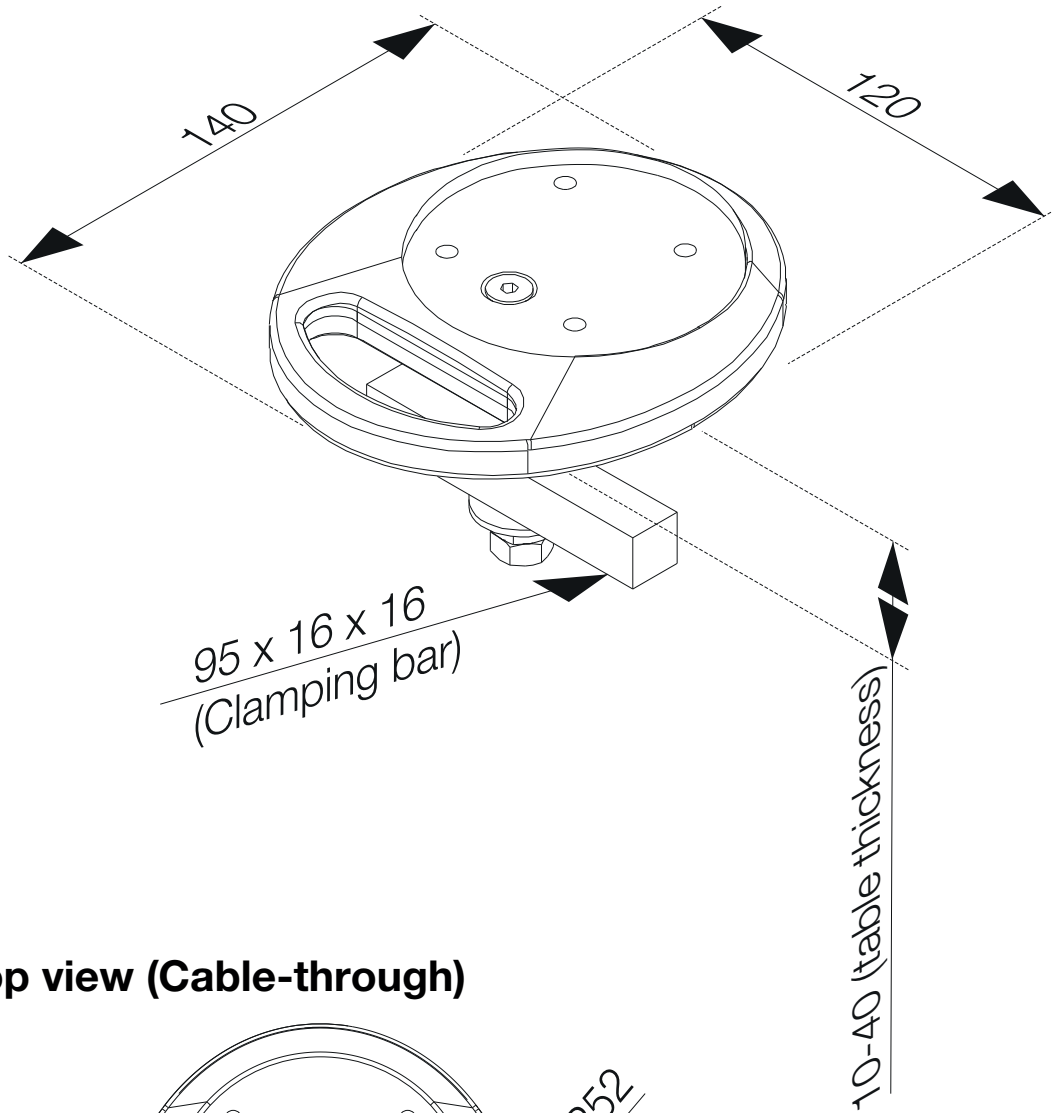

Top view (Cable-through)

