

436-FXKIT2

# Toolbar System, with one toolbar kit (1600 mm), incl. twin pole kit (420 mm)

## Oriented view

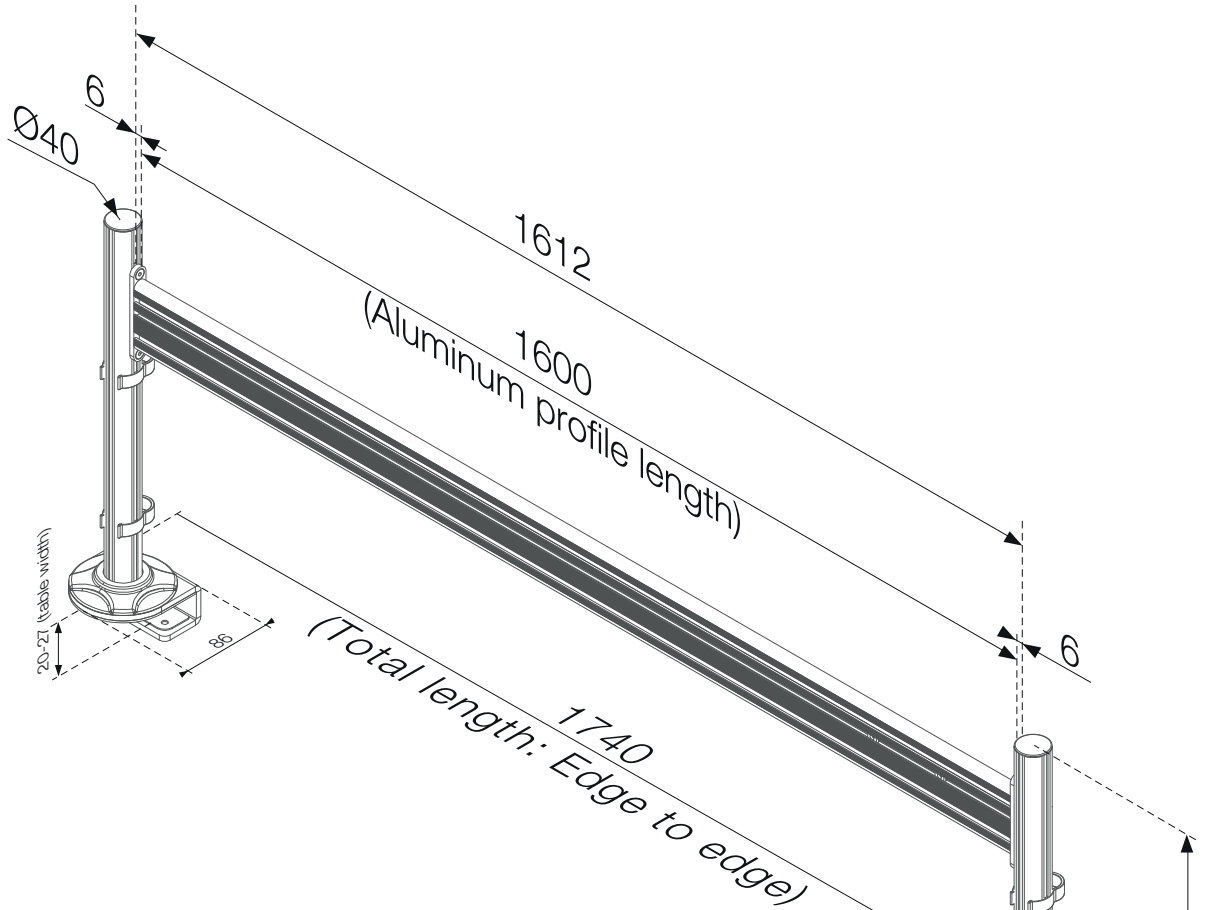

## Side view (Aluminum profile)

