

# Cable Tray Expand

- a** - Table installation  
**b** - Desk screen installation

- 429-FX05  
 □ 429-FX05W  
 ■ 429-FX05B



## CONTENT:

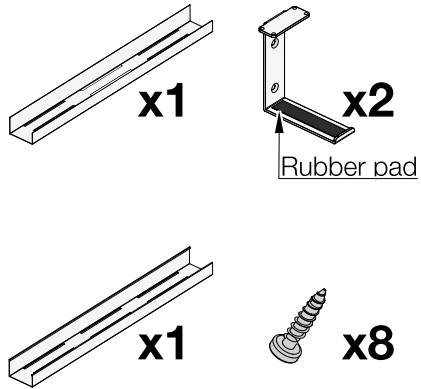

- 1** FLANGE OF TRAY BEARING BRACKETS  
 Keeping the flange by the exterior of the trays facilitates extending and contracting the trays to ANY length (**blue flange**).  
 If the flange is to be hidden (**red flange**), please use matrix **!**

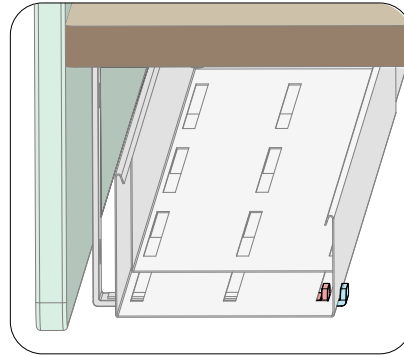

- 2a** ATTACH TO TABLE  
 Measure up the desired distance and mount the tray bearing brackets as planned using all 4 wood screws. Make sure to align the two brackets as parallel as possible.

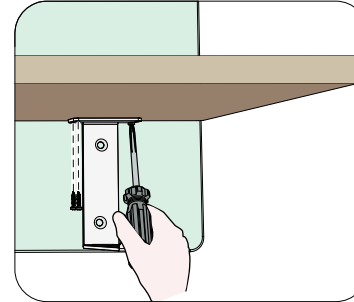

- 2b** ATTACH TO SCREEN  
 Measure up the desired distance and mount the tray bearing brackets as planned using four countersunk Ø6 mm wood screws (**not incl.**). Make sure to align the two brackets as parallel as possible.

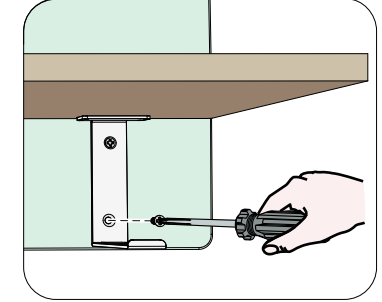

- 3** DIRECTION OF CABLE TRAY  
 Decide on which direction the trays should be facing. See both options below. **Option 2** is advantageous to keep the cables hidden while **Option 1** makes it easier to route cables under the table.

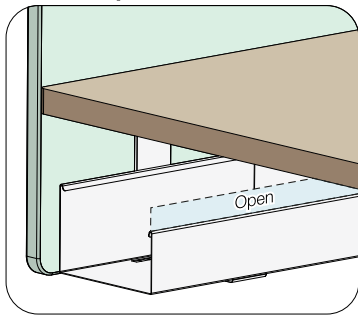

**Option 1:** Cable trays closed towards the back and open towards the front.

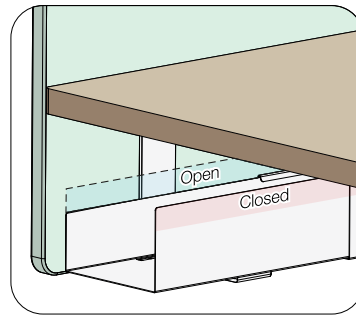

**Option 2:** Cable trays closed towards the back and open towards the front.

- 4** TILT AND INSTALL  
 Use the rubber pieces of the bearing bracket as well as the table as support to keep the trays still in a tilted position. This facilitates installing the desired components into the tray.

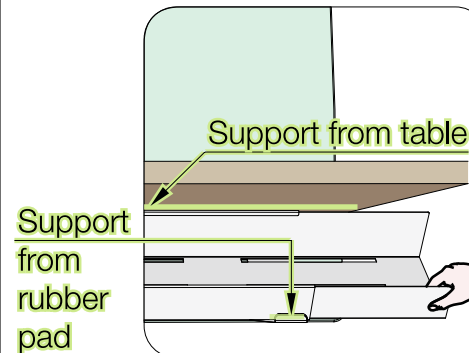

- !** MATRIX TO KEEP FLANGE HIDDEN

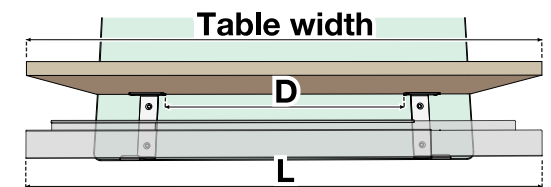

Table width	L	D <sub>max</sub> - D <sub>min</sub>
1800	1800	1570 - 1270
	1750	1520 - 1220
1600	1600	1350 - 1070
	1550	1320 - 1020
1400	1400	1150 - 870
	1350	1120 - 820
1200	1200	970 - 730
	1150	920 - 760